

Design Guide & Specification

- Residential and Industrial Estates Development



Design Guide & Specification

Residential and Industrial Estates Development

Contact Details:



Darlington Borough Council
Harry Alderton tel.01325 388748



Hartlepool Borough Council
Ken Carney tel.01429 523246



Middlesbrough Borough Council
Steve Binks tel. 01642 728156



Redcar and Cleveland Borough Council
Tony Lewis tel.01287 612537



Stockton-on-Tees Borough Council
Jane Salisbury tel.01642 526727

Design Guide & Specification

Residential and Industrial Estates Development

DEFINITIONS:

For the purposes of this document the following definitions shall apply:

The Engineers are:

Darlington Borough Council
John Ray
Highways Manager
Development and Environment Department
Hopetown House
Brinkburn Road
Darlington
DL3 6ED

Hartlepool Borough Council
Head of Technical Services
Hartlepool Borough Council
Bryan Hanson House
Hanson Square
Hartlepool
TS24 7BT

Middlesbrough Borough Council
Ian Busby, BSc., C.Eng., M.I.C.E.,
Highway Services Manager
Transport and Design Services
Middlesbrough Council
PO Box 65
Vancouver House
Gurney Street
Middlesbrough
TS1 1QP

Redcar and Cleveland Borough Council
Brian McLean, BSc, C.Eng, M.I.C.E, M.I.H.T,
MBA
Head of Highways and Transportation,
Area Management
Redcar and Cleveland Borough Council
Belmont House
Rectory Lane
Guisborough
TS14 7FD

Stockton-on-Tees Borough Council
Mike Robinson, BSc., C.Eng., M.I.C.E.,
Head of Engineering and Transportation
Environment and Transportation Division
Stockton-on-Tees Borough Council
PO Box 229
Kingsway House
West Precinct
Billingham
TS23 2YL

Design Guide & Specification

Residential and Industrial Estates Development

The Developer is: The party or parties entering into an agreement with the Highway Authority for the construction of works proposed for adoption under the Highways Act 1980.

Note: For both design and construction phases of a development, it is anticipated that responsibility for making day-to-day decisions in relation to the application of standards laid down in this document will be delegated by the above parties to appropriately qualified and authorised engineering staff under their control.

In the case of the Engineer, this responsibility is delegated to members of the Highway Maintenance Team with Transport and Design Services.

The Developer will normally delegate this responsibility to directly employed personnel, however, if an external agent is appointed (such as a consultant or contractor) and the Developer wishes to pursue this party to have delegated authority, the Engineer must be advised in writing at the earliest opportunity.

Design Guide & Specification

Residential and Industrial Estates Development

AMENDMENTS

Clause	Amendment	Date Amended
3.8.3	Drawings to be sent electronically	Mar 06
5.4.10	Vehicle Crossing Gradient	Mar 06
10.7.1	Quality Assurance Schemes	Mar 06
10.7.3	Blast furnace slag included	Mar 06
10.7.4	Sasobit included	Mar 06
10.8	Clause re-written	Mar 06
10.10	Modular blocks reinstatement	Mar 06
11.13	Paragraph regarding DNO's included	Mar 06

Design Guide & Specification

Residential and Industrial Estates Development

LOCAL VARIATIONS

The following represent variations to the text for developments within Darlington Borough Council only:

(i) In para 2.8 the contact for Secured by Design is the Community Safety Branch, Durham Constabulary, Police Headquarters, Aykley Heads, Durham, DH1 5TT (Tel. 0191 3752175)
<http://www.durham.police.uk/local/darlington.php>

(ii) In para 12.6.2 carriageway gully pots shall be 450mm internal diameter and 900mm internal depth.

The following represent variations to the text for developments within Middlesbrough Borough Council and Stockton on Tees Borough Councils only:

In 11.5 COLUMN PROTECTION/IDENTIFICATION

Para 3

On completion of painting the column shall be provided with an individual Identification number as follows:-

Prior to adoption an external identification plate is to be provided at a mounting height of 2.5

metres secured by an agreed fixing mechanism indicating:

- Unique column reference
- Ownership- Local Authority
- Contact information in regards to faults.

Indelible label is to be secured onto the wooden back board inside the column indicating unique column reference No and column installation date

CONTENTS

<i>SECTION</i>	<i>TITLE</i>	<i>PAGE</i>
1	<u>INTRODUCTION</u>	2
2	<u>AIMS OF THE DESIGN</u>	3
3	<u>ADOPTION PROCEDURE AND POLICY</u>	6
4	<u>STATUTORY REQUIREMENTS</u>	15
5	<u>DESIGN GUIDE FOR RESIDENTIAL DEVELOPMENTS</u>	20
6	<u>DESIGN GUIDE FOR INDUSTRIAL DEVELOPMENTS</u>	51
7	<u>DESIGN GUIDE FOR PARKING STANDARDS</u>	58
8	<u>DESIGN GUIDE FOR TRAFFIC CALMING</u>	80
9	<u>DESIGN GUIDE FOR CYCLE FACILITIES</u>	93
10	<u>SPECIFICATION FOR ROAD AND FOOTPATH CONSTRUCTION</u>	111
11	<u>DESIGN GUIDE AND SPECIFICATION FOR STREET LIGHTING</u>	185
12	<u>DESIGN GUIDE AND SPECIFICATION FOR HIGHWAY DRAINAGE</u>	203
13	<u>DESIGN GUIDE AND SPECIFICATION FOR HIGHWAY VERGES</u>	221
14	<u>DESIGN GUIDE AND SPECIFICATION FOR STREET NAMEPLATES</u>	234

1. INTRODUCTION

- 1.1 This document replaces and broadens the coverage of the Design Guide and Specification (Residential and Industrial Estates Development) Edition no. 7 published by Cleveland County Council in July 1995. It has been produced by a working group comprising Engineers and Planners from the successor Authorities of Hartlepool, Middlesbrough Council, Redcar and Cleveland and Stockton-on-Tees Borough Councils and Darlington Borough Council.
- 1.2 Note that throughout this document, for Developer read Developer/Contractor.
- 1.3 The Guide indicates the minimum standards of the Highway Authority to ensure adoption under Section 38 of the Highways Act 1980. However, they are not intended to preclude any requirement for a higher standard which may be deemed necessary by a Planning Authority. Adherence to the standards set out in the document will ensure that the Highway Authority is willing to adopt the new highways on completion. When the application of these standards may be unduly inhibiting due to environmental factors or other site constraints, the Developer should discuss the possibility of relaxation of the standards with the Engineer.
- 1.4 This document is intended to be used by architects, engineers, planners and developers involved in the preparation of schemes for new development. It is not intended to be a prescriptive document, although it does set certain standards (as indicated in 1.3 above) which will normally be required as a condition for adoption of new highways.

It is further intended that new ideas and approaches to design problems should not be suppressed. Developers and their designers are urged to discuss their ideas with the Highway/Planning Authority at an early stage in the scheme.

- 1.5 Developers will find it helpful to establish at the outset the relevant policy context for any proposed development as set out in the Local Plan for the area. Similarly, the site may be subject to a development brief, the requirements of which will need to be met.

Any queries relating to this document must be brought to the attention of the Engineer at the earliest opportunity, and a decision obtained before further work proceeds
--

CONTENTS

<i>CLAUSE</i>	<i>TITLE</i>	<i>PAGE</i>
2.1	<u>INTRODUCTION</u>	4
2.2	<u>EXISTING GUIDANCE</u>	4
2.3	<u>SUSTAINABILITY</u>	4
2.4	<u>ACCESS TO PROPERTIES</u>	4
2.5	<u>DESIGN CONCEPT FOR DEVELOPMENT</u>	5
2.6	<u>INTEGRATION AND PHASING OF NEW DEVELOPMENT</u>	5
2.7	<u>DESIGN SOLUTIONS</u>	5
2.8	<u>SECURED BY DESIGN</u>	5

2.

2.1 INTRODUCTION

The design of any new development requires care and sensitivity to ensure the highest possible environmental standards are secured. This guide is intended to assist developers setting out the basic principles which should be followed in terms of providing safe, convenient and functionally effective road, footpath and cycle routes, whilst ensuring that they contribute to the overall attractiveness of the site and its setting.

2.2 EXISTING GUIDANCE

Whilst there are some variations, the standards contained in the guide are generally based on information contained in the following documents:-

- a)* Roads and Traffic in Urban Areas (Institution of Highways and Transportation with the Department of Transport) 1987 superseded by 'Transport in the Urban Environment' June 1997.
- b)* Design Bulletin 32 2nd Edition – Residential Roads and Footpaths (DoE/DoT) 1992.

Supplementary information is available in "Places, Streets and Movement – A companion guide to Design Bulletin 32" published by the Department of the Environment, Transport and the Regions in September 1998.

In regard to parking and transportation issues, consideration has been given to the guidance in Planning Policy Guidance Note 13 (PPG13).

2.3 SUSTAINABILITY

The location, layout and design of new developments, all have implications for sustainability and the principles of the Government's Transport White Paper (July 1998) should be incorporated in the design. Travel patterns and car usage, together with domestic energy consumption, are particularly significant for global warming.

This guide deals with the local aspects of development and in doing so addresses aspects of sustainability such as traffic calming and the natural environment.

Techniques and policies for achieving desirable patterns of energy use arising from development are still emerging and the guide, at this stage, does not include explicit guidance on this issue.

2.4 ACCESS TO PROPERTIES

In planning the layouts of developments, particular attention must be given to affording ease of access to individual properties (whether by car, on foot or by cycle) and convenient access to community facilities and services.

The layout should, however, avoid creating a system which invites use as short cuts and minimises the threat of excessive traffic flows or inconsiderate vehicle speeds.

2.5 DESIGN CONCEPT FOR DEVELOPMENT

Making full and cost effective use of developable land is clearly a desirable planning objective. However, this must be balanced with regard to ensuring satisfactory design, use of materials, and the protection and introduction of significant landscape features to enhance the development. None of these aspects of development should be considered in isolation but form part of an integrated design approach.

2.6 INTEGRATION AND PHASING OF NEW DEVELOPMENT

The integration of new development into established townscape presents special challenges. Development of large sites by phasing demands care and consideration. An overall design concept, with which successive stages of development comply, should be established at an early stage.

2.7 DESIGN SOLUTIONS

New proposals will, in most circumstances, require to be in sympathy with and respectful of the character of established development. However, there may be instances where development can make a positive design statement in its own terms.

2.8 SECURED BY DESIGN

The concept of crime prevention, through environmental design, is rapidly gaining recognition as an economical and effective means of combating crime at the initial design and planning stage of new developments.

Where security and safety measures are built in, considerable economies can be made over the costs of applying surface security.

Aspects of design that can be radically affected by considerations of security are estate or complex layout, vehicular access routes, landscaping and lighting.

Cleveland Constabulary are fully committed to the concept of designing out crime and the aim of improving the quality of life in the community.

In order to more fully appreciate development and planning considerations in design, Cleveland Constabulary Crime Prevention Department is supported by a specialist Architectural and Planning Liaison Officer offering a Consultancy service to Planners, Architects and Developers.

If you would like more information, please contact the Community Safety Department, Police Headquarters, Ladgate Lane, Middlesbrough (Tel 01642 303170). <http://www.cleveland.police.uk/>

CONTENTS

CLAUSE	TITLE	PAGE
3.1	<u>GENERAL</u>	7
3.2	<u>PLANNING APPROVALS</u>	7
3.3	<u>ADVANCE PAYMENTS CODE</u>	7
3.4	<u>SECTION 278 AGREEMENTS</u>	8
3.5	<u>SECTION 38 AGREEMENTS</u>	8
3.6	<u>NEW ROADS AND STREET WORKS ACT</u>	9
3.7	<u>SUBMISSION REQUIREMENTS</u>	10
3.8	<u>ISSUING OF CERTIFICATES</u>	12
3.9	<u>MAINTENANCE PERIOD</u>	13
3.10	<u>ADOPTION PROCEDURE</u>	14

3. ADOPTION PROCEDURE AND POLICY

3.1. GENERAL

The Highway Authority will adopt highways (to include carriageways, footways, verges, footpaths and cycleways all incorporating suitable drainage and lighting) maintainable at public expense, provided that such highways are constructed in accordance with the standards contained in this document and are subject to an Agreement under Section 38 of the Highways Act 1980.

3.2. PLANNING APPROVALS

The Developer will be required to obtain all necessary outline and full planning approvals, in connection with all aspects of the development.

It is important for developers to appreciate that obtaining a planning consent does not imply that a layout is suitable for adoption. It is recommended that the Engineer is consulted about areas to be adopted at an early stage.

3.3. ADVANCE PAYMENTS CODE

The legislation is dealt with in Sections 219 to 225 of the Highways Act 1980 and was enacted in order to ensure that when new buildings are constructed, the roads which service those buildings may be adopted by the Highway Authority without placing a financial burden either on the Authority or on the owner of the premises then fronting onto the street.

The advance payment code exists for ensuring that a payment is made, or security is provided, by a developer to cover the future need to 'make up' the street and to enable frontages to require the adoption of the street, when development has reached a certain stage.

The procedure to be followed is that the Highway Authority must, within 6 weeks from the passing of Building Regulation plans, serve a Section 220 Notice on the person on whose behalf the plans were deposited, requiring the payment or the security under Section 219, of a sum specified in the Notice.

The sum specified is that which would be recoverable, in respect of the frontage of the development, if the Authority were to carry out the works required to bring the street up to a maintainable standard.

Developers can discharge their obligations under the Code by completing a Section 38 Agreement. Even though it may be proposed to complete such an Agreement, it is still an offence to commence building work (including foundations) before the Agreement is sealed by both Developer and Bondsman.

A developer who wishes to commence building before the Agreement is sealed should either;

- (a) Obtain a temporary bond from the surety and lodge this with the Highway Authority.

- or (b) Deposit cash with the Highway Authority for those dwellings upon which it is intended to start work. If the Section 220 Notice specifies the sum for the whole development, this sum will be broken down upon request, to identify specific phases of development. Deposits made in this way, will upon completion of the Agreement, be refunded to the Developer together with accrued interest.

In respect of any notice served by the Authority, other than one specifying no sum to be payable, the Developer has the right of appeal to the Minister (Section 220 (6)).

3.4. SECTION 278 AGREEMENTS

Where a development involves works requiring either improvement or alteration to the existing highway, the Developer may be required to enter into an agreement with the relevant Council as Highway Authority under Section 278 of the Highways Act 1980 and is in addition to the requirements of a Section 38 Agreement. The Developer is advised to discuss at the earliest opportunity the requirements for a Section 278 Agreement, since this invariably takes a longer time to process than Section 38 Agreements. This requirement often occurs as a condition on the grant of planning permission. A Section 278 Agreement, which will need to be supported by a bond, requires the Developer to pay a sum to the Highway Authority for it to carry out the necessary improvement works. Where a Section 278 Agreement is required, this must be signed at the same time as or before the Adoption Agreement under Section 38 is signed.

3.5. SECTION 38 AGREEMENTS

3.5.1. General

When the Developer wishes to enter into an Agreement under Section 38 Highways Act 1980, written application is to be made to the Engineer, who will prepare the legal documentation which is to be signed by the Developer, the Surety and the Council and then sealed.

The Developer should note that the Council's standard Adoption Agreement is based on the National Agreement published by the Association of Metropolitan Authorities on behalf of the Local Authorities Association and the House Builders Federation.

Early consultation with the Highway Authority is recommended to ensure that the development proposals satisfy the design requirements and will be suitable for adoption.

When submitting plans to the Engineer for initial consideration 2 copies should be included, showing the work covered by the Agreement and also draft details of the various elements of the works.

3.5.2. Recovery of Council's Costs

- (i) The Council incurs cost in carrying out various activities in the course of the adoption procedure which normally includes technical examination, processing the Section 38 submission, site inspections and material testing.

These costs will be recovered by charging a fee as follows:

ESTIMATED COST OF THE WORKS	FEE
up to £10,000	£1000
over £10,000	6% of estimated cost

The estimated cost of the works will be determined by the Council and is reviewed annually.

- (ii) Fees should be paid immediately before the first site inspection or on signing of the Section 38 Agreement whichever occurs first.
- (iii) Legal Fees may be charged in addition and recovered at cost or by a standard charge, calculated to be non-profit generating, payable on demand.
- (iv) Fees have been based upon the assumption that the design submission and the construction of the works are in general accordance with the recommendations set out in this Guide. In the event that the submission or that the construction of the works falls below these standards the Council reserves the right to recover additional costs incurred in the administration of the Agreement arising from the rechecking of drawings/calculations and site visits for rechecking sub-standard work. Additional charges may not be levied for additional costs relating to changes to the works arising from unforeseeable circumstances (e.g. adverse ground conditions) but if there is a significant increase in the estimated cost of the works then a proportional increase in the fee may be made.

3.6. NEW ROADS AND STREET WORKS ACTS

The legislation requires the highway authority to keep a street works gazetteer of all streets within the highway authority's area. The developer shall, therefore, supply to the highway authority such information as required to enable the authority to comply with the legislation and maintain the street works gazetteer.

The current requirements are:-

- The agreed name of the street.
- Status of street (prospectively maintainable or private).
- Owner of street if private.
- Elementary street unit for each street, together with immediate points to enable the creation of a level 3 gazetteer ([see http://www.nsg.org.uk/](http://www.nsg.org.uk/))

The information shall be provided within four weeks of the street being named or building work commencing whichever occurs first. Information presented shall be supported by an O.S. based plan preferably in a digital format.

Any changes during the construction phase which invalidate the information shall

be notified to the engineer within four weeks of the change and revised information submitted.

3.7. SUBMISSION REQUIREMENTS

3.7.1. General Information

- (i) 2 no. 1:1250 scale plans (1 copy to be a negative) of the proposed development (including building units) to include OS grid lines for reference (where practicable).
- (ii) 2 no. 1:500 scale plans with contours.
- (iii) 2 no 1:500 scale drawings, uncoloured, showing the roads, sewers and proposed developments (see section 3.6.2 for detailed requirements).
- (iv) Name and contact address and telephone number of the Developer and agent or other employee in charge of the works.
- (v) Anticipated date for commencement of the works and the dates for completion to Part 1 and the whole of the works.
- (vi) Programme for the construction of the works.

3.7.2. Detailed Requirements

- (i) The relationship of the proposed layout to the existing ground features and the Ordnance Survey grid (where practicable).
- (ii) Carriageways, footways, footpaths, cycletracks and verges showing widths of each.
- (iii) The location of buildings, plot boundaries and points of pedestrian and vehicular access to the plots.
- (iv) Drainage details including all road, cycletrack and footpath gully positions with connections to the appropriate sewers, including calculations for highway drainage where appropriate.
- (v) Crossfall to carriageways, footways, footpaths, cycletracks and verges.
- (vi) Sight lines at all junctions and all other relevant locations.
- (vii) All dimensions of radii and curves to be indicated.
- (viii) Centre line to chainages to a change of horizontal and/or vertical alignment.
- (ix) The location of proposed ramped footway and cycletrack crossings for pedestrians, cyclists and invalid carriages.
- (x) Emergency means of access (where required).

- (xi) Residential and visitor parking to be indicated.
- (xii) A plan showing all service runs (if available).
- (xiii) All street furniture e.g., street lighting, nameplates etc.
- (xiv) All areas for proposed adoption by the Highway Authority (ensuring connection of proposed roads to existing or potentially adoptable highway).
- (xv) Traffic calming proposals (where required).
- (xvi) The locations of salt bins (where required).

3.7.3. DRAWING SUBMISSIONS

- (i) 8 no. drawings to 1:500 scale, with OS grid lines, (where practicable) coloured to show those works to be covered by the Agreement.

Colouring to be as follows:-

Boundary of the development	-	Blue
Carriageway	-	Burnt Sienna
Footways and footpaths	-	Yellow

Note: Where footpaths cross areas of public open space they are to be coloured yellow and hatched purple.

Cycletracks	-	Orange
-------------	---	--------

Note: Where alteration of an Existing path/track occurs to form a cycletrack, they are to be coloured orange and hatched purple.

Street lighting column positions	-	Red
Highway Verge	-	Green
Public Open Spaces	-	Pink
Highway drains and gully leads from surface water sewers	-	Blue

Works outside the site boundary carried out as part of the development are to be bounded by a mauve line.

- (ii) 4 no. drawings of longitudinal sections of roads.

Scales to be 1:500 horizontal and 1:50 vertical (depending on topography) and the drawing should show the following:

- (a) Existing ground levels.
 - (b) Proposed road centre line levels and channel levels.
 - (c) Extent of horizontal and vertical curves.
 - (d) Centre line chainages.
 - (e) Highway drainage details including levels, pipe sizes, gradients and manholes.
- (iii) 4 no. drawings of cross sections of 1 to 50 scale and showing the following:-
- (a) The profile within the highway boundaries.
 - (b) The construction of carriageways, footways, cycletracks, footpaths, verges and hardstandings giving details of the finished thickness and types of material to be used.
 - (b) Drainage details.
- (iv) 10 no. plans of the development with the areas of public open space within the development coloured only (where applicable).
- (v) Street lighting design to BS 5489 either in the form of isolux lines or spot light levels.
- (vi) 2 no. plans indicating layout of sewers subject to a Section 104 Agreement (where applicable see Clause 4.3).

3.7.4. Geotechnical Report

A geotechnical report incorporating CBR test results, soil classification (liquid and plastic limits) and identification of sulphate levels. (See Clause 10.1.1).

3.8. ISSUING OF CERTIFICATES

The Part 1, Part 2 and Part 3 Certificates are eligible to be issued by the Engineer upon the request of the Developer and on completion of the following:-

3.8.1. Part 1 Certificate

- (i) All highway drainage
- (ii) Where applicable all other drainage within the highway.
- (iii) All kerbs or channels required to retain the carriageway.
- (iv) Carriageway to basecourse.

NOTE: The Bond amount will be reduced to 60% upon completion of the above works.

3.8.2. Part 2 Certificate

- (i) All kerbs, channels, vehicle crossings and pedestrian ramps.
- (ii) The provision of street lighting with electricity supply.

NOTE: At this stage, or prior to with the agreement of the Engineer, upon submission of the ET1 and ET2 forms and the completion of any remedial works, the Council will accept the energy charges and carry out general routine maintenance works to the street lighting.

- (iii) Footway/footpath/cycletrack binder course.
- (iv) Temporary street nameplates.
- (v) Demarcation of sight lines and visibility splays.

NOTE: The bond amount will be reduced to 40% upon completion of the above works.

3.8.3. Part 3 Certificate

- (i) Any outstanding kerb and channel work.
- (ii) Carriageway surface course (see note c below)
- (iii) Footway, footpaths, cycletrack surface course.
- (iv) Verges and visibility splays.
- (v) Street furniture.
- (vi) Street nameplates.
- (vii) Road markings and signs.
- (viii) All other work required by the specification and shown on the drawings.
- (ix) Information required by Section 79 and 80 of the New Road and Streetworks Act 1991 must have been provided. (See Clause 4.2 (ii))
- (x) An as built drawing to be provided. The drawing is to record the positions of all street furniture (Light Columns (with numbers), Street name plates, bollards, gullies). These drawings to be sent electronically in a .dxf format. If this can not be achieved a commuted sum will be required to enable the Authority to carry out the work in house.

NOTE: (a) The works must connect with other existing adopted highways.

- (b) The sewers must have been previously placed on maintenance in accordance with Section 104 of the Water Industry Act 1991.
- (c) The Developer is responsible for carrying out a CCTV survey and undertaking any remedial works (to the satisfaction of the Engineer) prior to the surface course being laid including all house connections within the highway limits (see Clause 4.3).
- (d) The Bond will be reduced to 10% of the original amount upon completion of the above works.

3.9. MAINTENANCE PERIOD

The issue of a Part 3 Certificate will instigate commencement of a 12 month maintenance period.

It should be noted that the Developer will be responsible for all maintenance aspects relating to the adoptable works during this maintenance period and until adoption.

Typically maintenance activities could be anticipated in respect of the following:-

- (a) road and footpath cleaning
- (b) street lighting (lamp faults)
- (c) drainage (gully cleaning)
- (d) landscaping (grass cutting, shrub pruning, weed removal).

It is the Developers responsibility to request the attendance of the Engineer for the Final Inspection on completion of the maintenance period.

The Final Inspection should be a joint inspection and the Engineer will require the following items to have been satisfactorily addressed prior to adopting.

- (a) S104 sewer adoption (see Section 4)
- (b) The completed Health and Safety file including as constructed plans (services etc) (see Section 4)
- (c) Street lighting certificates (see Section 11)
- (d) CCTV of highway drainage (see Section 12)

In addition, any defects or outstanding work items must be resolved to the Engineers satisfaction prior to adoption.

3.10. ADOPTION PROCEDURE

Following satisfactory completion of the Maintenance Period and issue of the Final Certificate, the Engineer will process the adoption.

The Developer will be advised in writing of the effective date of adoption and outstanding Bond monies will be released.

CONTENTS

<i>CLAUSE</i>	<i>TITLE</i>	<i>PAGE</i>
4.1	<u>CONSTRUCTION (DESIGN AND MANAGEMENT) REGULATIONS 1994</u>	16
4.2	<u>NEW ROADS AND STREET WORKS ACT 1991</u>	16
4.3	<u>SECTION 104 WATER INDUSTRY ACT 1991</u>	16
4.4	<u>UTILITY APPARATUS IN THE HIGHWAY</u>	17
4.5	<u>DISCHARGE OF HIGHWAY DRAINAGE INTO EXISTING WATERCOURSES</u>	17
4.6	<u>DEPOSITS ON THE HIGHWAY</u>	18
4.7	<u>DIVERSION OF HIGHWAYS OR PUBLIC RIGHTS OF WAY</u>	18
4.8	<u>UNAUTHORISED SIGNS ON THE HIGHWAY</u>	18
4.9	<u>HIGHWAY STRUCTURES</u>	18

4.**4.1 CONSTRUCTION (DESIGN AND MANAGEMENT) REGULATIONS 1994**

The Developer will be required to carry out the works in compliance with all relevant Health and Safety Legislation, including the Construction (Design and Management) Regulations 1994. The Developer is responsible for the preparation of the Health and Safety File for the project and upon completion of the maintenance period, those aspects relevant to the highway must be passed on to the Highway Authority.

4.2 NEW ROADS AND STREET WORKS ACT 1991

- (i)* The Developer should note that when it is necessary to make any connection or break into any highway outside the site boundary, then the requirements of the New Roads and Streetworks Act 1991 will apply. A licence will have to be obtained from the Borough Council and the prescribed fee paid. This licence and inspection fee is not covered within the payments made under the Section 38 Agreement.
- (ii)* The Developer should note that it is a requirement of Section 79 and 80 of the New Roads and Streetworks Act 1991 that the precise location and depth of all services including drainage and gully connections are accurately recorded. This information must be submitted to the relevant authority before the Part 2 certificate (Section 38 Agreement) will be issued.

4.3 SECTION 104 WATER INDUSTRY ACT 1991

Where applicable the Developer will be required to enter into a formal agreement with the Undertaker (Water Industry) in respect to sewers and pumping stations (in accordance with Section 104 Water Industry Act 1991).

Clearly, the laying of sewers within the highway limits is of interest to the Highway Authority, not least of all for the connection of highway drainage. It is essential that special care is taken to ensure that sewer trenches are correctly backfilled.

Therefore, the Highway Authority requires that the following items must be complied with.

- (i)* The Section 38 Agreement will only be signed on certification from the Water Authority that the Section 104 Agreement has been signed (where applicable).
- (ii)* The 12 month maintenance period for highway works (Part 2 Certificate) will only commence on confirmation that the sewers have been placed on maintenance in accordance with Section 104 (where applicable).

- (iii) The final certificate and subsequent adoption will only occur on conformation that the sewers have been adopted by the Water Authority.
- (iv) Sewer excavations are backfilled in accordance with Clause 10.10
- (iv) It is the Developers responsibility to ensure notification of Section 104 approvals etc. to the Engineer.

It should be further noted that it is a requirement of the Highway Authority that the Developer carries out a CCTV survey of all sewers within the highway, prior to carriageway surface courses being laid. The purpose of this requirement is to ensure the adequacy of the sewer system and avoid the need for opening of the highway for remedial works. This requirement is in addition to the CCTV survey, which will be organised by the Water Authority, prior to adoption of the sewer systems.

If timed correctly, a single survey could be used to meet both the Highway Authority and Water Authority requirements, although this must include all highway drainage and private connections in the Highway.

4.4 UTILITY APPARATUS IN THE HIGHWAY

The Developer will be responsible for ensuring that all utility apparatus required as part of the development is properly installed prior to the commencement of the maintenance period. This will involve any apparatus that would normally be provided by the utility companies for such a development, including cable television etc.

Utility apparatus in areas proposed for adoption by the Highway Authority shall only be installed on behalf of either Statutory Undertakers or companies appropriately licensed by the Department of Transport, Local Government and the Regions, thereby having the same duties and responsibilities as Statutory Undertakers. The developer is also required to provide the Highway Authority with a comprehensive list of names and addresses of all those companies the developer intends to use to install such apparatus, the list to include the SWA Organisational Reference number. This information **MUST** be provided before a Part 2 certificate will be issued. Failure to provide such information may result in the Highway Authority making a declaration under section 87 of the NRSWA 1991.

Utility apparatus proposed for adoption by other bodies or to be retained in the ownership of the developer or developers Contractor will not normally be granted authorisation by the Highway Authority. The only exception to this is the short lengths which provide a connection from the Statutory Undertakers Equipment in the abutting highway and which are normally nominally at right angles to the S.U. Equipment (e.g. sewer connections), where the relevant Statutory Undertaker would normally require these to be the responsibility of adjacent property owners.

4.5 DISCHARGE OF HIGHWAY DRAINAGE INTO EXISTING WATERCOURSES

All highway drains shall be constructed within the limits of the highway. There is normally only one exception to this, namely where there is a need for the highway

drainage to discharge into an existing watercourse outside the highway boundary. In such circumstances, permission must first be obtained from the Environment Agency prior to any discharge taking place. In addition, a “Deed of Grant of Easement” will be required from all landowners through whose land the drainage passes to the watercourse.

The Developer is responsible for obtaining all of the necessary permissions and consents, prior to signing the Section 38 Agreement.

4.6 DEPOSITS ON THE HIGHWAY

The Developer is responsible for ensuring that all roads, footpaths etc are kept clean and free from dust, mud slurry and any obstruction. Failure to do this is not only creating a safety hazard for highway users but would also be an offence under Section 148 of the Highways Act 1980. Developers should note that both the Highway Authority and the Police view such an offence as a serious matter and this could well lead to prosecution.

4.7 DIVERSION OF HIGHWAYS OR PUBLIC RIGHTS OF WAY

Where the diversion of any existing carriageway, footway, footpath, cycleway or public right of way is required due to the development works, the Developer shall consult with the Engineer at any early stage to ensure that all necessary legal procedures for any diversion are implemented.

4.8 UNAUTHORISED SIGNS ON THE HIGHWAY

Unauthorised signs of any description, including routing directions for site traffic and advertising signs, shall not be erected on the public highways. These illegal signs will be removed by the Highway Authority and the Developer recharged with all costs incurred.

4.9 HIGHWAY STRUCTURES

Any proposal that requires the construction of a highway structure (i.e., a retaining wall or bridge) will require a ‘Technical Approval’, by the Highway Authority, of the structure regardless of who will be responsible for its future maintenance.

In this respect a document has been produced ‘Technical Approval Procedure for Developers Structures’ and is available free of charge to developers from the address at the front of this document.

This procedure should be applied to the designs of all structures with a clear span or internal diameter greater than 0.9m, retaining walls, within 1.5h (where h is the retained height of the wall) or 4m of the carriageway, or public footpath, supporting land above the highway. All retaining walls supporting the highway, or public footpath, itself and to temporary structures under, over or adjacent to a road carrying public traffic.

This procedure should be applied to proposed structures to which Sections 167 and

176 to 180 inclusive of the Highways Act 1980 are relevant and, where directed by the Highway Authority to any proposed structure, under, in, adjacent or near to an existing or proposed highway maintainable at public expense or any other structure providing access for the public. Such latter structures shall include any tunnels, service culverts, thrust bores, chambers, manholes and the like proposed by statutory undertakers and other bodies, also to the assessment of load carrying capacity and whole life cost, alterations, strengthening and repairs of existing structures to be adopted.

In the case of any doubt, the Highway Authority will decide whether a structure requires the procedure to be followed.

The Technical Approval Procedures shall be completed before any work commences on site. A minimum period of 3 months should be allowed between final submission and approval.

The Highway Authority will make a charge to cover its costs in administering the Technical Approval Procedure preparing Licences or Agreement required by the Highways Act and its inspection costs. This charge which will vary according to the complexity of the design, will be based upon the actual cost incurred and shall be additional to and independent of the fees chargeable in connection with the Section 38 Agreement.

Any materials testing carried out by the Engineer will be charged separately in addition to the fees.

A commuted sum will be required to cover the Highway Authority's additional future costs in maintaining any structure subject to this Technical Approval Procedure where it is to be adopted.

All fees due are to be paid to the Highway Authority by the times which it may stipulate.

CONTENTS

<i>CLAUSE</i>	<i>TITLE</i>	<i>PAGE</i>
5.1	<u>HIERARCHY OF ROADS</u>	21
5.2	<u>CARRIAGEWAYS – GEOMETRY AND CONSTRUCTION STANDARDS</u>	23
5.3	<u>SHARED SURFACES</u>	38
5.4	<u>FOOTWAYS AND FOOTPATHS – GEOMETRY AND CONSTRUCTION STANDARDS</u>	44
5.5	<u>PARKING STANDARDS</u>	48
5.6	<u>TRAFFIC CALMING</u>	48
5.7	<u>CYCLING FACILITIES</u>	48
5.8	<u>STREET LIGHTING</u>	48
5.9	<u>HIGHWAY DRAINAGE</u>	48
5.10	<u>HIGHWAY VERGES</u>	48
5.11	<u>STREET NAME PLATES</u>	48
5.12	<u>SIGNING AND ROAD MARKING</u>	48
5.13	<u>PUBLIC SAFETY</u>	49
5.14	<u>STATUTORY UNDERTAKERS APPARATUS</u>	49
5.15	<u>VEHICULAR SERVICING OF COMMERCIAL PREMISES</u>	49

5.0 RESIDENTIAL DEVELOPMENTS

5.1 HIERARCHY OF ROADS

5.1.1 Introduction

The relationship between distributor and residential roads in the urban road system is detailed in the following paragraphs and illustrated diagrammatically in Sketch 5.1.1

- 5.1.2 Primary Distributor roads form the primary network within which all longer distance traffic movements are channelled.
- 5.1.3 District Distributor roads distribute traffic between the residential districts of the town and form the link between the primary road network and the road network within the residential areas.
- 5.1.4 Local Distributor roads (category 1) are 'through' roads forming a link between district distributor and access roads which distribute traffic within the residential districts. These roads provide vehicular access to more than 500 dwellings and should not give direct vehicular access to dwellings.
- 5.1.5 Primary Access roads (category 2) are 'through' roads and are similar to local distributor roads but only provide vehicular access to between 301 and 500 dwellings and should not give direct vehicular access to dwellings.
- 5.1.6 Secondary Access roads (category 3) are normally 'through' roads and link dwellings, their associated parking areas and open spaces to either primary access or local distributor roads. These roads provide vehicular access to between 101 and 300 dwellings.
- 5.1.7 Residential roads (category 4) must not attract through traffic and would normally be cul-de-sac. These roads provide vehicular access up to 100 dwellings.
- 5.1.8 Shared Surface roads (category 5) provide vehicular access to no more than 15 dwellings and must not attract through traffic. These roads are distinctive by virtue of the absence of footways and thus the road surface is jointly used by pedestrian and vehicular traffic.

It is recognised that in rural areas and some urban infill sites, it may be difficult or inappropriate to achieve the requirements specified in the aforementioned hierarchy. It is recommended in such cases that consultation with the Engineer takes place at an early stage.

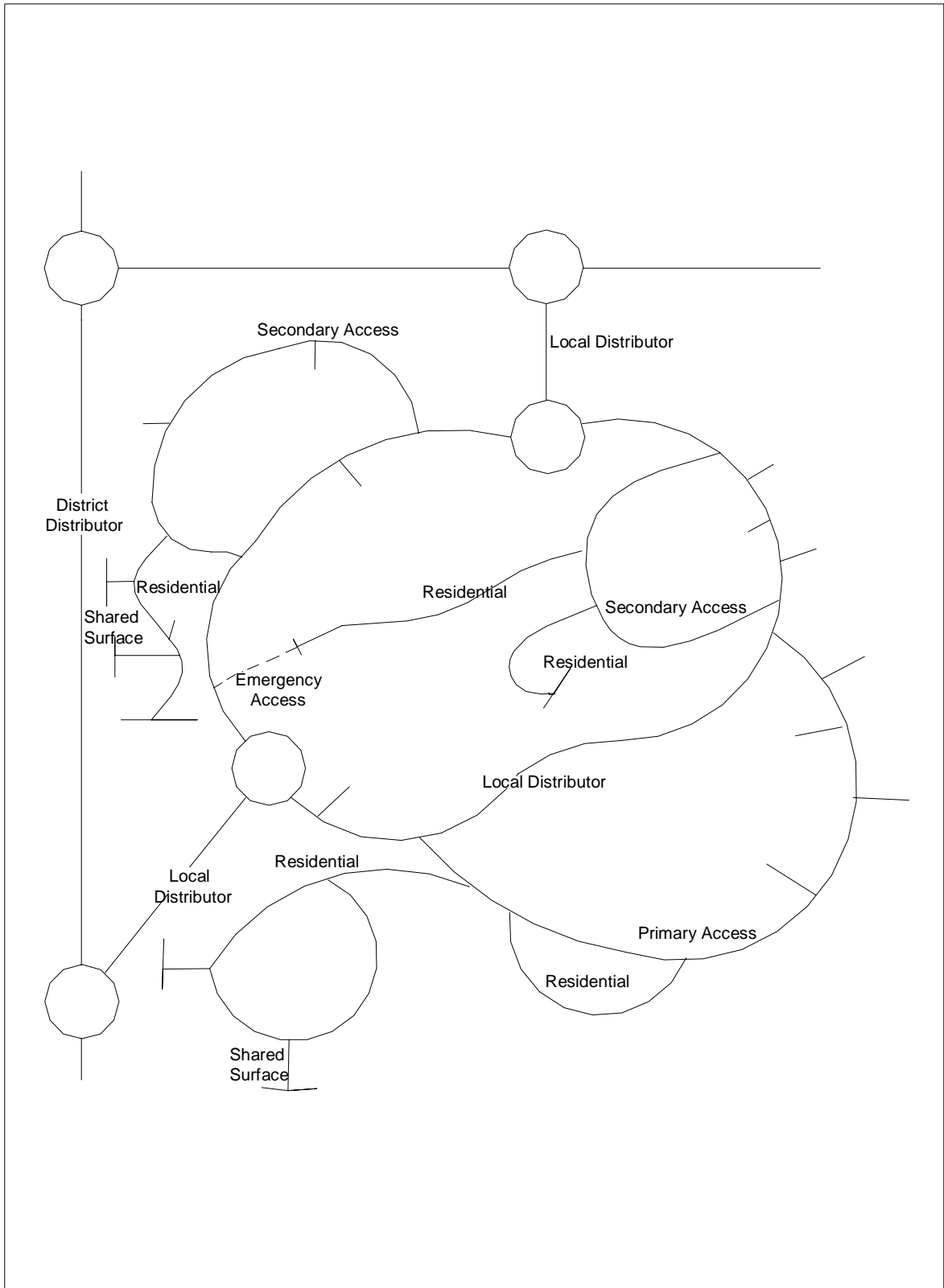

CONTENTS

<i>CLAUSE</i>	<i>TITLE</i>	<i>PAGE</i>
5.2.1	<u>INTRODUCTION</u>	24
5.2.2	<u>JUNCTIONS</u>	24
5.2.3	<u>ROUNDABOUTS</u>	25
5.2.4	<u>CARRIAGEWAY WIDTH</u>	25
5.2.5	<u>DESIGN SPEEDS</u>	25
5.2.6	<u>VISIBILITY REQUIREMENTS</u>	25
5.2.7	<u>CROSSFALLS AND GRADIENTS</u>	29
5.2.8	<u>VERTICAL CURVES</u>	29
5.2.9	<u>HORIZONTAL CURVES</u>	29
5.2.10	<u>VEHICLE TURNING FACILITIES</u>	29
5.2.11	<u>VEHICULAR ACCESS TO PROPERTIES</u>	29
5.2.12	<u>EMERGENCY ACCESS</u>	30
5.2.13	<u>SITE INVESTIGATION REPORT</u>	30
5.2.14	<u>CARRIAGEWAY CONSTRUCTION</u>	30
5.2.15	<u>EMBANKMENTS AND CUTTINGS</u>	31
5.2.16	<u>CHANNELS</u>	32
5.2.17	<u>VERGES</u>	32

5.2 CARRIAGEWAYS – GEOMETRY AND CONSTRUCTION STANDARDS

5.2.1 Introduction

The following standards apply to local distributor roads, and categories below this, since higher road categories are seldom the concern of a private developer. Therefore, the standards relate to the types of carriageway required at the local (district) level.

For the design of higher categories the advice of the Highway Authority should be sought at an early stage.

Appendix 5.2 provides a detailed summary of the design standards associated with Category 1 to 5 roads.

The Engineer must be consulted at the initial layout stage to consider the likelihood of bus services penetrating the development and to indicate possible routes. Bus lay-bys should be in accordance with Sketch 5.2.2. Low floor bus kerbs are to be used, following consultation with the relevant Engineer, at all bus stops

5.2.2 Junctions

Junctions shall be positioned in accordance with the standards shown in Sketch 5.2.1. The design of new junctions with the Primary and District Distributor network shall be determined by the Engineer.

Junctions of any roads with a local distributor road (Category 1) and primary access road (Category 2) should be a desirable minimum distance of 90m and 60m apart respectively, where roads are located on one side of the major road.

For Category 1 and 2 roads where junctions are formed by any roads emerging onto alternate sides of that road, the junctions stagger shall be not less than 40m and 30m respectively. Where a cross movement is expected a right to left stagger is to be preferred.

For Categories 3 and 4 roads, junctions shall be located at not less than 40m and 30m spacing respectively where roads are located on one side of the major road. Where junctions emerge from alternate sides the minimum spacing varies from 20m to 15m.

All junctions should be of the ‘T’ type with the angle as close to 90 as possible.

At a junction where the minor road is a category 1 or 2 road, 12m radii shall be used. At all other junctions 6m radii should be used.

All road junction gradients shall be a maximum of 5% over the extent of the bellmouth.

5.2.3 Roundabouts

Should the Developer propose to include a roundabout on the road layout, consultation should take place with the Engineer at an early stage. The design is required to comply with DTp notes for guidance TD16/93 and TA23/81.

In addition, it will be a requirement to include chevron block paving to the perimeter of a roundabout of 4m dia or larger.

5.2.4 Carriageway Width

The carriageway width shall be in accordance with the standards shown in Appendix 5.2. However, early consultation is recommended with the Engineer as a higher standard may be necessary to cater for future development.

When a road may become a bus route the carriageway shall be not less than 6.7m in width. In cases where the road may be of major importance (e.g., servicing shopping, business and community centres or future development) the Engineer may require a carriageway of 7.3m width.

5.2.5 Design Speeds

Design speeds shall be in accordance with the standards shown in Appendix 5.2.

5.2.6 Visibility Requirements

Achieving the standards of visibility throughout the road layout is considered to be an essential element of design.

Guidance in this case is provided directly from Design Bulletin 32 (Second Edition) paras 3.56 to 3.68 and is repeated in part below.

Any land falling within a visibility splay must be included in the Section 38 Agreement and become part of the adopted highway.

(i) Sight Lines

To enable drivers to see a potential hazard in time to slow down or stop comfortably before reaching it, it is necessary to consider the drivers line of vision, in both the vertical and horizontal planes, and the stopping distance of the vehicle.

The eye level of drivers can vary from 1.05m above the carriageway in a standard car to approximately 2m in commercial vehicles. To enable drivers to see each other across summits, across bends and at junctions, unobstructed visibility will be required at least between these heights above the carriageway.

However, for drivers to see and be seen by pedestrians, particularly child pedestrians and wheelchair users unobstructed visibility will be required to a point closer to the ground. The height of a very young child of walking age

is around 780mm, but the height of a child on a tricycle can be even lower. As general guidance, it is suggested that a height of 600mm be taken as the point above which unobstructed visibility should be provided wherever the potential exists for conflicts between motorists and young children. This will apply along most sections of residential roads and especially where shared surface roads are used.

The most obvious obstructions to visibility are summits, adjacent buildings (including bus shelters), screen walls, densely planted trees, and parked cars. Shrubs and trees may be planted in visibility splays at junctions and on bends, provided when mature they do not obscure horizontal sight lines and there will continue to be clear vision between heights of 600mm and 2m above ground level. Generally the aim should be to ensure good visibility without having to rely on frequent maintenance.

(ii) Stopping distances

The horizontal distance over which unobstructed visibility should be maintained will depend upon the stopping distance of vehicles as shown in Table 5.2.1. This in turn will depend upon vehicle speeds, deceleration rates and drivers reaction times. The distances are intended to cater for the majority of vehicles and drivers in most weather conditions and may therefore safely be used as guidance in the design of the residential road network.

TABLE 5.2.1

DESIGN SPEED		ROAD CATEGORY	MINIMUM STOPPING DISTANCE (m)
km/h	mph		
16	10	5	14
32	30	4a or 4b	33
40	25	3	45
48	30	2	70
60	40	1	90

(iii) At Junctions

To enable drivers emerging from the non-priority road to see and be seen by drivers proceeding along the priority road unobstructed visibility is needed within the shaded areas indicated in Figure 5.2.1.

FIGURE 5.2.1

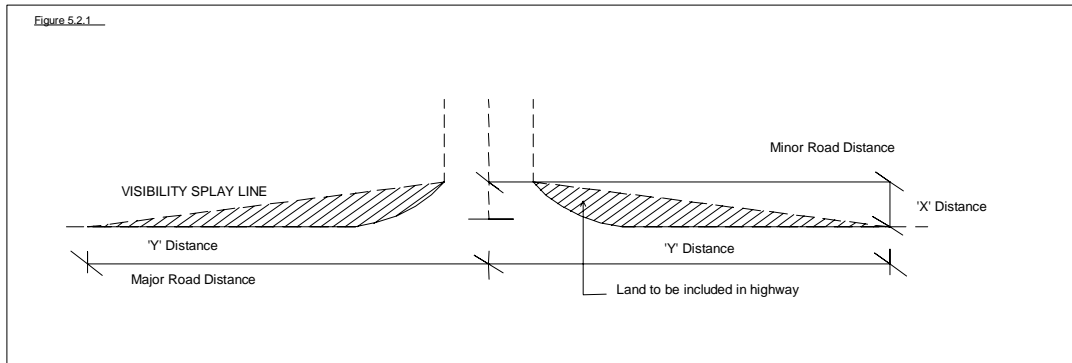

Where:

- X is a line measured along the centre line of a side road from the nearside kerbline of the major road.
- Y is a line measured in both directions along the nearside kerbline of the major road from the intersection of the kerbline and the centre line of the side road.

The X and Y dimensions are as detailed in Appendix 5.2.

Note: Where the road junction occurs on a road incorporating a bend, it is essential to note that the visibility envelope must incorporate the full road width, irrespective of the end point of the 'y' dimension.

Where traffic flows are low and where the need to avoid delay has low priority, the Y dimension may be based on the expected speed of the vehicle on the priority road and hence on the stopping distance required for it to slow down or stop in order to avoid collision with vehicles emerging from the non-priority road.

Where the priority road is heavily trafficked such as on a local distributor road the objective will usually be to avoid the need for through traffic to change course, slow down or stop. In order to achieve this, drivers emerging from the non-priority road must be able to see far enough along the priority road to be able to judge when to emerge without interrupting through traffic movement.

(iv) At Driveways

Where a driveway meets the back edge of a footway a visibility splay with X and Y dimensions of 2.4m should be provided with clear visibility between 0.6m and 2.0m above the footway (see figure 114 DB 32).

Where a driveway meets a carriageway or a shared surface an X dimension of 2.4m should be provided, though in urban areas with a speed limit of 30 mph or less this distance may be reduced to 2m with a Y dimension in accordance with Appendix 5.2 (see figure 115 DB 32).

(v) On Bends

Forward visibility curves on bends should be constructed in accordance with the procedure set out below and as indicated in Figure 5.2.2.

- (a) a line should be drawn parallel to the inside kerb, 1.5m into the carriageway to represent the path of the vehicle.
- (b) the required stopping distance commensurate with the expected speed of the vehicle should be ascertained and measured back along the vehicle path from tangent point A;
- (c) the stopping distance should then be divided into equal increments of approximately 3m, and the increment points numbered in sequence;
- (d) the same stopping distance with the same number of increments should then be repeated around the curve, finishing at a full stopping distance beyond the tangent point B;
- (e) the area which has to be kept clear of obstruction should then be constructed by joining increments of the same number together i.e., 1 to 1, 2 to 2 etc.

FIGURE 5.2.2

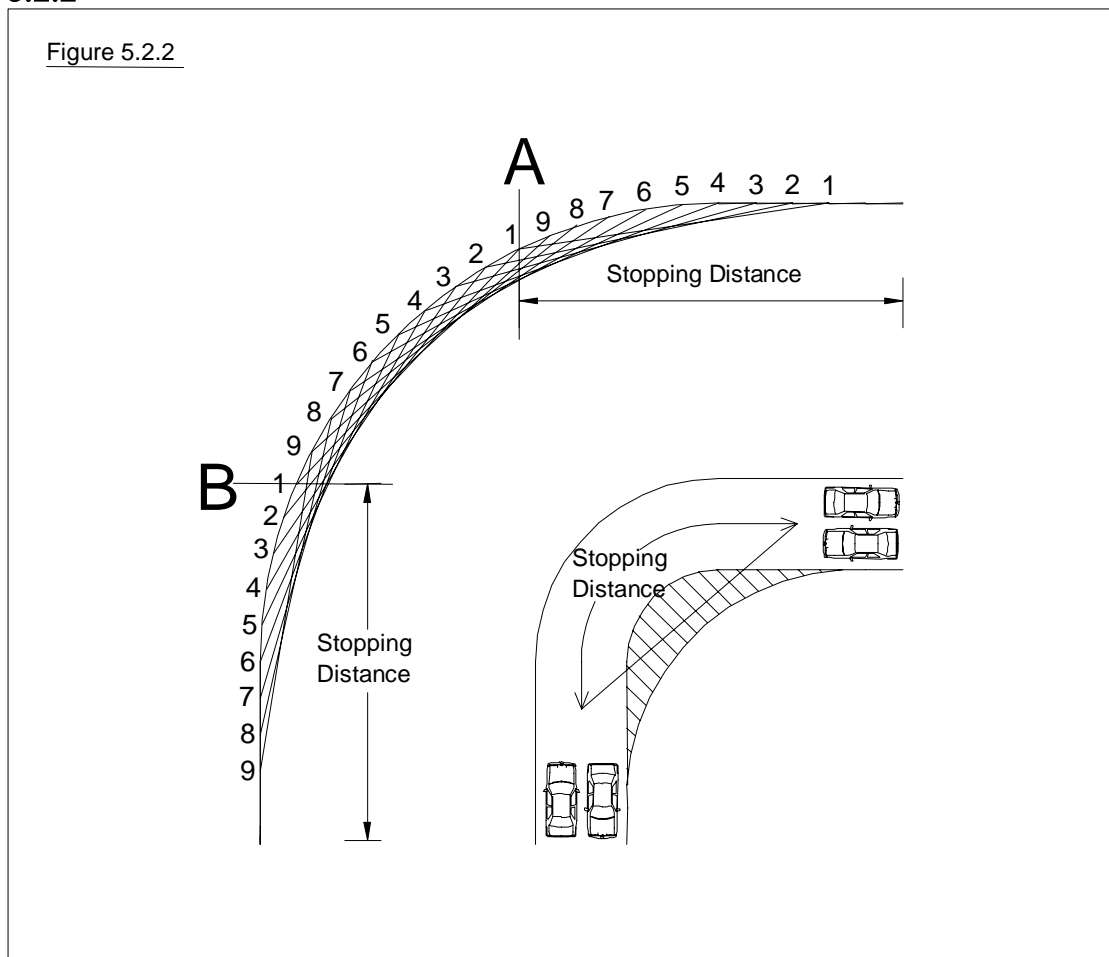

5.2.7 Crossfalls and Gradients

Normally a carriageway longitudinal gradient of 5.0% (1 in 20) should be taken as the maximum and 0.8% (1 in 125) as the minimum. (Minimum gradient on block paved roads is 1:80, in accordance with BS 6717 Pt 3). If site conditions dictate a steeper gradient, and this variation is approved by the Engineer, then surfacing materials giving a higher skid resistance will be required (see Clause 10.7.2). Normally a road should be designed with a 2.5% (1 in 40) camber. A crossfall of 2.5% (1 in 40) should be used around bends with super elevation applied in accordance with the criteria set out in Appendix 5.2. Cambers and crossfalls should not exceed 5%. The carriageway levels should be designed to ensure a maximum gradient of 8% (1 in 12) for in curtilage driveways.

Note: Where the longitudinal gradient of a road exceeds 1:20 at a junction the Engineer may require the provision of salt bins. These bins must be in place for the Winter Maintenance season (October to April), in a location to be agreed with the Engineer, and be maintained and regularly filled by the Developer during this period up until the adoption of the highway.

5.2.8 Vertical Curves

Vertical curves shall be provided at all changes in gradient and be designed so that the safe stopping distance given in Appendix 5.2 is provided. This distance is measured along the centre line of both traffic lanes between points 1.05m above the road in the case of Category 1 and 2 roads and 1.05m and 0.6m in both directions in the case of Road Categories 3, 4 and 5 roads.

5.2.9 Horizontal Curves

Horizontal curves shall be designed in accordance with Appendix 5.2 which gives the minimum centre line radii of the carriageway together with any super elevation requirement.

However, for 4.8m roads with centre line radii of 20m and less, there must be widening to 5.5m at any change of direction greater than 30°.

5.2.10 Vehicle Turning Facilities

Turning facilities shall be designed in accordance with Sketch no 5.2.3. These standards have been determined for the use of a refuse vehicle. An extension of a cul-de-sac may be permitted beyond a side turning bay or leg of a hammerhead provided the length of the extension does not extend 14m beyond the tangent point. This extension is subject to full parking facilities being provided within the curtilage of adjacent dwellings.

If the length of a cul-de-sac exceeds 180m then an additional side turning bay should be provided.

5.2.11 Vehicular Access to Property

The following standards shall apply:-

- (i) A limit of one access per property wherever possible, but where a double garage/vehicle hardstanding is provided the vehicle crossing must be widened accordingly. The access width shall be a minimum of 2.5m wide and a maximum of 5m.
- (ii) The access should be at 90° to the centre line of the road.
- (iii) In the interest of safety vehicular access to a plot is not to be situated on the radii of a junction.
- (iv) No more than 5 properties may be served from an adopted highway by means of a single private access which must not be longer than 25m and must be a minimum of 4.1m wide.
- (v) Any street lighting erected in a private access will be the responsibility of the house owners with regards to maintenance and energy changes.

Note: The Developer must ensure that the minimum distance from the public highway to the point of refuse collection does not exceed 25 metres.

5.2.12 Emergency Access

An emergency access (a secondary alternative route), which must be adopted, shall be provided where a cul-de-sac system serves a group of dwellings exceeding 50 in number and shall link between adopted highways.

5.2.13 Site Investigation Report

The Developer shall supply to the Engineer a site investigation report prepared by a Laboratory (with appropriate UKAS accreditation) which must include the sulphate Content of groundwater and the subsoil and soil classifications.

5.2.14 Carriageway Construction

The carriageway constructions shall be in accordance with the following notes and Table 5.2.2.

- (i) generally be of a flexible construction designed in accordance with the principles of Road Note 29 (TRL).
- (ii) where the number of commercial vehicles per day (cvd) is likely to exceed 175 in both directions the carriageway should be designed in accordance with DTp Vol 7 Design Manual for Roads and Bridges in consultation with the Engineer.
- (iii) be a minimum thickness of 450mm and constructed such that all materials within 450mm of the finished surface are non frost susceptible.
- (iv) achieve a design life of 40 years.

TABLE 5.2.2

CARRIAGEWAY LAYER	MATERIAL	ROAD CATEGORY 1 & 2 THICKNESS (MM)	ROAD CATEGORY 3, 4 & 5 THICKNESS (MM)
CAPPING CBR VALUES >5% >2% - 5% <2% - 2% See Clause 10.3.2	Imported Granular Fill	Nil 275 525	Nil 275 525
SUB BASE See Clause 10.3.3	Type 1	250	280
BASE (Road Base) See Clause 10.7.1	Rolled Asphalt Dense Macadam	100 120	70 90
BINDER COURSE See Clause 10.7.1	Rolled Asphalt Dense Macadam	60 60	60 60
SURFACE COURSE See Clause 10.7.1	Rolled Asphalt Dense Macadam	40 N/A	40 30

- Notes:** (a) The sub-base thickness is to be increased to give a minimum total construction depth of 450mm.
- (b) In areas where a capping layer has been used a minimum CBR value of 15% is to be achieved.
- (c) For CBR values of less than 2% the design proposals are to be submitted to the Engineer for approval.
- (d) Block paving in shared surfaces (Category 5 roads) replaces the surface course only.

5.2.15 Embankments and Cuttings

Should the Developer propose to construct any embankment or cutting above 2.5m in height or depth, or with side slopes steeper than 1 in 3 then reference must be made to the Dtp VOL 4 Design Manual for Roads and Bridges. All designs are to be submitted to the Engineer for approval prior to any work commencing on site.

5.2.16 Channels

Channels shall be utilised in the construction of all roads except Category 1 unless directed otherwise by the Engineer. Channels shall not be laid across road junction or side turning bays (see Clause 10.4.5).

5.2.17 Verge

A verge situated between the footway and carriageway shall not be less than 1.5m wide and must be provided on all local distributor roads. Such verges may be constructed using an approved form of hard surfacing (1.5m is regarded as the minimum width at which it is practical to maintain a grass verge).

APPENDIX 5.2 HIGHWAY DESIGN STANDARDS FOR RESIDENTIAL DEVELOPMENT

Road Category	Number of Dwellings Served	Carriageway Width (metres)	Minimum Constricted Carriageway Width (metres)	Minimum Width of Footways (metres)	Design Speed (Km/h)	Desirable Stopping Distance (metres)	Minimum Centre Line Radius on Bends (metres)	Junction (metres)					Visibility Height (metres)	Maximum Road Gradient	Super Elevation
								Desirable Minimum Spacing		Kerb Radii	Visibility Splay (see Note 5)				
								Adjacent	Opposite		X	Y			
Local Distributors Category 1 See note 1	500+	7.3	N/A	1.8	60 ⁷	90	127	90	40	12/6 ⁸	9	90	1.05	5%	5% (Max)
Primary Accesses Category 2 See note 1	301-500	6.7	N/A	1.8	48	70	60	60	30	12/6 ⁸	910	70	1.05	5%	5% (Max)
Secondary Accesses Category 3 See note 1	101-300	5.5	N/A	1.8	40	45 ¹²	30	40	20	6	4.5	4512	1.05-0.60	5% ¹¹	Remove Adverse Camber
Residential Category 4(a) Category 4(b) See note 4	51-100 1-50	5.5 4.8	N/A 4.16	1.8 1.8	32 32	33 33	30 10	30 30	15 15	69 69	4.5 3	33 33	1.05-0.60 1.05-0.60	5% ¹¹ 5% ¹¹	Remove Adverse Camber
Shared Surface Category 5	Up to 15	4.8	4.1	N/A	16	14	10	N/A	N/A	69	2.4	14	1.05-0.60	5% ¹¹	N/A

Notes related to Appendix 5.2.

- 1 Local Distributor road – there shall be no frontage access, except in exceptional circumstances, and traffic calming is only permitted if the speed limit is less than or equal to 48 kph (30 m.p.h).
- 2 Primary Access road – only in exceptional circumstances will frontage access be approved.
- 3 Secondary Access road – shall not attract through traffic and should not normally be a cul-de-sac.
- 4 Residential road – shall not attract through traffic.

Road Category 4(b) shall be widened to 5.5 metres on any bend of 20 metres radius or less and subject to a change of direction greater than 30°.

Emergency access shall be provided for cul-de-sac development in excess of 50 dwellings.

- 5 Visibility Splay – the requirement to be applied at any road junction shall be that of the higher category road that is being connected to (for example a Category 2 road joining a Category 1 road the visibility splay shall to be 9 x 90m.)
- 6 Constricted widths may only be applied over a maximum length of 15 metres.
- 7 If circumstances dictate the design speed may be reduced to 48 kph (30 mph) at the discretion of the Engineer.
- 8 Kerb radii of 12 metres are only required between junctions of Category 1 and Category 2 roads.
- 9 Kerb radii for cars may be reduced by introducing overrun areas in accordance with Sketch 8.3.5.
- 10 In exceptional circumstances, subject to approval by the Engineer, the X dimension on the visibility splay for Primary Access Roads may be reduced from 9 metres.
- 11 Refer to Clause 5.2.7.
- 12 If the road is designed with traffic calming or other speed reduction measures, which will realistically be able to deliver an average speed of 32 kph (20 mph) both the stopping distance and the 'y' dimension on the visibility splay may be reduced to 33m subject to the approval of the Engineer.

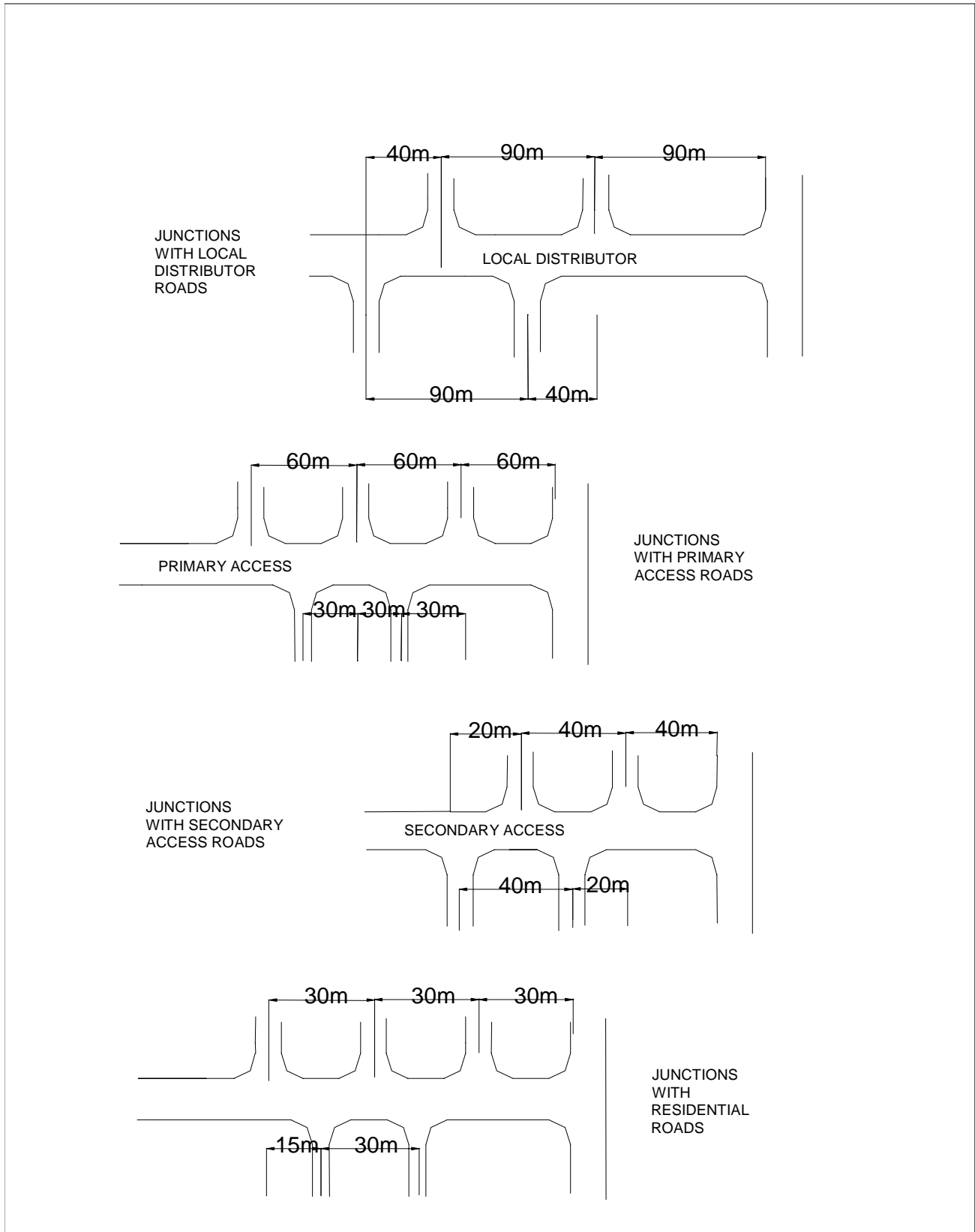

JUNCTION SPACING

Sketch No. 5.2.1

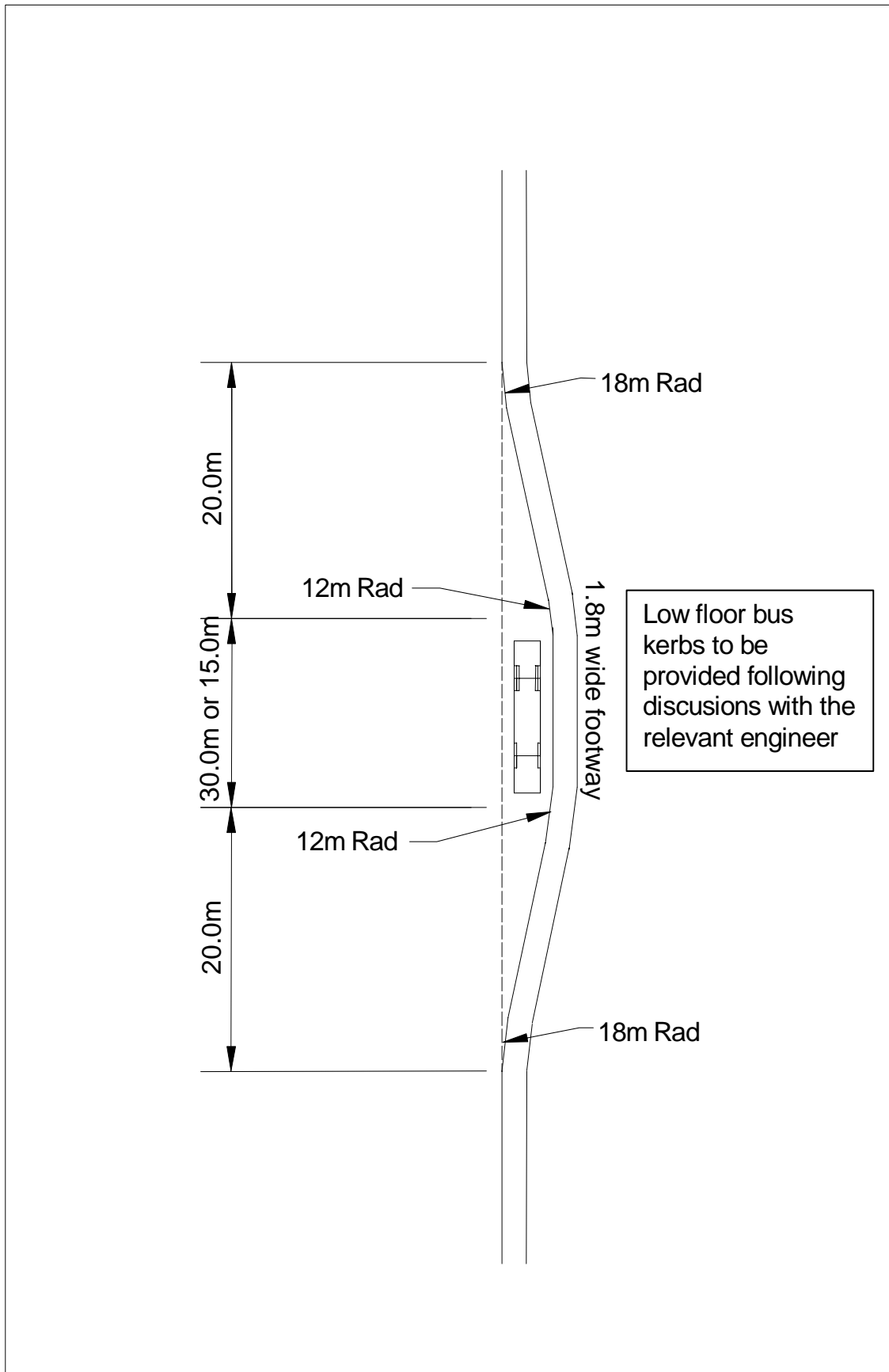

LAYOUT OF A BUS LAY-BY

Sketch No. 5.2.2

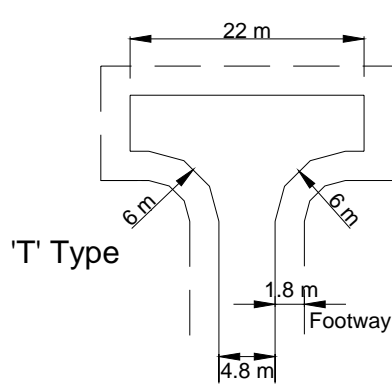

'T' Type

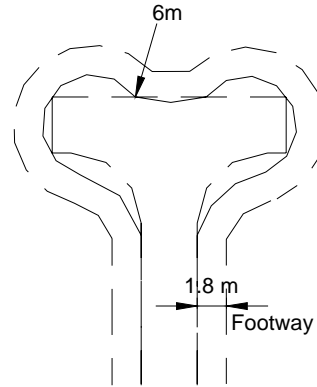

Minimum Kerb Radius to amorphous shapes 4.5m except where otherwise indicated.

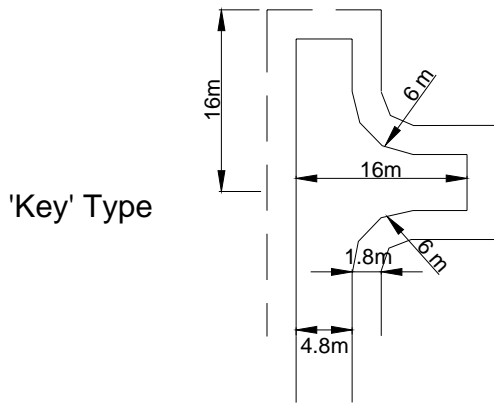

'Key' Type

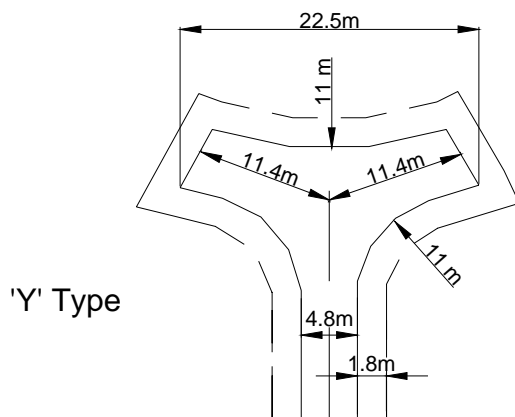
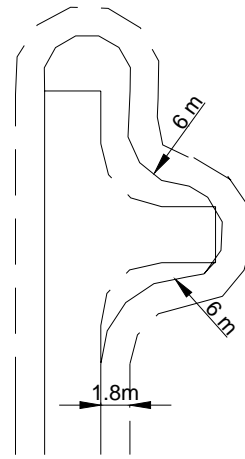

'Y' Type

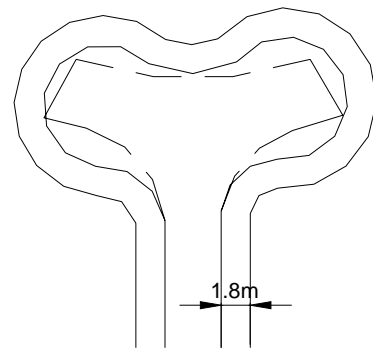

CONTENTS

<i>CLAUSE</i>	<i>TITLE</i>	<i>PAGE</i>
5.3.1	<u>DEFINITION OF A SHARED SURFACE</u>	39
5.3.2	<u>MAXIMUM NUMBER OF DWELLINGS</u>	39
5.3.3	<u>LENGTH OF SHARED SURFACE</u>	39
5.3.4	<u>CONSTRUCTION OF CARRIAGEWAY</u>	39
5.3.5	<u>ENTRY TO SHARED SURFACE</u>	39
5.3.6	<u>TURNING FACILITIES</u>	39
5.3.7	<u>KERBS</u>	40
5.3.8	<u>VERGES</u>	40
5.3.9	<u>SURFACE TO VEHICULAR CROSSINGS</u>	40
5.3.10	<u>SKETCHES</u>	40

5.3 SHARED SURFACES

5.3.1 Definition of a Shared Surface

Shared surface roads (Category 5) are jointly used by pedestrians, cyclists and vehicles. These areas shall not be considered as providing play or parking facility within the area to be adopted, including the 1.8m service strip.

Shared surfaces shall only be provided off a category 4 road or other suitably traffic calmed road.

5.3.2 Maximum Number of Dwellings

The maximum number of dwellings in a shared surface arrangement should not normally exceed 15.

5.3.3 Length of Shared Surface

The maximum length of any shared surface should not exceed 100m with a minimum length of 30m.

5.3.4 Construction of Shared Surfaces

Shared surfaces are to be an equivalent construction strength to that of the approach road. It is preferable that the surface treatment is visually and texturally different to that of the approach roads. The following may be used

- (i) Bituminous materials
- (ii) Blocks (Concrete or Clay).

The strengths and durability of any decorative finish will have to be proved acceptable to the Engineer. When considering decorative paving regard shall be given to the location of underground services and possible future reinstatement difficulties as well as the availability of similar paving for maintenance purposes.

5.3.5 Entry to Shared Surfaces

The entry shall only be by means of a footway/vehicular crossing and shall be of a red colour and of a different material to the adjacent carriageway and footway.

A shared surface off the road of a cul-de-sac must have a turning area constructed prior to the entry and must not attract extraneous traffic (including pedestrians and cyclists). (See Sketch no. 5.3.1).

5.3.6 Turning Facilities

Turning facilities shall be to the standards shown in Sketch 5.2.3.

5.3.7 Kerbs

A kerb with a minimum face of 50mm will be acceptable subject to the agreement of the Engineer as to the material to be used. Only small element units complying to BS 7263 should be used.

5.3.8 Verges

The verge (service strip) shall be constructed in lieu of the footway and be contiguous with the house garden with no boundary walls or fences to produce an open plan layout.

However, in exceptional circumstances where this can not be achieved early discussion with the Engineer is essential.

Developers should note that the verges will require special attention to ensure that the rights of the Highway Authority and Statutory Undertakers are protected and that these rights are fully understood by purchasers of the property and their successors. They must be made aware of the prohibition of building walls, fences, planting of hedges, trees, and deep rooting shrubs. In addition, the property owner is responsible for maintaining the verge as an extension of a lawn, and this is without prejudice to statutory rights of entry. Developers are reminded that the verge replaces a footway and this should not encourage encroachment of dwellings nearer to the highway than is permitted.

5.3.9 Surface to Vehicular Crossings

The surfacing to the Vehicular Crossings shall be in the same material as the carriageway surface course or a material approved by the Engineer.

5.3.10 Sketches

Typical examples are shown on Sketch no's 5.3.2 and 5.3.3.

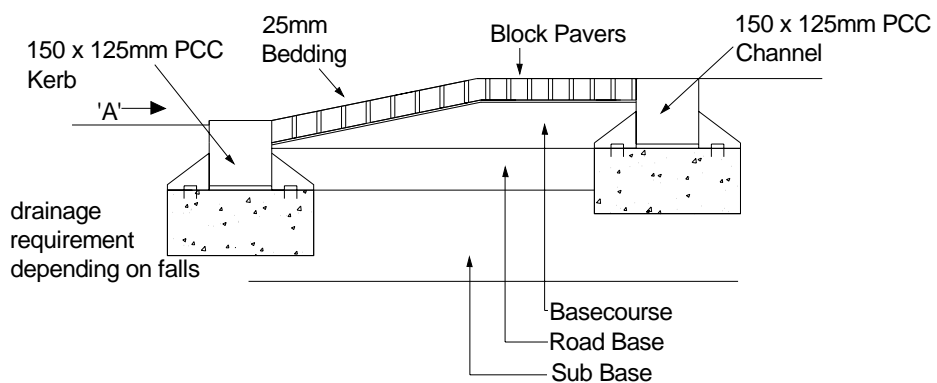
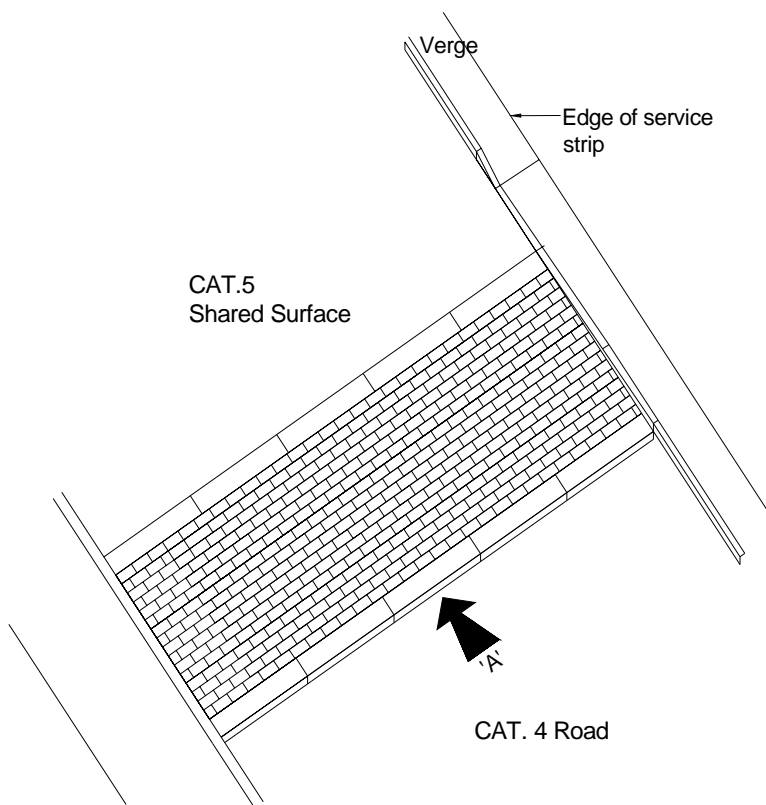



TYPICAL EXAMPLE OF A SHARED SURFACE

Sketch No. 5.3.2

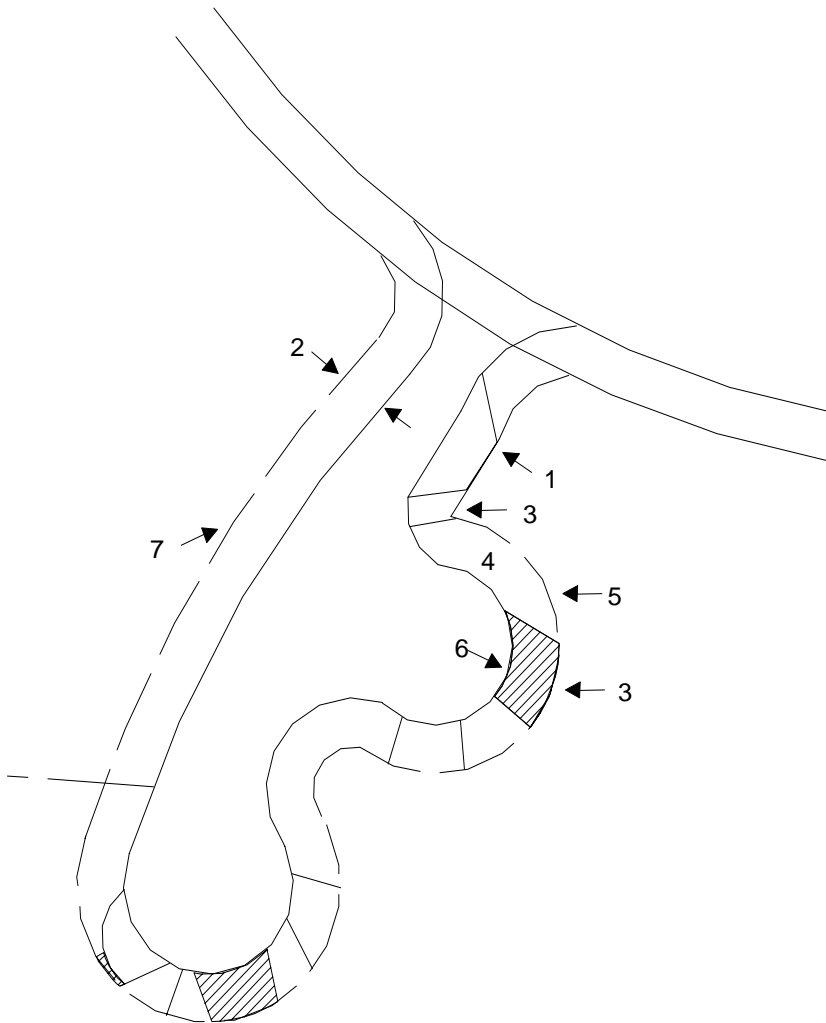

1. Services verge marker: blocks, bricks or similar permanent materials laid flush with drive to delineate high-way
2. Minimum verge width - 1.8m
3. Plot boundary marker to be used.
4. Planting limited to grass or ground cover to avoid damage to services.
5. No physical definition of boundary across the private garden.
6. Drive across verge built to footway crossing standards.

CONTENTS

<i>CLAUSE</i>	<i>TITLE</i>	<i>PAGE</i>
5.4.1	<u>DEFINITIONS</u>	45
5.4.2	<u>FOOTWAY AND FOOTPATH WIDTH</u>	45
5.4.3	<u>CROSSFALLS AND GRADIENTS</u>	45
5.4.4	<u>EMERGENCY ACCESS</u>	45
5.4.5	<u>SHARED SURFACES</u>	45
5.4.6	<u>RAMPS AND STEPS</u>	46
5.4.7	<u>CROSSING POINTS AND PEDESTRIANS</u>	46
5.4.8	<u>CONSTRUCTION</u>	46
5.4.9	<u>TACTILE PAVING</u>	46
5.4.10	<u>VEHICULAR CROSSINGS</u>	46

5.4 FOOTWAYS AND FOOTPATHS – GEOMETRY AND CONSTRUCTION STANDARDS

5.4.1 Definitions

A “Footway” is generally adjacent to a carriageway and over which the public have a right of way on foot only.

A “Footpath” is generally remote from a carriageway and over which the public have a right of way on foot only.

5.4.2 Footway and Footpath Widths

1.8m wide footways measured between restraints must be provided on both sides of the carriageway. However, for single sided developments a 1.8m highway verge may be provided in lieu of the footway fronting the open area. Independent footpaths are to be a minimum of 1.5m wide measured between restraints.

Footways and footpaths adjoining shopping frontage should be a minimum of 4m wide.

5.4.3 Crossfalls and Gradients

The maximum longitudinal gradient of footways and footpaths should be 5% (1 in 20) although this may be increased to 8% (1 in 12) subject to the approval of the Engineer.

Footpath drainage should be introduced where flows of surface water are liable to cause problems to adjacent areas. This footpath drainage is to be provided to the satisfaction of the Engineer. Footpath crossfall should be 2.5% to 4.0% (1 in 40 to 1 to 25).

5.4.4 Emergency Access

An emergency access (a secondary alternative route) should be provided for cul-de-sac in excess of 50 dwellings.

It may form part of a footpath system or be part of a public open space, having a minimum width of 3.7m and a maximum width of 4.5m. To allow for the passage of emergency vehicles when it is located within the footpath the sub base thickness shall be increased to 250mm. Within areas of public open space a 250mm layer of sub base shall be laid 100mm below finished ground level or alternatively with the approval of the Engineer a proprietary method of reinforcement may be used, i.e., grasscrete or netlon. Collapsible or removable bollards or fencing, with the agreement of the Engineer, should be provided at both ends of the access to prevent unauthorised vehicle access.

5.4.5 Shared Surfaces

Footpath links should not be provided into shared surfaces (see clause 5.3.5).

5.4.6 Ramps and Steps

Ramps for prams and invalid chairs must be provided as an alternative route where the use of steps is unavoidable. Handrails should be provided to at least one side of a flight of steps or ramps. Barriers or posts should be introduced to deter misuse.

5.4.7 Pedestrian Crossing Points

Pedestrian movement should be channelled to safe road crossing points so that conflict with vehicles is restricted. Care must be taken not to site pedestrian crossing points at gully locations.

5.4.8 Footway and Footpath Construction

The footways and footpaths shall be of flexible construction constructed in accordance with Section 10.9 of the Specification unless otherwise directed by the Engineer.

5.4.9 Tactile Paving

Tactile Paving should be provided to all pedestrian crossing points to Category 1 and 2 roads and elsewhere when requested by the Engineer.

The paving shall be red at controlled crossing points and buff at uncontrolled.

Dropped kerbs shall be introduced at all pedestrian crossings. (See Sketch 5.4.1).

In locations where footpaths cross over cycleways, the layout must be so designed as to give priority to the continuity of the footpath.

5.4.10 Vehicular Crossings

Vehicular crossings should be provided to all properties having incurtilage parking facilities. The crossing shall be a minimum of 2.5m wide with a transition kerb at either side and should be constructed in accordance with Clause 10.9.6. The width of the crossing should be increased in line with the width of the drive or if the access is not at right angles to the road.

The footway will be dished over this area with no abrupt change of slope and a maximum gradient of 8% (1 in 12).

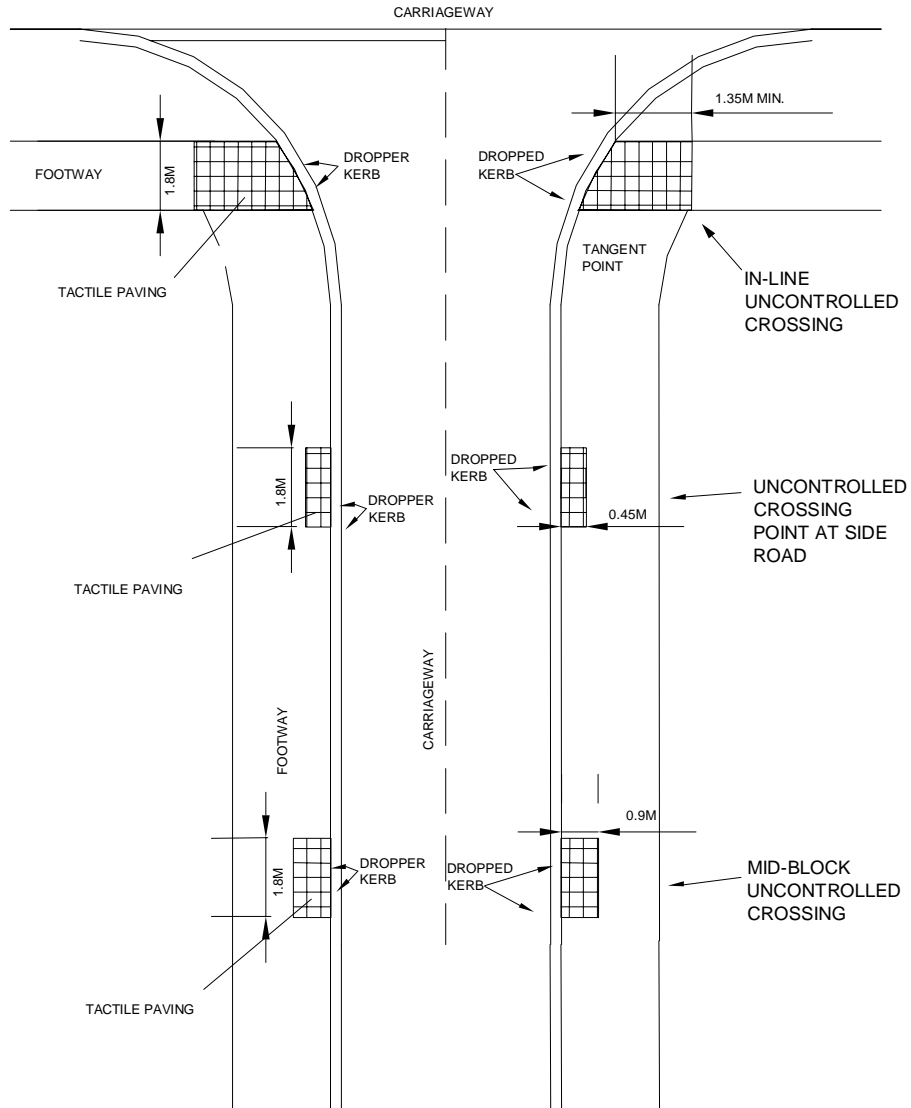

NOTES

1. Tactile paving, coloured buff shall be used at pedestrian crossing points to identify the existence of a dropped kerb and an appropriate place to cross.
2. Crossing points to be laid directly apposite each other with domes aligned in the direction of the crossing.

3. *The use of tactile paving shall be in accordance with the recommendation given in 'Guidance on the use of Tactile Paving Surfaces' published by DETR*

TYPICAL EXAMPLE OF PEDESTRIAN CROSSING POINT

Sketch No. 5.4.1

5.5 PARKING STANDARDS

Developers should fulfil the parking requirements as set out in Section 7.

It is important to note that the Highway Authority will not normally adopt parking facilities.

5.6 TRAFFIC CALMING

The requirements for traffic calming should be discussed at the earliest opportunity with the Engineer.

Detailed guidance is provided in Section 8.0.

5.7 CYCLING FACILITIES

The requirements for cycling facilities should be discussed at the earliest opportunity with the Engineer.

Detailed guidance is provided in Section 9.0.

5.8 STREET LIGHTING

The Developer is responsible for providing street lighting in accordance with Section 11.

5.9 HIGHWAY DRAINAGE

The Developer is responsible for providing highway drainage in accordance with Section 12.

5.10 HIGHWAY VERGES

The requirements for highway verges is given in Section 13.

5.11 STREET NAME PLATES

The Developer is responsible for providing temporary and permanent street name plates in accordance with Section 14.

The Developer shall ensure that prior to the occupation of the first dwelling within the development, the relevant street name plates, either temporary or permanent, are in place.

5.12 SIGNING AND ROAD MARKING

The Developer shall be responsible for providing signing and road markings to the satisfaction of the Engineer.

Road markings and traffic signs must conform to the Department of Transport Traffic Signs Manual and any amendments thereof., “The Traffic Signs Regulations and General Directions” and BS873.

5.13 PUBLIC SAFETY

Highway Authorities, Contractor and Statutory Undertakers have a civil law liability to warn road users of obstructions on the highway caused in connection with road works. All roadworks signing shall be to the satisfaction of the Highway Authority which has powers to prosecute for “non compliance”.

As a general guide, all works on roads used by members of the public, regardless of whether or not a road itself is yet adopted, should be carried out in accordance with the requirements of Chapter 8 of the “Traffic Signs Manual” published by HMSO, for the Department of Environment and any amendments thereof.

5.14 STATUTORY UNDERTAKERS APPARATUS

The provision of Statutory Undertakers apparatus should generally be in accordance with Sketch 5.14.1.

The Developer is reminded that all statutory mains must have been taken over by the relevant authority prior to the development being accepted for adoption.

5.15 VEHICULAR SERVICING OF COMMERCIAL PREMISES

Servicing of commercial premises shall be carried out within curtilage unless other acceptable provision can be made. Service roads will not be considered for adoption.

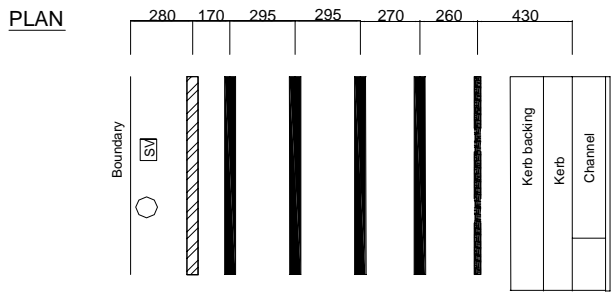
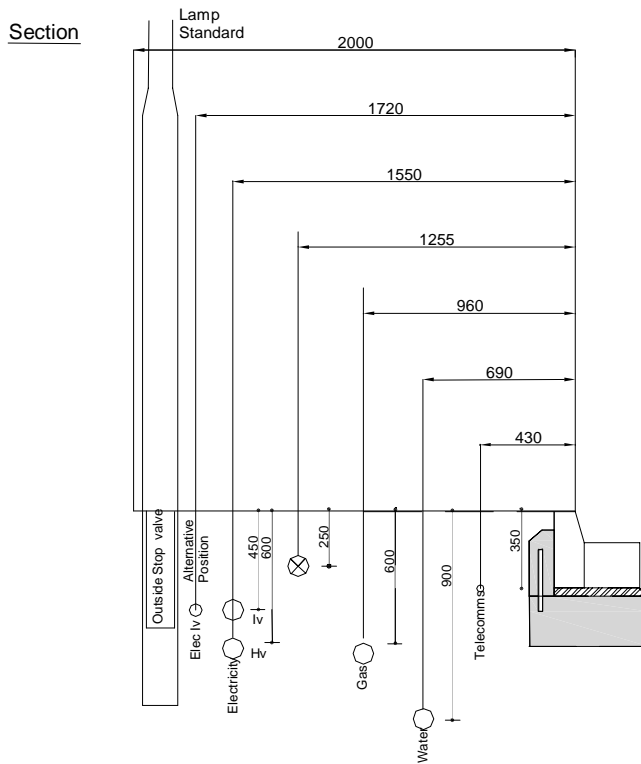

NOTES

1. The layout of Mains is generally in accordance with the "Report of Joint Committee on Location of Underground Services" published by the institution of Civil Engineers.
2. The dimensions shown represent the preferred arrangement in straight routes on residential estates. Variations may be necessary at curves and changes of gradient.
3. The space allocated is considered to be the absolute minimum and in certain circumstances e.g. where both h.v. and l.v. cables are laid, the l.v. cable will be laid in the alternative position and additional width may be required.
4. Where services are to be connected to gas mains, a minimum distance of 2.0m is required between the building line and the centre line of the main.

CONTENTS

<i>CLAUSE</i>	<i>TITLE</i>	<i>PAGE</i>
6.1	<u>HIERARCHY OF ROADS</u>	52
6.2	<u>CARRIAGEWAY – GEOMETRY AND CONSTRUCTION STANDARDS</u>	52
6.3	<u>FOOTWAYS AND FOOTPATHS – GEOMETRY AND CONSTRUCTION STANDARDS</u>	53
6.4	<u>PARKING STANDARDS</u>	54
6.5	<u>TRAFFIC CALMING</u>	54
6.6	<u>CYCLING FACILITIES</u>	54
6.7	<u>STREET LIGHTING</u>	54
6.8	<u>HIGHWAY DRAINAGE</u>	54
6.9	<u>HIGHWAY VERGES</u>	54
6.10	<u>STREET NAME PLATES</u>	54
6.11	<u>SIGNING AND ROAD MARKINGS</u>	54
6.12	<u>PUBLIC SAFETY</u>	54
6.13	<u>STATUTORY UNDERTAKERS APPARATUS</u>	54

6.0 INDUSTRIAL DEVELOPMENTS

6.1 HIERARCHY OF ROADS

6.1.1 **Industrial Distributor Roads** shall be used in large scale industrial developments. (This will generally apply where the industrial development is likely to generate more than 175 commercial vehicle trips per day). Access onto such roads should be restricted to Industrial Access Roads. There should therefore be no direct access to individual premises and the road should not form a cul-de-sac.

6.1.2 **Industrial Access Roads** are those roads onto which direct access is permitted and they should not attract more than 175 commercial vehicle trips per day. This type of road should not normally form a cul-de-sac, although this may be permissible in exceptional circumstances subject to a separate emergency access being provided which connects to an adopted highway.

6.2 CARRIAGEWAY – GEOMETRY AND CONSTRUCTION STANDARDS

6.2.1 **Design** – the design of all carriageways in industrial estate developments shall be carried out in accordance with the requirements of Section 5.2 of this document for category 1 roads, unless specifically amended by the following overriding clauses. A summary of the design requirements for industrial estates is detailed in Appendix 6.2.

6.2.2 **Junctions** – junctions of roads within industrial estates shall be a minimum distance of 90m apart where roads were located on one side of the major road, and 40m apart where junctions are formed on alternate sides of the major road. The minimum kerb radii at junctions shall be 12m.

6.2.3 **Carriageway Width** – the minimum carriageway width for all industrial estate roads shall be 7.3m, with local widening on bends where necessary using the method described in TD 9/93 – Highway Link Design.

6.2.4 **Visibility** – visibility at junctions and accesses should incorporate 9.0m x 90m visibility splays. A reduction in this standard may be acceptable but only in exceptional circumstances and with complimentary traffic calming measures.

6.2.5 **Embankments and Cuttings** – should the Developer propose to construct any embankment or cutting above 2.5m in height or depth, or with side slopes steeper than 1:3, then reference must be made to Dtp Vol 4 Design Manual for Roads and Bridges. All designs are to be submitted to the Engineer for approval prior to any work commencing on site.

6.2.6 **Horizontal curves** – horizontal curves shall have a minimum centre line radius of 60m. A reduction in this standard may be acceptable in exceptional circumstances, but only on Industrial Access Roads with complimentary local widening (see Clause 6.2.3).

6.2.7 **Vehicle turning facilities** – turning facilities are to be designed in accordance with Sketches 6.2.1 and these shall be provided on all culs-de-sac within industrial estate developments.

- 6.2.8 **Vehicular access to premises** – access to premises shall comply with the geometric standards detailed in sketch 6.2.1. The access width shall be 10m, although this may be reduced in circumstances where constraints on the types of vehicle using the site can be demonstrated, subject to the approval of the Engineer.

Any access shall be built using either the construction standards detailed in Sketch 6.2.2 or by using the construction standards applicable to the main carriageway.

Servicing of commercial premises shall be carried out within the curtilage unless other acceptable provision can be made to the approval of the Engineer. Service roads will not be considered for adoption.

- 6.2.9 **Emergency Access** – in circumstances where an industrial access road does form a cul-de-sac, a separate emergency access, which must be adopted, shall be provided and shall link between adopted highways.
- 6.2.10 **Carriageway Construction** – the structural design of carriageways for industrial access roads shall be in accordance with the construction standards for Category 1 Roads (see Appendix 6.2).

The structural design of carriageways for Industrial Distributor Roads shall be carried out in accordance with Dtp Vol 7 Design Manual for Roads and Bridges in consultation with the Engineer.

- 6.2.11 **Channels** – Channels shall not be utilised in the construction of industrial estate roads, unless otherwise agreed with the Engineer.
- 6.2.12 **Site Investigation Report** – The Developer shall supply to the Engineer a site investigation report prepared by a laboratory with appropriate UKAS accreditation which must include the sulphate content of ground water and soil (reference should be made to the detailed requirements of Clause 10.1).

6.3 FOOTWAYS AND FOOTPATHS – GEOMETRY AND CONSTRUCTION STANDARDS

- 6.3.1 The design of all footways and footpaths in industrial estate developments shall be carried out in accordance with the requirements of Section 5.4, unless specifically amended by the following overriding clauses.

All Industrial Access Roads shall include a 1.8m wide footway (measured between restraints) on both sides of the carriageway. However, for single sided developments, a 1.8m highway verge may be provided in lieu of the footway fronting the open area.

The footways shall normally be separated from the carriageway by 1.8m highway verge, which shall be constructed in accordance with the standards detailed in Section 10.9. In situations where omission of this verge is permitted, footways adjacent to the carriageway shall be constructed with the depth of binder course increased to 100mm and the sub-base to 250mm due to the greater vulnerability to vehicle overrun.

6.4 **PARKING STANDARDS**

- 6.4.1 Developers should fulfil the parking standards set out in Section 7, which must be outside the highway proposed for adoption.

6.5 **TRAFFIC CALMING**

- 6.5.1 Traffic calming may be considered for industrial estate roads. Such measures may be required where low vehicle flows and a high standard of carriageway design combine to encourage high vehicle speeds.

The design of traffic calming measures shall take account of the guidance given in Section 8 as applied to Category 1 Roads.

6.6 **CYCLING FACILITIES**

- 6.6.1 The design of cycling facilities in industrial estate developments shall be carried out in accordance with the requirements of Section 9. The Developer should consult with the Engineer at an early stage to determine the nature of cycling facilities to be included as part of the development.

6.7 **STREET LIGHTING**

- 6.7.1 The requirements of Section 11 apply equally to industrial estate developments.

6.8 **HIGHWAY DRAINAGE**

- 6.8.1 The requirements of Section 12 apply equally to industrial estate developments.

6.9 **HIGHWAY VERGES**

- 6.9.1 The design of highway verges in industrial estate developments shall be carried out in accordance with the requirements of Section 13 of this document.

6.10 **STREET NAME PLATES**

- 6.10.1 The requirements of Section 14 apply equally to industrial estate developments.

6.11 **SIGNING AND ROAD MARKING**

- 6.11.1 The requirements of Clause 5.12 apply equally to industrial estate developments.

6.12 **PUBLIC SAFETY**

- 6.12.1 The requirements of Clause 5.13 apply equally to industrial estate developments.

6.13 **STATUTORY UNDERTAKERS APPARATUS**

- 6.13.1 The requirements of Clause 5.14 apply equally to industrial estate developments.

APPENDIX 6.2
HIGHWAY DESIGN STANDARDS FOR INDUSTRIAL DEVELOPMENTS

ROAD TYPE	MINIMUM CARRIAGEWAY WIDTH (metres)	MINIMUM FOOTWAY WIDTH (metres)	DESIGN SPEED (km/h)	STOPPING DISTANCE (metres)	MINIMUM CENTRE LINE RADIUS (metres)	MINIMUM JUNCTION SPACING (metres)	
						Adjacent	Opposite
Industrial Estate Distributor Road	7.3	1.8	50	90	60	90	40
Industrial Estate Access Road	7.3	1.8	40	90 ¹	60	90	40

MINIMUM JUNCTION KERB RADII (metres)	JUNCTION VISIBILITY SPLAY (metres)		VISIBILITY HEIGHT (metres)	MAXIMUM CARRIAGEWAY GRADIENT	MAXIMUM SUPER ELEVATION
	X-distance	Y-distance			
12	9	90	2.00/1.05 to 2.00/1.05	5%	5%
12	9	90 ¹	2.00/1.05 to 2.00/1.05	5%	5% ²

Notes:

1. This may be reduced in certain circumstances with the agreement of the Engineer.
2. This may be relaxed in situations where low vehicle speeds can be demonstrated.

'T' Type

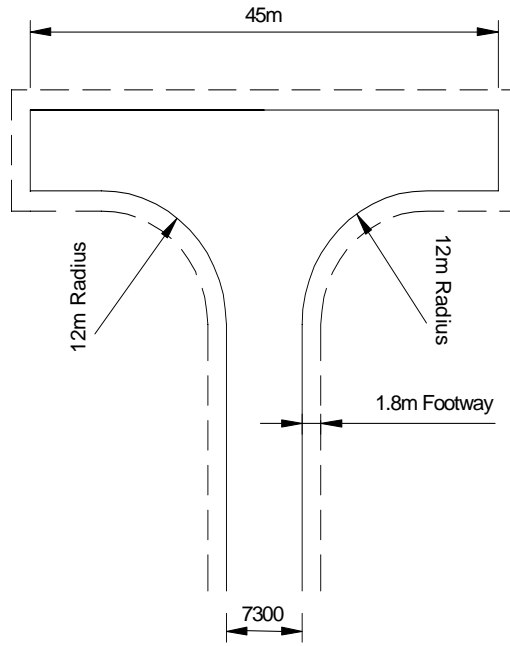

'Key' Type

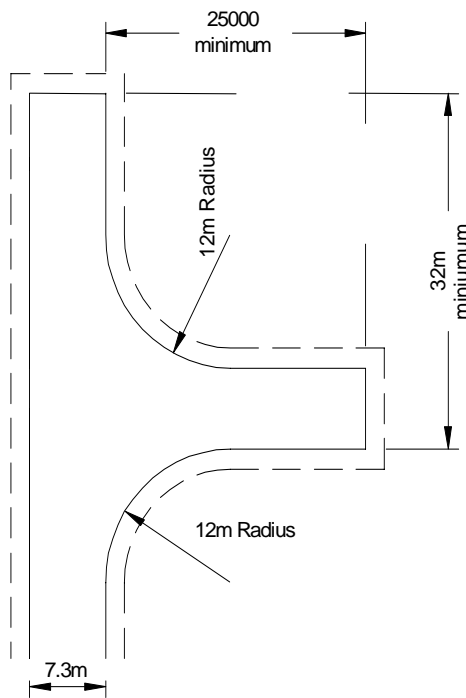

Note: A 1.8m wide footway must always be provided, as indicated above

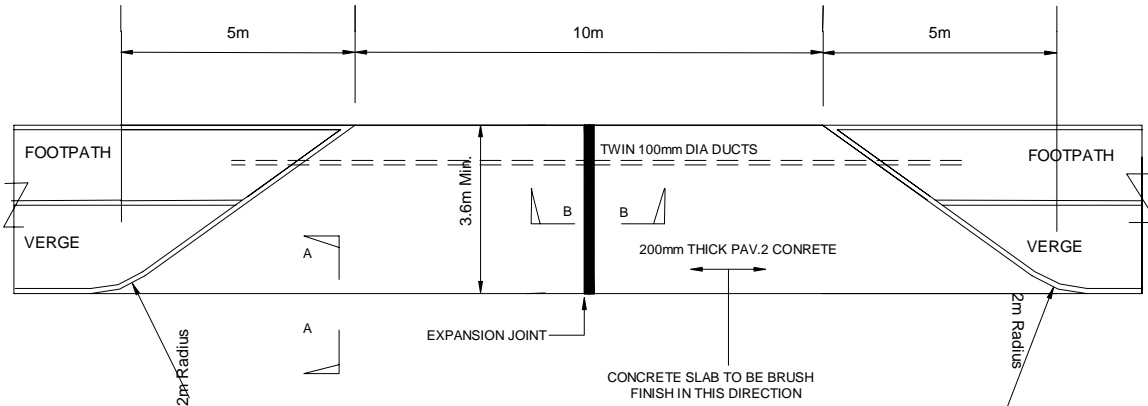

Note:
Joint edges to be arised and filled with joint sealing compound

PLAN SHOWING CONSTRUCTION OF STANDARD

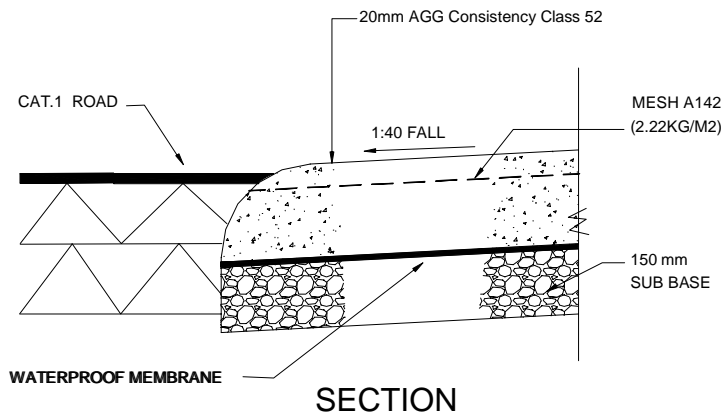

SECTION

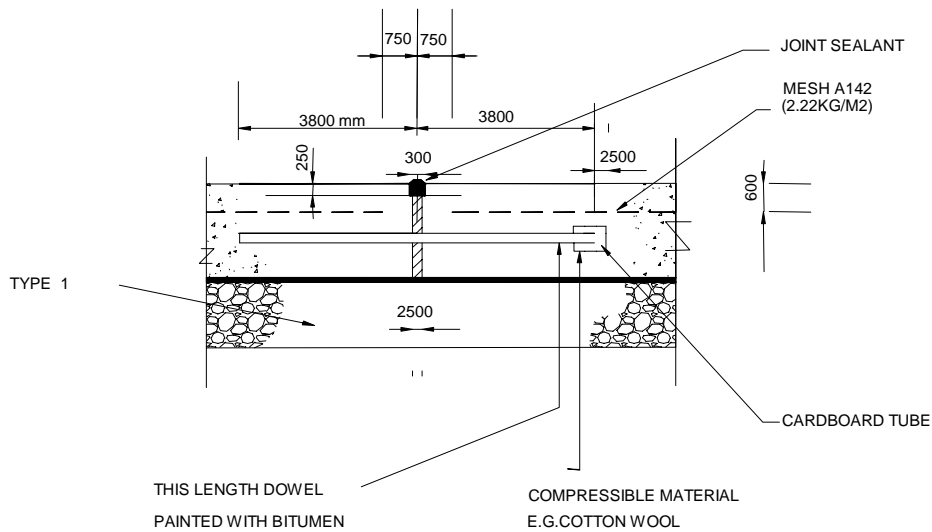

SECTION

CONTENTS

<i>CLAUSE</i>	<i>TITLE</i>	<i>PAGE</i>
7.1	<u>INTRODUCTION</u>	59
7.2	<u>CYCLISTS</u>	60
7.3	<u>ALTERNATIVE STRATEGIES</u>	61
7.4	<u>PERSONS WITH DISABILITIES</u>	61
7.5	<u>LEVELS OF DEMAND</u>	62
7.6	<u>DIFFERENTIAL STANDARDS CENTRAL/ NON-CENTRAL AREAS</u>	63
7.7	<u>OPERATIONAL/NON-OPERATIONAL PARKING</u>	64
7.8	<u>FRINGE AREAS</u>	64
7.9	<u>ADOPTION OF PARKING AREAS</u>	65
7.10	<u>USE CLASSES ORDER</u>	65
7.11	<u>PARKING STANDARDS</u>	68
	Residential.....	69
	Business Use.....	71
	Retail.....	71
	Warehouse.....	73
	Motor Car.....	73
	Places of Assembly.....	74
	Sports and Leisure.....	74
	Health Facilities.....	76
	Education.....	77
	Food and Drink.....	79
	Hotels.....	79

7.0 PARKING STANDARDS

7.1 INTRODUCTION

7.1.1 The Need to Manage Demand

Every development results in a demand for parking or loading space. This demand must, however, be viewed in the context of the Government's Sustainable Development Strategy. The approach to this strategy is outlined in regard to parking in Department of Transport/Department of Environment Planning Policy Guidance Note 13, (PPG13).

The aim of this policy is to;

reduce growth in the length and number of motorised journeys;

encourage alternative means of travel which have less environmental impact and hence reduce reliance on the private car.

The aims are intended to assist in sustaining existing centres.

The availability of parking has a major influence on the choice of means of transport.

PPG 13 suggests that levels of parking can be more significant than levels of public transport provision in determining means of travel. In considering parking, therefore, the effects of the level of provision must take into account the impact on vehicle trips and the need to address the encouragement of alternative modes of travel, in particular public transport, cycling and walking.

Local authorities should aim to influence the need to travel by, amongst other means, limiting parking provision for developments where there are effective alternatives. In principle and in practice this means that standards are reduced below the levels considered appropriate when full parking, as a minimum provision, was expected.

In general, therefore the following principles apply,

- (i)* Reduced requirements for parking for locations which have good access to other means of travel than the private car.
- (ii)* Flexibility in regard to off-street residential parking provision particularly in association with high density development in areas with good access to other forms of travel.
- (iii)* Parking provision at peripheral sites is not set at a level which would disadvantage more central areas.

Car parking is only one element in the strategy for securing sustainable development. An integrated approach is necessary and as a consequence ways of reducing travel, influencing traffic growth and improving environmental impacts of transport are evolving and will continue to do so. These will be presented in local policy and strategy documents and hence early consultation with the Engineer is recommended.

7.2 CYCLISTS

One of the main aims of the latest advice is to give strong emphasis on the need to provide for alternative means of travel, walking, cycling etc. In particular provision should be made at new development for the needs of cyclists. The consideration of such needs will be fourfold,

- level of provision,
- type of provision,
- location of provision and
- facilities for commuter cyclists to shower and change.

Consideration must be given to the provision of cycle parking facilities in conjunction with all new development. Such facilities will be considered essential in all significant developments, e.g. an office development of more than 200m², or a retail development of a similar size gross floor area.

Cycle parking provision should be conveniently sited and located adjacent to well used pedestrian routes or be overlooked by adjacent properties.

Ideally these would take the form of an enclosed secure facility for commuter or long stay provision but, in general, the Sheffield Stand or alternative satisfactory wall bar provision will be acceptable for short term use.

FIGURE 7.2.1



Developers should be mindful that the needs of commuter users will be different from those of the short term user.

Their siting and design should take into consideration environmentally sensitive locations and pedestrian access and should also incorporate specific security lighting where appropriate.

The cycle parking standards indicated should be considered as the minimum provision although it should be noted that this is an area where requirements are likely to evolve in the light of experience.

7.3 ALTERNATIVE STRATEGIES

Taking into account consideration of PPG13 it is likely that parking standards will be reduced for most types of development. Any reduction would take into account, however, the availability of alternative travel modes.

As part of the consideration of development, it is expected that any significant development, (e.g. a residential development of more than 200 dwellings or retail development of more than 1000m²), irrespective of the level of parking provision, will require a travel plan, unless directed otherwise by the Engineer. This should indicate measures to provide and maintain alternative transport provision and the Developer could be expected to contribute to their provision and maintenance. Dependent on circumstances this contribution could be up to 100%.

The elements of a travel plan would include examination of matters such as bus lay-bys, bus shelters, cycle parking, pedestrian links, supported services, travel passes for staff, car sharing, travel allowances for cycling etc.

Where parking cannot be provided on site or where reduced standards are accepted it may be appropriate, in the context of PPG13, to seek commuted sums either for the provision of alternative parking facilities or as contributions to measures to assist public transport, walking or cycling. These measures would typically take the form of bus lay-bys, support to bus services, cycleway provision or engineering methods to enhance or ensure pedestrian/cycling safety.

The appropriateness and relevance of commuted payments will be considered in the context of the circumstances of development and as local policies and strategies evolve.

7.4 PERSONS WITH DISABILITIES

In accordance with national guidance consideration should always be given to the need for provision for those without full mobility. Location is particularly important and allocated spaces should be as close as possible to the destination, sufficiently large to allow wheelchair access and connected to the destination without steps. Ramps or lifts may be necessary.

The location of such spaces in a development should be considered at an early stage to achieve a balanced distribution of spaces throughout the site. The width of a parking space provided for disabled people should be 3.3m.

The recommended number of disabled spaces will vary in accordance with the type and capacity of car parks as follows:-

- (i) For car parks associated with employment premises and provided for employees and visitors:

Up to 200 spaces: 5% of capacity, subject to a minimum of 2 spaces, to be reserved.

Over 200 spaces: 2% plus 6 spaces.

Spaces for disabled employees should be additional to those recommended above; reservations could be ensured, for example, by marking a space with a registration number.

- (ii) For car parks associated with shopping areas, leisure or recreational facilities, and places open to the general public:

Up to 200 spaces: 6% of capacity subject to a minimum of 3 spaces, to be reserved;

Over 200 spaces: 4% plus 4 spaces.

Developers are advised that in all car parks, the use of the reserved spaces should be monitored regularly to confirm that these recommended numbers are appropriate – too few will cause problems for disabled motorists, while too many will generate resentment among non-disabled motorists, and may encourage them to abuse the reserved spaces.

Guidance is available in **BS8300:2001 for**

- (i) The provision **and design** of parking bays designated for disabled people in different building types.
- (ii) Ticket dispensing machines.
- (iii) Vehicular control barriers.
- (iv) Multi-storey car parks.

7.5 LEVELS OF DEMAND

Different types of development produce different levels of demand and indeed developments within the same category (e.g. retailing activities) may generate widely differing requirements.

Lack of adequate car parking results in on-street parking, creating specific problems which may be potentially dangerous. These problems can be identified as:-

- interfering with pedestrian/vehicular intervisibility;
- loss of highway capacity thus creating congestion;
- visual intrusion.

These standards are intended to offer guidance on the appropriate level of provision to be achieved in conjunction with different forms of land use. The standards should be taken as indicative of the level of demand normally expected in the Tees Valley area.

It is also expected that the level of provision in non-central areas will be a maximum and, indeed, in some circumstances there may be no minimum level of provision.

Parking provided in conjunction with any development should be convenient to that development.

Prospective developers are advised to consult with the Engineer in cases of doubt.

7.6 DIFFERENTIAL STANDARDS CENTRAL/NON-CENTRAL AREAS

It is intended that there should be a distinction in levels of provision between central area and non-central area development. Within central areas developers will normally be allowed to provide for operational requirements only, whilst outside these areas provision for the parking standard specified will be required.

This policy is designed to achieve a number of objectives. It will minimise the inefficient use of high value land in town centres and will also allow the Local Authority to retain control over the extent and use of off-street parking provision. This is an important part of the overall transport and land use policy.

Insistence on developers meeting the parking needs of non-operational traffic associated with individual development proposals within town centres will tend to result in the haphazard distribution of private car parks, not necessarily related to the local road network. The existence of unrelated and unregulated car parks to which access must be maintained acts as a serious constraint reducing the scope and effectiveness of traffic plans designed to rationalise and improve vehicular and pedestrian circulation.

In particular the existence of access points to and the movement of vehicles associated with individual private car parks tends to disrupt the free flow of traffic and exacerbates congestion.

On the other hand concentrating provision for non-operational parking in town centres in the form of strategically located car parks available to the general public and with good access arrangements encourages the more efficient operation of commercial centres and at the same time facilitates the formulation and implementation of effective car parking policies and traffic management schemes for town centres.

The control of town centre parking also allows the Highway Authority to influence strategic transportation issues such as the balance of transportation modes between private, personal and public transport.

In short a policy of parking management in central areas is an invaluable tool in the strategic operation of town centre traffic policy. A policy which can only be regulated comprehensively by the Local Authority.

Town Centre definition is not incorporated in the car parking standards but is included in the Local Plan. Developers are asked to contact the relevant Local Authority to clarify the extent of the defined area in case of doubt.

Where specific Town Centre provision is not referred to, the level of provision can be taken to be 10% of the required provision for non-central areas. Exception to this requirement will be made where a development is likely to create a particular significant demand. In such cases the Highway Authority could seek an increased provision of up to 100% of the standards specified. The question of a financial contribution to off-site parking in lieu of this is an option and the appropriateness of this will be considered in the future as local policies and strategies evolve.

7.7 OPERATIONAL/NON-OPERATIONAL PARKING

Operational parking is defined as the space required for cars and service vehicles necessarily involved in the operation of the business of particular buildings. It comprises space for vehicles servicing premises, primarily commercial vehicles delivering or collecting goods. In addition to the space required for loading and unloading, operational parking also includes space for picking up and setting down passengers. It does not normally include customer/client parking unless this is necessary as part of the business being carried out (e.g. vehicle servicing/tyre/exhausts).

Non-operational parking is defined as the space required for vehicles, mainly private cars, which do not necessarily have to park or wait on the site of particular premises. This definition includes customer and employee 'privilege' parking.

There will be some exceptions to the above general rule. Particular developments may create such significant parking demands that the absence of non-operational spaces will result in unacceptable pressure on existing facilities. Such a situation is likely to arise in large scale office/commercial developments or particularly in conjunction with major retail proposals. In such situations the Local Authority will almost certainly require the provision of suitable alternative facilities or a contribution as detailed in Section 7.3.

Some parking provision may be required in conjunction with residential development in central areas. This provision takes into account the opportunity of allowing residents the choice between public/private transport. It also allows for greater personal and vehicle security. Visitor provision will take into consideration the availability of adjacent public parking.

In all areas developers will be expected to provide the advised car parking as a maximum.

7.8 FRINGE AREAS

In fringe areas immediately adjoining a central area where public parking is provided by the Local Authority, a development may be assumed, where appropriate, to use some public parking as part of its non-Central Area provision by agreement with the Local Authority.

7.9 ADOPTION OF PARKING AREAS

Developers are advised that the parking requirements set out in this section should be fulfilled in areas not intended to be adopted by the Highway Authority. In general it would be expected that all parking will take place in curtilage. In instances where this is not practical, consideration will be given to adopting parking areas provided solely for visitors which are contiguous with the highway and are closely related to the dwellings they are intended to serve.

A car parking space in a car park will normally be 2.4m x 4.8m with adequate space to manoeuvre in and out. An in curtilage space will normally be 6m but in constrained circumstances this may be reduced to 5m.

Aisle widths in the parking arrangements for 90 parking shall be a minimum of 5.5m for one way access and 6.0m for two way access. Where echelon parking less than 90 is provided, one way access shall be employed and the minimum aisle width shall be as Table 7.1

TABLE 7.1

ANGLE OF PARKING	MIN. AISLE WIDTH (m)
60°	4.2
45°	3.7

Sketch no. 7.9.1 gives some indicative parking arrangements.

7.10 USE CLASSES ORDER

It is clear that some developments within the same use class Order will have widely differing parking requirements (e.g. category A3 public houses/hot food take-aways, B1 Industrial Use).

Under normal circumstances, therefore, a Planning Authority may be advised, on consultation, that the use should be restricted to that specifically applied for (assuming of course that appropriate parking provision can be achieved) commensurate with the level of parking provision.

A Section 106 Agreement (Town & Country Planning Act 1990) may be required in this respect.

A breakdown of the Use Classes Order and the permitted changes of use within it is shown in Table 7.2.

TABLE 7.2:

USE CLASSES ORDER 1987	USE CLASSES ORDER 1972	DESCRIPTION	GENERAL DEVELOPMENT ORDER 1988
A1 Shops	Class I	Shops, retail warehouses, hairdressers, undertakers, travel and ticket agencies, post offices, dry cleaners etc. Pet shops, cats-meat shops, tripe shops, sandwich bars, Showrooms, domestic hire shops, funeral directors.	No permitted change
A2 Financial and Professional Services	Class II	Banks, building societies, estate and employment agencies Professional and financial services, betting offices	Permitted change to A1 where a ground floor display window exists
A3 Food and Drink		Restaurants, pubs, snack bars, cafes, wine bars, shops for sale of hot food	Permitted change to A1 or A2
Sui Generis		Shops selling and/or displaying motor vehicles Launderettes, taxi or vehicle hire businesses, amusement centres, petrol filling stations.	Permitted change to A1 No permitted change
B1 Business a) b) c)	Class II Class III	Offices, not within A2 Research and development, studios, laboratories, high tech Light industry	Permitted change to B8 where no more than 235m ²
B2 General Industrial	Class IV - IX	General industrial	Permitted change to B1 or B8 limited to no more than 235m ²
B8 Storage or Distribution	Class X	Wholesale warehouse, distribution centres, repositories	Permitted change to B1 where no more than 235m ²
Sui Generis		Any work registerable under the Alkali, etc Works Regulations Act 1906	No permitted change
C1 Hotels	Class XI	Hotels, boarding and guest houses	No permitted change
C2 Residential Institutions	Class XII Class XIV	Residential schools and colleges Hospitals and convalescent/nursing homes	No permitted change
C3 Dwelling Houses		Dwellings, small businesses at home, communal housing of elderly and handicapped	No permitted change
Sui Generis		Hostel	No permitted change
D1 Non-residential	Class XIII Class XV Class XVI	Places of worship, church halls Clinics, health centres, crèches, day nurseries, consulting rooms Museums, public halls, libraries, art galleries, exhibition halls,	No permitted change
D2 Assembly and Leisure	Class XVII Class XVIII	Cinemas, music and concert halls Dance, sports halls, swimming baths, skating rinks, gymnasiums Other indoor and outdoor sports and leisure users, bingo halls, casinos	No permitted change
Sui Generis	Class XVII	Theatres	No permitted change

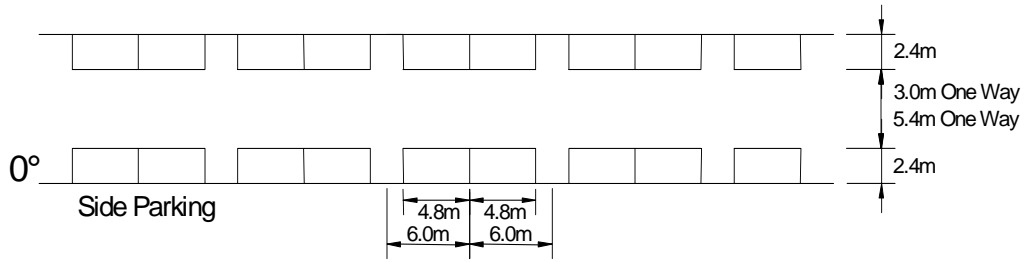

Alternative Parking Layouts

N.B. These arrangements are not normally acceptable adjacent to highways

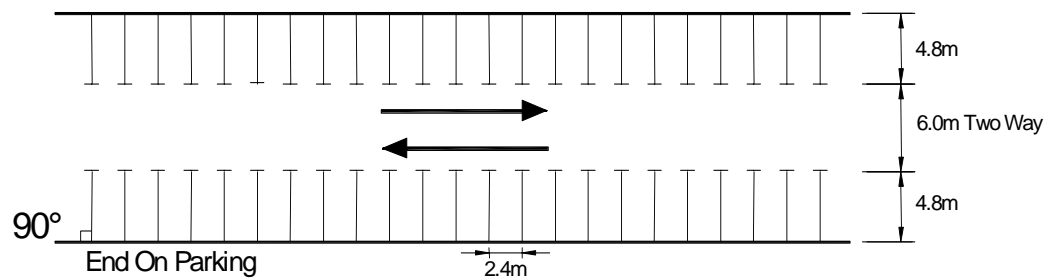
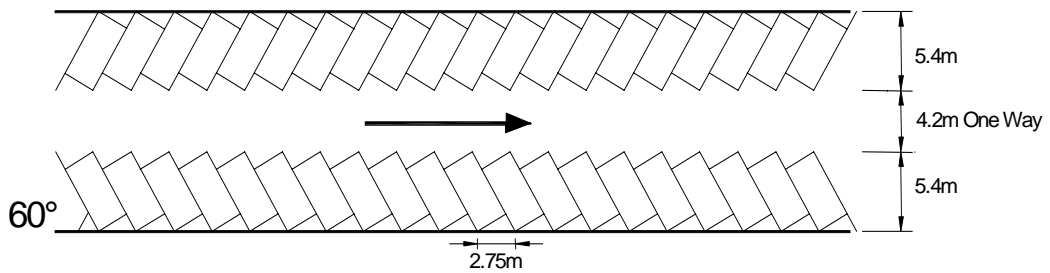
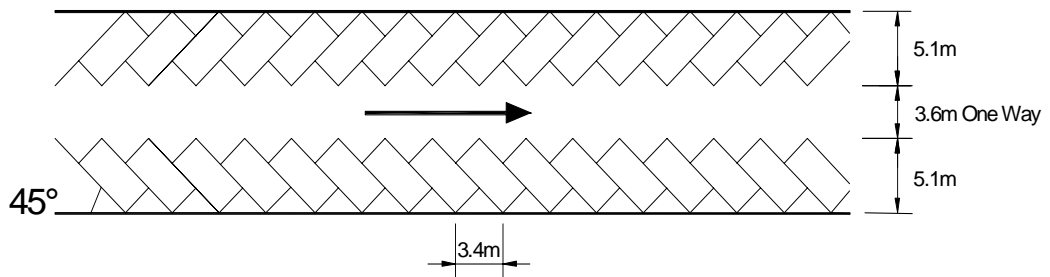
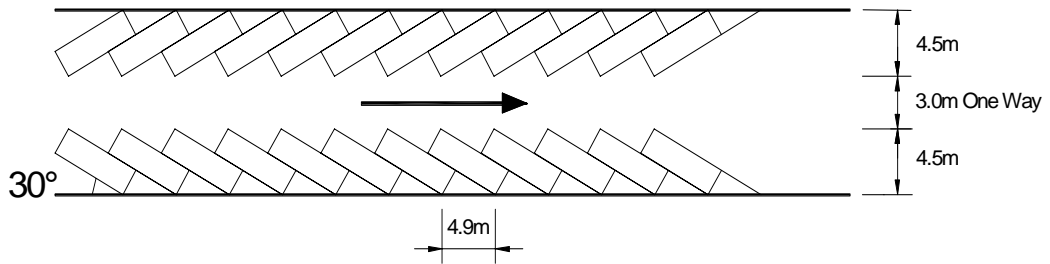

7.11 PARKING STANDARDS

In all areas advised car parking levels will generally be the maximum provision.

Minimum levels must be agreed with the Local Authority.

Where no provision for a Use Type is specifically mentioned each case will be considered on its merits in discussion with the Local Authority.

In any situation developments which unduly exacerbate road safety or on-street parking problems will not be acceptable.

Car parking provision will normally be expected to be provided in curtilage.

LAND USE	USE CLASS	PARKING REQUIREMENTS	
		Non Central Areas	Central Areas
RESIDENTIAL Houses and Flats	C3	<p>Normal requirements for a dwelling are 2 spaces per household. This includes both visitor and residents parking. In a conventional development this provision is expected to consist of a garage and driveway (the driveway must be at least 6m in length from the back of footpath).</p> <p>In low density development some consideration may be given to the provision of 1 space per bedroom (in excess of 3) above normal provision.</p> <p>In situations of high density development or where low car ownership can be demonstrated which is unlikely to increase significantly 1 space or garage must be provided within the curtilage. Visitor parking on a communal basis should be provided to the standard of 0.5 spaces per dwelling.</p> <p>Flatted development will justify the provision of cycle parking on the basis of 1 space per 4 dwellings secure covered storage for residents and 1 space per 6 dwellings for visitors.</p>	<p>One space per dwelling. This provision may be reduced if the site is located in area which is readily accessible to facilities by public transport, cycling and walking.</p> <p>In addition some consideration may be given to a reduction in the required standard if available public car parking can be readily utilised. Such communal facilities must be readily accessible and convenient in use. This provision may be further reduced if the site is located in an area which is readily accessible to facilities by public transport, cycling and footpath links.</p> <p>Flatted development will justify the provision of cycle parking on the basis of 1 space per 4 dwellings secure covered storage for residents and 1 space per 6 dwellings for visitors.</p>
Multi-occupancy/ conversions	C3	<p>1.5 spaces per household is the maximum provision.</p> <p>This incorporates 1 space per household for residents + 0.5 spaces per household for visitors. 1 space per dwelling will normally be acceptable. In difficult situations, particularly within central areas and areas normally accepted for multi-occupancy uses individual cases will be treated on their merits.</p> <p>Flatted development will justify the provision of cycle parking on the basis of 1 space per dwellings secure covered storage for residents and 1 space per 6 dwellings for visitors.</p> <p>Parking provision may be further reduced if the site is located in an area which is readily accessible to facilities by public transport, cycling and footpath links</p>	<p>As above.</p> <p>Flatted development will justify the provision of cycle parking on the basis of 1 space per 4 dwellings secure covered storage for residents and 1 space per 6 dwellings for visitors.</p>

LAND USE	USE CLASS	PARKING REQUIREMENTS	
		Non Central Areas	Central Areas
Local Authority/ Housing Association	C3	<p>Demand for off-street parking in Local Authority/Housing Association development tends to be lower than that in the private sector. Accordingly the standard of parking provision is reduced. Initial provision of 0.75 spaces per dwelling comprising 0.25 for visitors and 0.5 spaces for residents. Maximum ultimate provision is 1.50 spaces in total. The location of this ultimate provision must be clearly indicated and retained for future use.</p> <p>Provision may be further reduced if the site is located in an area which is readily accessible to facilities by public transport, cycling and footpath links.</p> <p>Flatted development will justify the provision of cycle parking on the basis of 1 space per 4 dwellings secure covered storage for residents and 1 space per 6 dwellings for visitors.</p>	<p>As non central area initial provision.</p> <p>Provision may be further reduced if the site is located in an area which is readily accessible to facilities by public transport, cycling and footpath links. Flatted Development will justify the provision of cycle parking on the basis of 1 space per 4 dwellings secure covered storage for residents and 1 space per 6 dwellings for visitors.</p>
Elderly Persons Dwellings	C3	<p>1 space per dwelling to include for both residents and visitors.</p> <p>This type of accommodation would normally be intended for residents over 65 years and restricted to 1 bedroom units.</p>	<p>As non central area provision.</p>
Sheltered Housing	C3	<p>Housing where residents care for themselves with some warden or care assistance.</p> <p>2 spaces per resident warden.</p> <p>1 space per 5 residents (visitor parking).</p> <p>Servicing area.</p>	<p>1 space per resident.</p> <p>1 space per 10 residents (visitor parking).</p> <p>Servicing area.</p>
Residential Care Homes/ Elderly Persons Home	C2	<p>Sufficient operational parking and area for manoeuvring within the site.</p> <p>2 spaces per resident staff.</p> <p>1 space per 3 members of staff on duty at one time.</p> <p>1 space per 8 residents (visitor provision).</p> <p>1 space for professional visitor.</p>	<p>Sufficient operational parking and area for manoeuvring within the site.</p> <p>1 space per resident staff.</p> <p>1 space per 5 members of staff on duty at one time.</p> <p>1 space per 10 residents (visitor provision).</p> <p>1 space for professional visitor.</p>

LAND USE	USE CLASS	PARKING REQUIREMENTS	
		Non Central Areas	Central Areas
Residential Institutions	C2	<p>Sufficient operational parking and area for manoeuvring within the site.</p> <p>1 space per 2 staff.</p> <p>Space per 2-5 residents/occupants dependent on specific use.</p> <p>Provision for the parking of 1 cycle per 5 employees.</p>	<p>Sufficient operational parking and area for manoeuvring within the site.</p> <p>In all cases development will be treated on its merits. For guidance developers may assume that the maximum provision will be 1 space per residential unit which, dependent on location and accessibility, may be reduced to provision for operational parking only.</p> <p>Provision for the parking of 1 cycle per 5 employees.</p>
BUSINESS USE Offices	B1 A2	<p>Sufficient operational parking and area for manoeuvring within the site.</p> <p>1 space per 35m² gross floor area.</p> <p>Provision for the parking of 2 cycles per 200m² gross floor area.</p>	<p>Sufficient operational parking and area for manoeuvring within the site.</p> <p>1 space per 350m² gross floor area.</p> <p>Provision for the parking of 2 cycles per 200m² gross floor area.</p>
Industrial	B1/B7	<p>Sufficient operational parking and area for manoeuvring within the site.</p> <p>1 space per 45m² gross floor area or 4 spaces per 10 employees (whichever is the greater).</p> <p>Provision for the parking of 2 cycles per 200m² gross floor area.</p>	<p>Sufficient operational parking and area for manoeuvring within the site.</p> <p>1 space per 450m² gross floor area or 4 spaces per 100 employees (whichever is the greater).</p> <p>Provision for the parking of 2 cycles per 200m² gross floor area.</p>
<p>Note: There is a range of parking requirements within the use of Class B1. Unless the highest parking standard (1 per 30m² - see High Tech below) is provided then a conditional approval only may be advised which links development to the lower parking standard provided.</p>			
High Tech	B1	<p>Sufficient operational parking and area for manoeuvring within the site.</p> <p>1 space per 30m² gross floor area or 1 space per 2 employees (whichever is the greater).</p> <p>Provision for the parking of 2 cycles per 200m² gross floor area.</p>	<p>Provision for the parking of 2 cycles per 200m² gross floor area.</p> <p>1 space per 300m² gross floor area or 1 space per 20 employees (whichever is the greater).</p> <p>Provision for the parking of 2 cycles per 200m² gross floor area.</p>
RETAIL Supermarkets/ Warehouses	A1	<p>Sufficient operational parking and area for manoeuvring within the site.</p>	<p>Sufficient operational parking and area for manoeuvring within the site.</p>

LAND USE	USE CLASS	PARKING REQUIREMENTS	
		Non Central Areas	Central Areas
		<p>The range of activities within this category is wide and there are significant differences in the likely parking demand.</p> <p>A developer may assume that a range between 2 to 8 car spaces per 100m² of floor area gross may be required.</p> <p>The decision on the actual numbers will be based mainly in the type of retail activity envisaged.</p> <p>For guidance developers should appreciate that food retailing is likely to justify the higher end of this range. DIY is likely to justify the middle of the range. Precise parking levels in large developments will be established by an agreed Traffic Impact Assessment.</p> <p>Provision for the parking of 2 cycles per 200m² gross floor area.</p> <p>The Local Authority may require a condition or a Section 106 Agreement limiting the retail use to suit the available parking.</p>	<p>Town Centre development will normally require parking levels of a similar order. However, the availability of existing off street car parking will be taken into account.</p> <p>The Local Authority may require that such car parking provision as is required must be under LA control or that this provision could be located away from the site as part of the general central area car parking requirements. This would necessitate the applicant entering into an agreement with the LA to provide a commuted sum.</p> <p>Provision for the parking of 2 cycles per 200m² gross floor area.</p>
Shops	A1	<p>Sufficient operational parking and area for manoeuvring within the site.</p> <p>1 space per 30m² gross floor area.</p> <p>Provision for the parking of 2 cycles per 100m² gross floor area or per unit. Whichever is the greater.</p>	<p>Sufficient operational parking and area for manoeuvring within the site.</p> <p>1 space per 300m² gross floor area.</p> <p>Provision for the parking of 2 cycles per 100m² gross floor area or per unit. Whichever is the greater.</p>
Garden Centres	A1	<p>Sufficient operational parking and area for manoeuvring within the site.</p> <p>1 space per 30m² GDA (Gross Display Area).</p> <p>Provision for the parking of 2 cycles per 200m² GDA.</p>	<p>Sufficient operational parking and area for manoeuvring within the site.</p> <p>1 space per 300m² GDA (Gross Display Area).</p> <p>Provision for the parking of 2 cycles per 200m² GDA.</p>
Car Boot Sales	Sui generis	<p>Sufficient operational parking and area for manoeuvring within the site.</p> <p>1 space per stall/pitch for sellers.</p> <p>3 spaces per stall/pitch for customers.</p> <p>Provisions for the parking of 4 cycles per 500m² GDA.</p>	<p>Sufficient operational parking and area for manoeuvring within the site.</p> <p>1 space per stall/pitch for sellers.</p> <p>30 spaces per stall/pitch for customers.</p> <p>Provisions for the parking of 4 cycles per 500m² GDA.</p>

LAND USE	USE CLASS	PARKING REQUIREMENTS	
		Non Central Areas	Central Areas
WAREHOUSES	B8	<p>Sufficient operational parking and area for manoeuvring within the site.</p> <p>1 space per 100m² gross floor area or 1 space per 2 employees (whichever is the greater).</p> <p>Provision for the parking of 2 cycles per 400m² gross floor area.</p>	<p>Sufficient operational parking and area for manoeuvring within the site.</p> <p>1 space per 1000m² gross floor area or 1 space per 20 employees (whichever is the greater).</p> <p>Provision for the parking of 2 cycles per 400m² gross floor area.</p>
MOTOR CAR Showrooms	Sui generis	<p>Sufficient operational parking and area for manoeuvring within the site.</p> <p>For guidance a main dealership would be expected to provide a minimum of 100 spaces on site for service and sale vehicles.</p> <p>1 space per 100m² internal/external display area for customers.</p> <p>0.75 space per member of staff.</p> <p>Provision for the parking of 2 cycles per 500m² gross floor area or per outlet. Whichever is the greater.</p>	<p>Sufficient operational parking and area for manoeuvring within the site.</p> <p>Showrooms 1 space per 500m² of the internal/external display area for customers.</p> <p>0.5 space per member of staff.</p> <p>Provision for the parking of 2 cycles per 500m² gross floor area or per outlet. Whichever is the greater.</p>
Garages	B1	<p>Sufficient operational parking and area for manoeuvring within the site.</p> <p>3 spaces per service bay plus 1 space per employee.</p> <p>Provision for the parking of 2 cycles per 500m² gross floor area or per unit if smaller.</p>	<p>Sufficient operational parking and area for manoeuvring within the site.</p> <p>2 spaces per service bay plus 0.75 space per employee.</p> <p>Provision for the parking of 2 cycles per 500m² gross floor area or per unit if smaller.</p>
Tyre and Exhaust Centres	B1	<p>Sufficient operational parking and area for manoeuvring within the site.</p> <p>3 space per bay.</p> <p>1 space per member of staff.</p> <p>1 space per 30m² retail floor space for accessory sales.</p> <p>Provision for the parking of 2 cycles per 500m² gross floor area or per unit if smaller.</p>	<p>Sufficient operational parking and area for manoeuvring within the site.</p> <p>2 spaces per bay.</p> <p>0.75 space per member of staff.</p> <p>1 space per 300m² retail floor space for accessory sales.</p> <p>Provision for the parking of 2 cycles per 500m² gross floor area or per unit if smaller.</p>

LAND USE	USE CLASS	PARKING REQUIREMENTS	
		Non Central Areas	Central Areas
PLACES OF ASSEMBLY Places of Worship	D1	Sufficient operational parking and area for manoeuvring within the site. 1 space per 6 seats. Provision for the parking of 2 cycles per 150m ² gross floor area.	Sufficient operational parking and area for manoeuvring within the site. Provision for the parking of 2 cycles per 150m ² gross floor area.
Public Halls	D1	Sufficient operational parking and area for manoeuvring within the site. 1 space per 6 seats. 1 space per 3 members of staff. Provision for the parking of 2 cycles per 150m ² gross floor area.	Sufficient operational parking and area for manoeuvring within the site. 1 space per 25 seats. 1 space per 3 members of staff. Provision for the parking of 2 cycles per 150m ² gross floor area.
Libraries/ Art Galleries	D1	Sufficient operational parking and area for manoeuvring within the site. 1 space per 2 staff. 1 space per 35m ² public floor area for visitors. Provision for the parking of 2 cycles per 150m ² gross floor area.	Sufficient operational parking and area for manoeuvring within the site. 1 space per 20 staff. 1 space per 350m ² public floor area for visitors. Provision for the parking of 2 cycles per 150m ² gross floor area.
Community Centre	D2	Sufficient operational parking and area for manoeuvring within the site. 1 space per 10m ² public floor area. Minimum of 4 spaces. Provision for the parking of 2 cycles per 150m ² gross floor area.	Sufficient operational parking and area for manoeuvring within the site. 1 space per 100m ² public floor area. Provision for the parking of 2 cycles per 150m ² gross floor area.
SPORTS AND LEISURE Cinemas	D2	Sufficient operational parking and area for manoeuvring within the site. 3 spaces per 10 seats. 1 space per 3 staff. Provision for the parking of 2 cycles per 150m ² gross floor area.	Sufficient operational parking and area for manoeuvring within the site. 3 spaces per 100 seats. 1 space per 30 staff. Provision for the parking of 2 cycles per 150m ² gross floor area.

LAND USE	USE CLASS	PARKING REQUIREMENTS	
		Non Central Areas	Central Areas
Bingo Halls	D2	<p>Sufficient operational parking and area for manoeuvring within the site.</p> <p>1 space per 10 seats – Patrons.</p> <p>1 space per 3 staff.</p> <p>Provision for the parking of 2 cycles per 150m² gross floor area.</p>	<p>Sufficient operational parking and area for manoeuvring within the site.</p> <p>1 space per 100 seats – Patrons.</p> <p>1 space per 30 staff.</p> <p>Provision for the parking of 2 cycles per 150m² gross floor area.</p>
Sports Centres		<p>Sufficient operational parking and area for manoeuvring within the site.</p> <p>1 coach space (minimum).</p> <p>Car parking to be based on assessment of area for:- Competitive sports Non competitive sports Spectators bar, restaurants etc.</p> <p>Car parking will be applied on the basis of 4 spaces per 10 patrons for sport users.</p> <p>1 space per 3.5 spectators.</p> <p>Appropriate standard for bar/restaurant facilities.</p> <p>1 space per 2 members of staff.</p> <p>Provision for the parking of 2 cycles per 200m² gross floor area.</p>	<p>Sufficient operational parking and area for manoeuvring within the site.</p> <p>Car parking to be based on assessment of area for:- Competitive sports Non competitive sports Spectators bar, restaurants etc</p> <p>Car parking will be applied on the basis of 4 spaces per 100 patrons for sport users.</p> <p>1 space per 35 spectators.</p> <p>Appropriate standard for bar/restaurant facilities.</p> <p>1 space per 20 members of staff.</p> <p>Provision for the parking of 2 cycles per 200m² gross floor area.</p>
Indoor/ Outdoor Stadia including Football Stadia		<p>Sufficient operational parking and area for manoeuvring within the site.</p> <p>Staff 1 space per 2 members of staff.</p> <p>Players/Competitors - 1 space per 2 players.</p> <p>Spectators 1 space per 5 spectators. This requirement will be significantly reduced if supported by an overall strategy aimed to sustain alternative means of travel to the site such as public transport, walking and cycling.</p> <p>1 coach space per 500 spectators.</p> <p>Provision for the parking of 2 cycles per 250m² gross site area.</p>	<p>Sufficient operational parking and area for manoeuvring within the site.</p> <p>Staff - 1 space per 20 members of staff.</p> <p>Players/Competitors - 1 space per 2 players.</p> <p>Spectators 1 space per 50 spectators. This requirement will be significantly reduced if supported by an overall strategy aimed to sustain alternative means of travel to the site such as public transport, walking and cycling.</p> <p>1 coach space per 5000 spectators.</p> <p>Provision for the parking of 2 cycles per 250m² gross site area.</p>

LAND USE	USE CLASS	PARKING REQUIREMENTS	
		Non Central Areas	Central Areas
Golf Courses	D2	<p>Sufficient operational parking and area for manoeuvring within the site.</p> <p>Staff 1 space per 2 member of staff.</p> <p>Players - 3 spaces per hole.</p> <p>Bar and Restaurant to be assessed Separately.</p> <p>Provision for the parking of 2 cycles per 9 holes.</p>	<p>Sufficient operational parking and area for manoeuvring within the site.</p> <p>Provision to be considered on merit subsequent to discussion and agreement with the Local Authority.</p> <p>Provision for the parking of 2 cycles per 9 holes.</p>
Swimming Pools	D2	<p>Sufficient operational parking and area for manoeuvring within the site.</p> <p>Staff - 1 space per 2 members of staff.</p> <p>Patrons - 1 space per 10m² pool.</p> <p>Spectators - 1 space per 10 seats.</p> <p>Provision for the parking of 2 cycles per 20m² pool area.</p>	<p>Sufficient operational parking and area for manoeuvring within the site.</p> <p>Staff - 1 space per 20 members of staff.</p> <p>Patrons - 1 space per 100m² pool.</p> <p>Spectators - 1 space per 100 seats.</p> <p>Provision for the parking of 2 cycles per 20m² pool area.</p>
HEALTH FACILITIES			
Health Centres	D1	<p>Sufficient operational parking and area for manoeuvring within the site.</p> <p>5 spaces plus 4 spaces per practice (without pharmacy) plus 4 spaces per doctor.</p> <p>Provision for the parking of 2 cycles per doctor.</p>	<p>Sufficient operational parking and area for manoeuvring within the site.</p> <p>2 spaces per Doctor.</p> <p>Provision for the parking of 2 cycles per doctor.</p>
Health Centres (with Pharmacy)	D1	<p>Sufficient operational parking and area for manoeuvring within the site.</p> <p>5 spaces plus 4 spaces per practice plus 4 spaces per doctor.</p> <p>Provision for the parking of 2 cycles per doctor.</p>	<p>Sufficient operational parking and area for manoeuvring within the site.</p> <p>2 spaces per Doctor.</p> <p>Provision for the parking of 2 cycles per doctor.</p>
Surgeries (e.g. dentist, chiropodist, doctor)	D1	<p>Sufficient operational parking and area for manoeuvring within the site.</p> <p>4 spaces per practitioner (visitors).</p> <p>1 space per 2 other members of staff normally present.</p> <p>Provision for the parking of 2 cycles per practitioner.</p>	<p>Sufficient operational parking and area for manoeuvring within the site.</p> <p>Provision for the parking of 2 cycles per practitioner.</p>

LAND USE	USE CLASS	PARKING REQUIREMENTS	
		Non Central Areas	Central Areas
Specialist Clinics	D1	<p>Sufficient operational parking and area for manoeuvring within the site.</p> <p>1 space per practitioner/consultant, (physio, homeopathy etc).</p> <p>2 spaces per practitioner/consultant (visitors).</p> <p>1 space per 2 other staff normally present.</p> <p>Provision for the parking of 2 cycles per practitioner.</p>	<p>Sufficient operational parking and area for manoeuvring within the site.</p> <p>1 space per practitioner/consultant, (physio, homeopathy etc).</p> <p>Provision for the parking of 2 cycles per practitioner.</p>
Hospitals	C2	<p>Sufficient operational parking and area for manoeuvring within the site.</p> <p>0.4 space per bed (staff).</p> <p>0.4 spaces per bed (visitors).</p> <p>3 spaces per consulting room (out patients).</p> <p>1 parking space per residential staff.</p> <p>Provision for the parking of 2 cycles per 30 bed spaces.</p>	<p>Sufficient operational parking and area for manoeuvring within the site.</p> <p>Town centre development will be likely to create a demand for parking levels of a similar order which may not be satisfied by the existing public car parking. However, the availability of existing off street car parking will be taken into account.</p> <p>Parking provision will be considered on merit. However, the Local Authority may require that such car parking provision as is required must be under LA control or that this provision could be located away from the site as part of the general central area car parking requirements. This would necessitate the applicant entering into an agreement with the LA to provide a commuted sum.</p> <p>Provision for the parking of 2 cycles per 30 bed spaces.</p>
EDUCATION Nursery Schools/ Crèches	D1	<p>Sufficient operational parking and area for manoeuvring within the site.</p> <p>1 space per 3 members of staff.</p> <p>1 space per 7 children.</p> <p>This latter requirement will be higher should staff start/finishing times be fixed.</p>	<p>Sufficient operational parking and area for manoeuvring within the site.</p> <p>1 space per 30 members of staff.</p> <p>1 space per 70 children.</p> <p>This latter requirement will be higher should staff start/finishing times be fixed.</p>

LAND USE	USE CLASS	PARKING REQUIREMENTS	
		Non Central Areas	Central Areas
Primary Schools		<p>Sufficient operational parking and area for manoeuvring within the site.</p> <p>0.8 space per full time teaching staff.</p> <p>1 space per 3 part time staff on duty at any one time.</p> <p>Provision for picking up and dropping off children. This requirement to be agreed in discussion with the Local Authority. In general it would be expected that approximately 20 spaces per form entry would be appropriate.</p> <p>This latter requirement must be satisfied either by:-</p> <p>a lay-by or circulation route on the school frontage or,</p> <p>an acceptably wide carriageway on the road fronting the site which is not a cul-de-sac.</p> <p>Provision for the parking of 6 cycles per form of entry.</p>	<p>Sufficient operational parking and area for manoeuvring within the site.</p> <p>1 space per 10 full time teaching staff.</p> <p>1 space per 3 part time staff on duty at any one time.</p> <p>Provision for picking up and dropping off children. This requirement to be agreed in discussion with the Local Authority. In general it would be expected that approximately 2 spaces per form entry would be appropriate.</p> <p>This latter requirement must be satisfied either by:-</p> <p>a lay-by or circulation route on the school frontage or,</p> <p>an acceptably wide carriageway on the road fronting the site which is not a cul-de-sac.</p> <p>Provision for the parking of 6 cycles per form of entry.</p>
Secondary Schools	D1	<p>Sufficient operational parking and area for manoeuvring within the site.</p> <p>1 space per full time teaching staff.</p> <p>1 space per 3 part time staff on duty at any one time.</p> <p>4 visitor spaces.</p> <p>1 space per 10 students over 17.</p> <p>Provision for picking up and dropping off children. This requirement to be agreed in discussion with the Local Authority. In general it would be expected that approximately 5 spaces per form entry would be appropriate.</p> <p>Provision for the parking of 8 cycles per each form of entry.</p>	<p>Sufficient operational parking and area for manoeuvring within the site.</p> <p>1 space per 10 full time teaching staff.</p> <p>1 space per 3 part time staff on duty at any one time.</p> <p>2 visitor spaces.</p> <p>1 space per 100 students over 17.</p> <p>Provision for the parking of 8 cycles per each form of entry.</p>
It is essential that reversing and turning movements at all schools should be minimised.			
Colleges of Education	D1	<p>Sufficient operational parking and area for manoeuvring within the site.</p> <p>0.8 space per full time equivalent teaching staff.</p> <p>1 space per 2 other members of staff.</p> <p>1 space per 6 students.</p> <p>Provision for the parking of 4 cycles per 30 students.</p>	<p>Sufficient operational parking and area for manoeuvring within the site.</p> <p>1 space per 10 full time equivalent teaching staff.</p> <p>1 space per 20 other members of staff.</p> <p>1 space per 60 students.</p> <p>Provision for the parking of 4 cycles per 30 students.</p>

LAND USE	USE CLASS	PARKING REQUIREMENTS	
		Non Central Areas	Central Areas
Halls of Residence		<p>Sufficient operational parking and area for manoeuvring within the site.</p> <p>1 space per 4 residents.</p> <p>Provision for the parking of 6 cycles per 30 residents.</p>	<p>Sufficient operational parking and area for manoeuvring within the site.</p> <p>1 space per 40 residents.</p> <p>Provision for the parking of 6 cycles per 30 residents.</p>
<p>FOOD AND DRINK</p> <p>Public Houses /Clubs</p>	A3	<p>Sufficient operational parking and area for manoeuvring within the site.</p> <p>1 space per 5m² public floor area.</p> <p>Shared arrangements with adjacent retail or commercial developments will normally be accepted.</p> <p>Provision for the parking of 4 cycles per 60m² gross floor space.</p>	<p>Sufficient operational parking and area for manoeuvring within the site.</p> <p>1 space per 50m² public floor area.</p> <p>Shared arrangements with adjacent retail or commercial developments will normally be accepted.</p> <p>Provision for the parking of 4 cycles per 60m² gross floor space.</p>
Restaurants	A3	<p>Sufficient operational parking and area for manoeuvring within the site.</p> <p>1 space per 2 seats.</p> <p>1 space per 5m² public floor area for bar use.</p> <p>Provision for the parking of 4 cycles per 60m² gross floor space.</p> <p>Drive Thrus may have different Characteristics from the normal restaurant use insofar as the car park associated with developments of this type may, in fact, form part of the dining area.</p> <p>In addition it appears that the level of provision for this type of development is heavily dependent on the operator.</p> <p>Individual assessment should be made of developments of this type.</p>	<p>Sufficient operational parking and area for manoeuvring within the site.</p> <p>1 space per 20 seats.</p> <p>1 space per 50m² public floor area for bar use.</p> <p>Provision for the parking of 4 cycles per 60m² gross floor space.</p> <p>Drive Thrus may have different Characteristics from the normal restaurant use insofar as the car park associated with developments of this type may, in fact, form part of the dining area.</p> <p>In addition it appears that the level of provision for this type of development is heavily dependent on the operator.</p> <p>Individual assessment should be made of developments of this type.</p>
HOTELS	C1	<p>Sufficient operational parking and area for manoeuvring within the site.</p> <p>1 space per 2 bedrooms.</p> <p>1 space per 5m² public floor area.</p> <p>Categories in “Food and Drink” as appropriate.</p> <p>Provision for the parking of 2 cycles per 10 bedrooms.</p>	<p>Sufficient operational parking and area for manoeuvring within the site.</p> <p>1 space per 20 bedrooms.</p> <p>1 space per 50m² public floor area.</p> <p>Categories in “Food and Drink” as appropriate.</p> <p>Provision for the parking of 2 cycles per 10 bedrooms.</p>

CONTENTS

<i>SECTION</i>	<i>TITLE</i>	<i>PAGE</i>
8.1	<u>INTRODUCTION</u>	81
8.2	<u>DESIGN REQUIREMENTS</u>	81
8.3	<u>MEASURES</u>	82

8.0 TRAFFIC CALMING

8.1 Introduction

Traffic Calming is required to ensure a 32 kph (20 mph) average speed for Secondary Access and Residential Roads, in areas immediately outside schools, and at any other points in the road layout where children may especially be at risk. The objective is intended to be achieved by a combination of suitable features designed to physically reduce speed to create a 'calm' driving style. It should be stressed that, in terms of minimising accident potential, this objective will be best achieved by a combination of speed reduction and environmental measures which enhance the perception of such roads as 'living areas'.

In some situations it may be difficult to distinguish between a Primary Access road and Secondary Access roads. On large scale residential development where Primary Access roads (no direct access to dwellings) can be clearly identified, a design speed of 48 kph (30 mph) would be appropriate. A road will normally be considered residential if it provides direct access for dwellings. Developers shall ensure an average speed of 32 kph (20 mph) on residential roads by installing suitable speed restraint measures to physically restrict vehicle speeds.

8.2 Design Requirements

The type of traffic calming technique employed and the distance between successive measures will ultimately determine the speed of vehicles. The exception to this may be on shared surfaces where speeds above the design speed are unlikely to occur and traffic calming will not be necessary.

For a typical traffic calming layout see Sketch 8.2.1.

Guidance on the suitability of various traffic calming techniques for different categories of road is given in Appendix 8.1 and recommended maximum distances between adjacent traffic calming measures are given in Table 8.1. It is important that the initial layout should be discussed with the Engineer at an early stage so that the emergency services and other potential users can be consulted.

All traffic calming measures must conform to the current Department for Transport Regulations.

(i) Local Distributors and Primary Access

Whilst contemporary traffic calming techniques may not be appropriate on Local Distributor and Primary Access Roads they are permitted if the speed limit is 48 kph (30 mph) or below. Careful design will be required to ensure that excessive speeds are not encouraged. In particular, consideration should be given to avoiding long straight stretches of road and highway corridors that appear excessively wide.

(ii) Industrial Estates

Traffic calming may be necessary for commercial and industrial estate roads. (See Clause 6.3).

(iii) Existing Roads

If traffic calming involving the introduction of narrower lane widths is installed on existing roads as part of any development it may be necessary to strengthen the existing carriageway in the vicinity of the traffic calming feature. The Engineer should be consulted at an early stage whilst considering the introduction of such measures on existing roads. Such proposals are likely to necessitate a Section 278 Agreement (See Clause 3.4).

TABLE 8.1

ROAD TYPE	HUMPS	SPEED CUSHIONS	THUMPS	HORIZONTAL DEFLECTIONS
Local Distributor Road	100m	70m	50m	80m
Primary Access Road	100m	70m	50m	80m
Secondary Access Road	40m	40m	N/A	40m
Residential Roads	40m	40m	N/A	40m

Note: A 'Thump' is a road hump formed from thermoplastic or similar material. They should only be used on existing roads, with the agreement of the Engineer (see Traffic Advisory Leaflet 7/96 for further information)

8.3 MEASURES

Listed below are definitions of the main traffic calming measures:-

(i) Gateway Feature

A gateway at the start of a 'traffic calmed' area alerts drivers to the fact that they are entering a residential area where the needs of pedestrians and cyclists take precedence over the free flow of vehicles. Features which contrast with the surroundings - such as signs, fences, landscaping, narrowings, vertical changes, coloured surfacing and islands - create a visual impact which encourages drivers to take extra care.

(ii) Vertical Shifts in the Carriageway

Whilst it is recognised that vertical shifts in the carriageway are the most effective form of speed restraint, developers should ensure that over reliance on such features is avoided. Vertical shifts involve raising the level of a portion of the carriageway examples include sinusoidal humps, round top humps, flat top humps (speed tables), speed cushions and plateaux. These features are likely to have adverse implications in respect to maintenance, signing and access for emergency services and winter maintenance vehicles. In the case of roads which are, or may become, bus routes the only

permissible vertical shift in the carriageway will be 65 mm high speed cushions (see Sketch 8.2.2) although this is not the preferred form of traffic calming on such routes.

Note 1: If the Developer proposes to use any vertical shifts in the carriageway for traffic calming cyclists must be considered in the detailed design. Either a cycle friendly hump must be used or provision must be made for cyclists to bypass the vertical shift.

Note 2: It is imperative that where flat top humps and plateaux extend over the whole of the carriageway the road and the footway are clearly delineated by tactile paving, or another measure so as to ensure that people with a visual handicap are aware they are entering the road. (See Sketches 8.2.2 and 8.3.1 to 8.3.3).

Note 3: It is not permitted to construct any vertical shift in the carriageway on or under any bridge or other structure or within 25 metres of such a structure.

(iii) Horizontal Shifts in the Carriageway

Carriageway constrictions and lateral shifts in the carriageway are effective means of reducing traffic speeds. These measures will be suitable for all residential roads and should be reinforced by supporting environmental and safety measures. However, it is recognised that difficulties can occur in layouts with direct vehicular access.

The provision of some form of cycle bypass should be considered where it is planned to use horizontal shifts in the carriageway (see sketch 8.3.4).

(iv) Carriageway Constrictions

These involve a localised narrowing of a carriageway to give one way priority movement or at least require vehicles to slow down radically to pass one another. They are usually combined with measures such as footway/footpath extensions, pedestrian refuges, planting or street furniture (see sketch 8.3.4).

(v) Priority Amendments

For junctions between roads of Category 3 (Secondary Access Road) and below it is acceptable to give priority to the minor road as a speed restraint measure. Although the visibility splay standards given in Appendix 5.2 will apply, care should be taken not to provide excessive visibility splays from both the major and minor roads as this may encourage higher speeds through junctions. Where one way streets are provided additional speed restraint measures will usually be required to prevent higher speeds.

Priority amendments can also be used in conjunction with carriageway narrowing to create a single lane with priority in one direction as a speed reduction measure. Table 8.2 gives the minimum constricted width for priority in one direction with single file traffic.

TABLE 8.2

ROAD TYPE	MINIMUM WIDTH WITH CYCLE BYPASS OR ADJACENT CYCLE TRACK	MINIMUM WIDTH WITHOUT CYCLE BYPASS
Local Distributor	3.65 m	3.65 m
Primary Access Road	3.25 m	3.5 m
Secondary Access Road	3.25 m	3.5 m
Residential Road	3.25 m	3.5 m
Shared Surface	3.25 m	N/A

(iv) Roundabouts

The Engineer should be consulted before a roundabout is introduced to any scheme as other speed reduction measures will normally be more appropriate. Speed reduction is achieved by creating a lateral shift in the carriageway and priority to traffic from off-side. Separate provision for pedestrians and cyclists will usually be required (additional speed reduction measures may be required in areas intended to restrict speeds to 32 kph (20 mph)).

(vii) Reduced Corner Radii

These are only effective in slowing turning movements at junctions offering greater safety for pedestrians and cyclists. Overrun areas, constructed by slightly raising the surface within the limits specified in The Highway (Traffic Calming) Regulations, can be provided to allow larger vehicles access. (See sketch 8.3.5).

(viii) Speeding/Red Light Camera

These should not be required if the road layout has been suitably designed, however it is conceivable that in some situations it may be necessary to provide a site for a camera. They reduce speed through heightened awareness of the speed limit local to the camera.

KEY TO APPENDIX 8.1

- ✓ traffic calming measures which could be considered for roads classified using the road hierarchy.
- (✓) only if the speed limit is 48 kph (30 mph) or less and the scheme is approved by the Engineer.
- x traffic calming measures which are not suitable for roads classified using the road hierarchy.

APPENDIX 8.1

<div style="text-align: center;">TYPE OF ROAD</div> <div style="text-align: left;">FEATURE</div>	Local Distributor	Primary Access Road	Secondary Access Road	Residential Roads	Shared Surface
Traffic Management					
Overruns	✓	✓	✓	✓	X
Reduce Corner Radii	✓	✓	✓	✓	X
Road Markings	✓	✓	✓	✓	✓
Gateways	✓	✓	✓	✓	✓
Priority Amendments	X	X	✓	✓	✓
Road Signs	✓	✓	✓	✓	✓
Traffic Signals and Pelicans	✓	X	X	X	X
Pedestrian Refuges and Splitter Islands	✓	✓	✓	✓	X
Road Closures	X	X	✓	✓	X
Vertical Traffic Calming					
Sinusoidal Hump	(✓)	(✓)	✓	✓	✓
Round Top Hump	(✓)	(✓)	✓	✓	✓
Flat Topped Hump	(✓)	(✓)	✓	✓	✓
Extended Flat Topped Hump	(✓)	(✓)	✓	✓	X
Asymmetrical Flat Top	(✓)	(✓)	✓	✓	X
Speed Cushions	✓	✓	✓	✓	X
Rumble Strip	✓	✓	✓	✓	✓
Horizontal Traffic Calming					
Build Outs	✓	✓	✓	✓	✓
Pinch Points	✓	✓	✓	✓	✓
Chicanes	✓	✓	✓	✓	✓
Roundabouts	✓	✓	✓	✓	X
New Technology					
Red Light/Speed Cameras	✓	✓	X	X	X
Secret Signs	✓	✓	X	X	X
Variable Speed Limits	✓	✓	X	X	X
Other Measures					
Optical Width	✓	✓	✓	✓	✓
Narrow Carriageways	✓	✓	✓	✓	✓
Occasional Strips	X	✓	✓	✓	✓
Surface Changes-Type/Colour/Location	✓	✓	✓	✓	✓
Footway Extensions	X	✓	✓	✓	✓
Planting Greenery	X	X	✓	✓	✓
Street Furniture/Lighting	✓	✓	✓	✓	✓
Regulations	✓	✓	✓	✓	✓

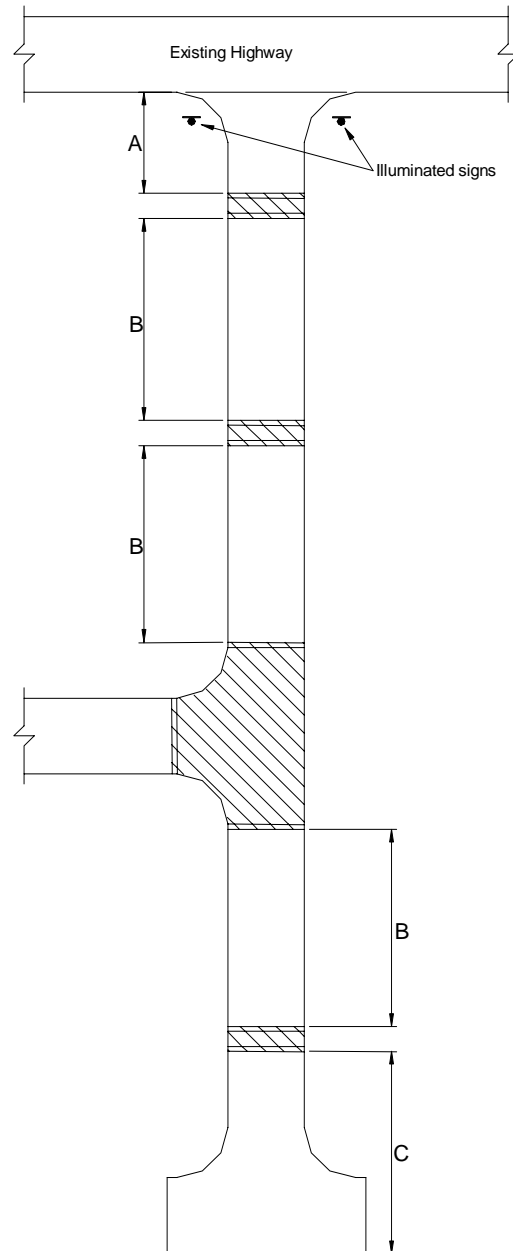

Notes

- A Not less than 8m but no more than 40m
 - B Not less than 20m but no more than 150m (see guide for unrestrained road lengths)
 - C Not greater than 40m from the end of a cul-de-sac.
- 1 Individual roads less than 100m in length do not require traffic calming unless it is part of an overall scheme.
 - 2 Appropriate illuminated signs must be erected at the beginning of the scheme. For the depiction of traffic calming a single sign is required, whereas signs depicting a 20 mph zone should be on both sides of the road.

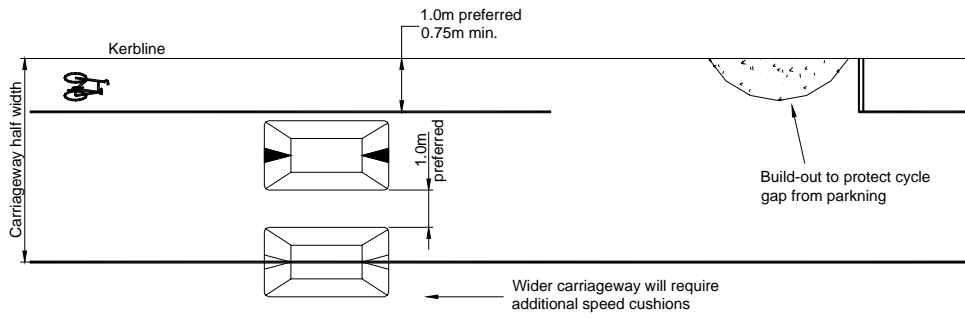

Typical Layout

1600mm - 1700mm for bus route;
up to 2000mm elsewhere

Within chicanes narrower widths
may be appropriate

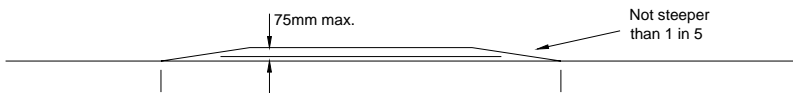
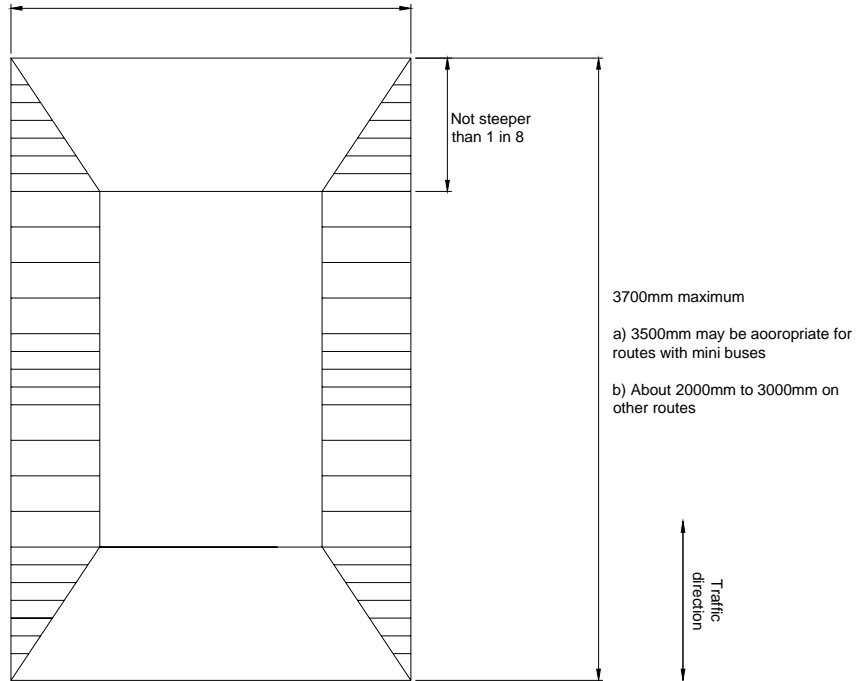

DETAIL

Notes

1. Narrower cushions should be 65mm high.

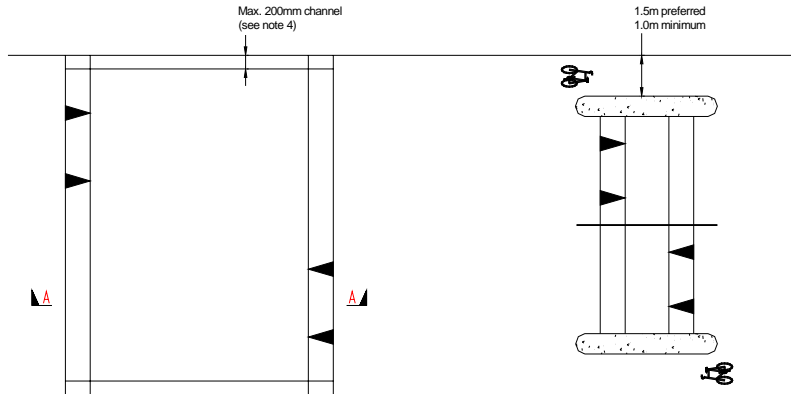

Plan

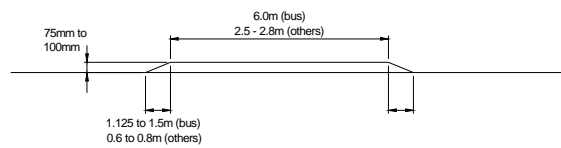

Section A-A

Notes

1. Road humps shall comply with The Highways (road humps) Regulations 1996.
2. If flat top humps are provided on a bus route the plateau length shall be 6.0m and the ramp gradient shall be 1 in 15.
3. Road markings and signing of road humps shall be provided and located as prescribed in The Traffic Signs Regulations and General Directions 1994, The Traffic Signs Manual and The Highways (road humps) Regulations 1996 or any subsequent regulations superseding these.
4. If a continuous channel is provided it should be a maximum of 200mm wide. Side ramps should be between 150mm and 250mm wide. If cyclists are likely to use the road provision of cycle bypass should be considered.

ROUND TOP HUMP - LONGITUDINAL SECTION

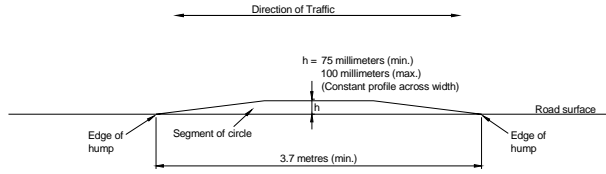

Notes

This hump normally extends across the road from kerb to kerb. A permitted variant is shown in the diagram below.

ROUND TOP HUMP (TAPERED SIDED) - TRANSVERSE SECTION

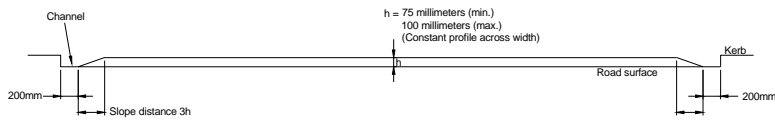

ROUND TOP HUMP (TAPERED SIDED) - PLAN VIEW

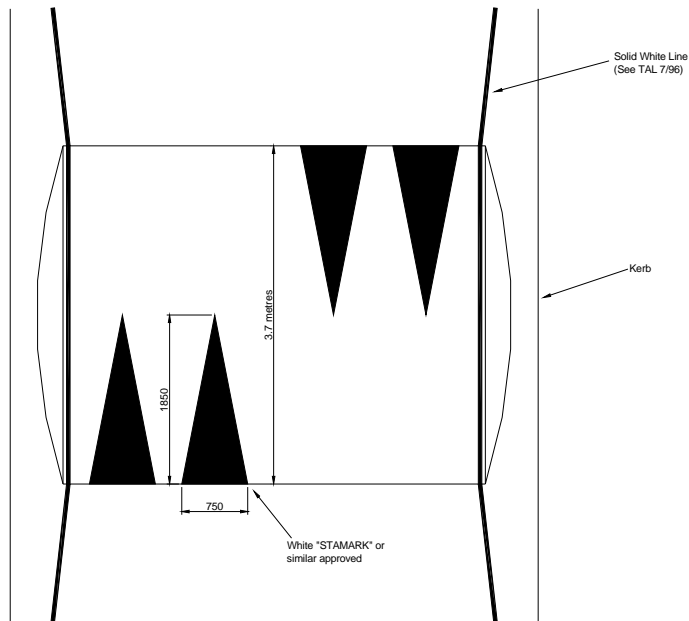

Notes for Sketch 8.3.4

- (a) The approaches to and exits from bypasses of road narrowing should ideally be protected from parked vehicles within 20m. Where parked vehicles would otherwise be anticipated to block the gap for cyclists, this can be avoided by use of build-outs, parking restrictions or a mandatory cycle lane. If a mandatory cycle lane is not used than an advisory cycle lane is recommended.

Priority System

- (b) Provide alternating priority for vehicles where a number of narrowing are proposed, except on a gradient when priority may be given to the uphill direction.
- (c) Ensure that the gap provided for cyclists allows for growth of any adjacent vegetation.
- (d) For details of speed cushions see Sketch 8.2.2.

Central Island

- (e) It is recommended that central islands only be used to cater for particular pedestrian crossing movements.
- (f) Where the design speed is less than 40 kph (25 mph) and the vehicle flow is expected to be light then a maximum carriageway width of 3.0m is recommended. Where the design speed is greater than 40kph (25 mph) and/or where wide vehicles are expected to be common then the minimum carriageway width shall be 4.5m around the central island.
- (g) The speed reducing effect of traffic islands is usually only slight. Other features such as speed cushions and road humps should be considered in order to reduce speed.
- (h) Where a refuge is provided on a hill, narrowing the gap downhill can assist uphill cyclists by increasing the width available.

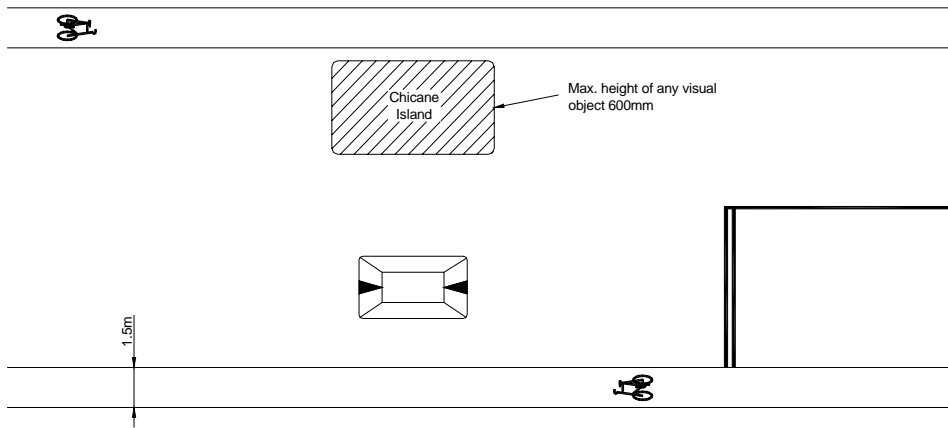

Priority System - Single Chicane

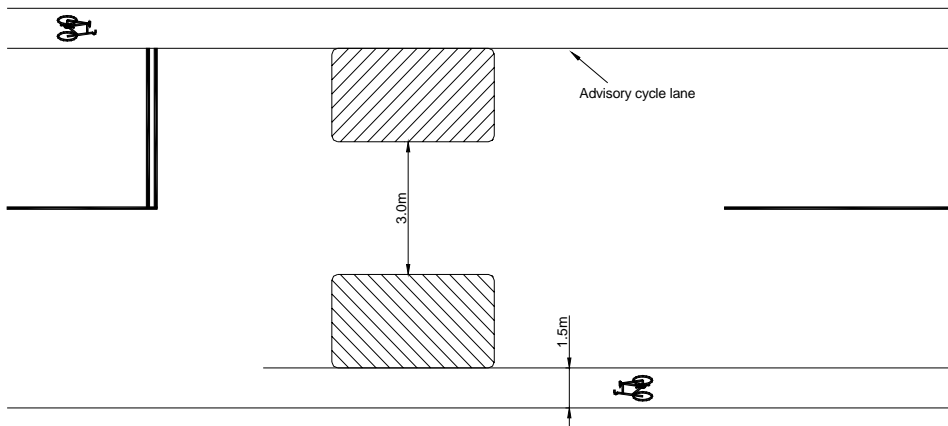

Priority System - Pinch Point

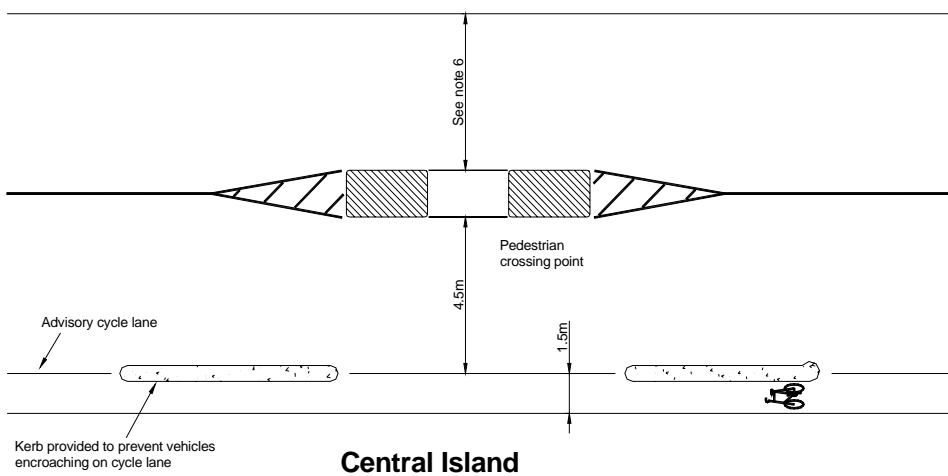

Central Island

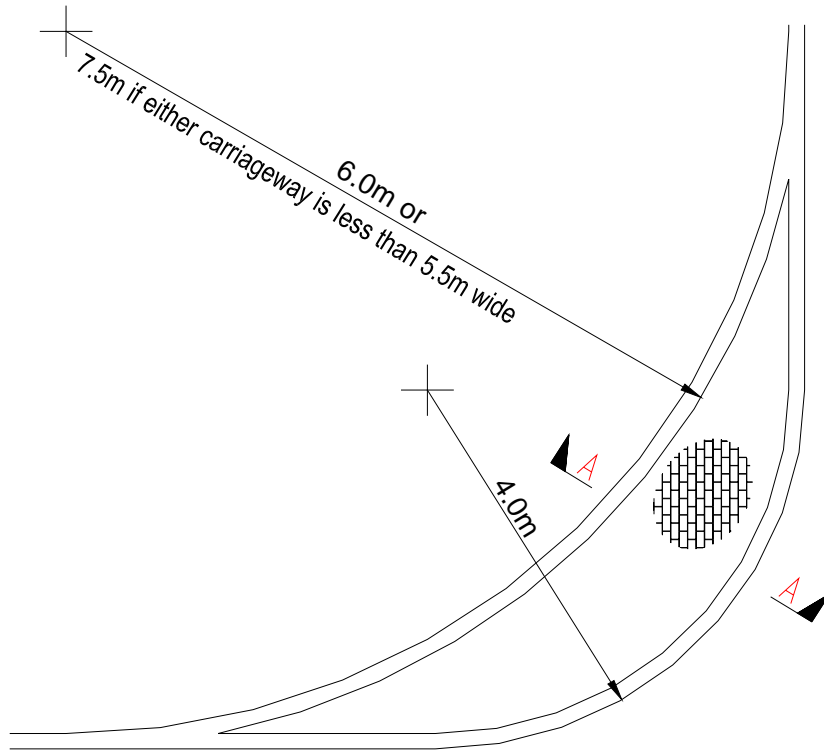

Plan

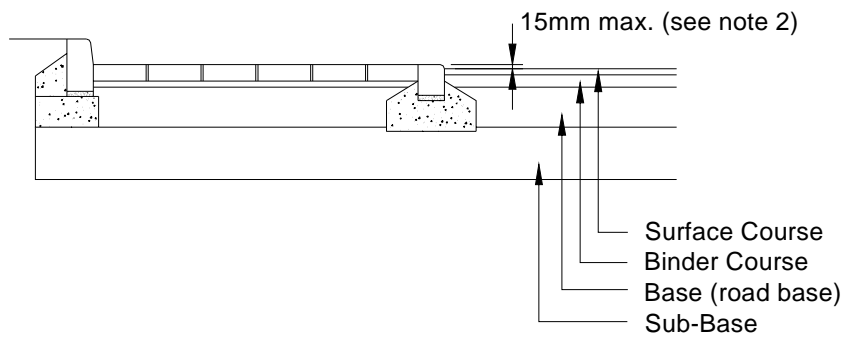

Section A-A

Notes

1. Maximum slope of overrun area to be 1 in 4.
2. No vertical face to be greater than 6mm.

CONTENTS

<i>CLAUSE</i>	<i>TITLE</i>	<i>PAGE</i>
9.1	<u>INTRODUCTION</u>	94
9.2	<u>DEFINITION OF A CYCLE TRACK</u>	94
9.3	<u>LAYOUT</u>	94
9.4	<u>SURFACE FINISH</u>	94
9.5	<u>ROAD CROSSINGS</u>	94
9.6	<u>DRAINAGE</u>	95
9.7	<u>EMERGENCY ACCESS</u>	95
9.8	<u>MEASURES TO PREVENT ABUSE BY MOTOR VEHICLES</u>	95
9.9	<u>CYCLE PARKING</u>	95
9.10	<u>DESIGN STANDARDS</u>	96
9.11	<u>GENERAL</u>	98

9.0 CYCLING FACILITIES

9.1 INTRODUCTION

The Developer shall liaise with the Engineer to establish the requirements in regard to the provision of cycling infrastructure and links into the existing cycling network.

9.2 DEFINITION OF A CYCLE TRACK

“Cycle track” means a way independent of an existing highway, over which the public have a right of way on pedal cycles with or without a right of way on foot (as defined in section 329(1) of the Highways Act 1980, and as amended by Section 1(1) of the Cycle Tracks Act 1984)

9.3 LAYOUT

Pedestrian facilities should normally be provided alongside cycle tracks and segregation between cyclists and pedestrians should preferably be achieved by a level difference and surface colour differentiation as shown in Sketch 9.3.1. However, the use of a 150 mm wide white line together with surface colour differentiation may be acceptable in locations to be agreed by the Engineer.

Tactile paving and markings are to be provided in accordance with current DETR guidance.

9.4 SURFACE FINISH

The cycle track surface finish is to be red (for colour quality see Clause 10.7.7).

Segregation by level difference should always be achieved in urban areas and where there is likely to be substantial use by pedestrians and/or cyclists, or if the route is commonly used by elderly or visually handicapped persons. The cycle track is to be set at the lower level and shall have white thermoplastic cycle markings at all entry/exit points and at regular intervals along its length.

9.5 ROAD CROSSINGS

Careful consideration should be given to the type of crossing required. Factors such as traffic flows, likely vehicle speeds and intervisibility between road users and cyclists will influence this decision. The following table of speed/flow criteria for the carriageway to be crossed provides guidance in helping to determine the appropriate form of crossing. Whilst these criteria are important, other aspects of a crossing should be considered and this should only be done by using the LTN 1/95 methodology. The need for measures to reduce vehicle speeds on the main road approaches should be addressed if necessary. The figures in Table 9.1 are to be treated as a guide only.

There may be a need to introduce measures to reduce the speed of cyclists, such as the speed reduction barriers shown in Sketch 9.5.1, prior to crossing a road or footpath/footway.

TABLE 9.1

CROSSING FACILITY	VEHICLE SPEED		VEHICLE FLOW "2 WAY vpd"
	kph	mph	
Cycle track priority (Sketch 9.11.1)	<48	(30)	<4000
Cycle give way to cars (Sketch 9.11.3)	<80	(50)	<8000
Cycle give way to cars with central refuge (Sketch 9.11.4)	<80	(50)	<8000
Signal Control	<80	(50)	<8000

The Engineer should be consulted before any type of crossing is decided upon.

9.6 DRAINAGE

Provision of any cycling facility or footpath should not have any adverse affect in terms of surface water runoff onto adjacent land. As a guide positive drainage comprising of gullies and pipe work will not be required for a cycle track. If some form of positive drainage is required all gullies must be located off the riding surface of the cycle track. It may be necessary to provide some form of cut off drainage to contain surface water runoff. The Developer should discuss requirements for drainage with the Engineer at an early stage.

9.7 EMERGENCY ACCESS

In some cases it may be desirable to use the corridor created for a cycle track as an emergency access. The Developer should discuss the layout of the proposed development, including the location of any necessary emergency accesses, with the Engineer at an early stage so that, if necessary, the cycle track can be designed to accommodate emergency vehicles.

9.8 MEASURES TO PREVENT ABUSE BY MOTOR VEHICLES

The developer shall provide physical measures to prevent motor vehicles gaining access to any cycle track. The Developer should have early discussions with the Engineer to ascertain physical measures which will be suitable in particular locations.

9.9 CYCLE PARKING

All cycle parking should be in accordance with Section 7.

9.10 DESIGN STANDARDS

The following standards shall apply:-

- (i) Cycle Tracks
 - (a) Minimum radius of curvature should be 15m.
 - (b) Minimum desirable sight line distance is 30m although in exceptional circumstances this may be varied at the discretion of the Engineer.
 - (c) Desirable crossfall 2.5% in sympathy with any direction of curvature. Crossfall may be more than 2.5% when superelevation is needed at tight bends.
 - (d) Gradients should be-3% maximum over unrestricted lengths
 - 5% maximum over lengths up to 100m
 - 7% maximum over lengths up to 30m
 - note -in exceptional circumstances gradients exceeding 7% are acceptable over shorter lengths.
 - (e) For a 2-way independent cycle route the width required is 3m.
 - (f) Minimum desirable lateral clearance 0.5m, desirable minimum headroom 2.7m.
 - (g) Visibility standards where cycle tracks cross roads shall be in accordance with Table 9.2. There shall be no relaxation of the 'y' distance. The 'x' distance should be 9m however in difficult circumstances it may be reduced to 4.5m providing an upright 'Give Way' sign (Diag. 602) is provided on the cycle track. Only in exceptional circumstances will an 'x' distance of less than 4.5m be allowed. In this case an upright 'Stop' sign (Diag 601.1) must be provided (note this will require DTLR approval which may be a lengthy procedure and will be at the Developer's expense). Further details are available in TD42/95. Early consultation with the Engineer is recommended.

TABLE 9.2

DESIGN SPEED OF ROAD		'y' DISTANCE (m)
kph	mph	
32 or less	(20)	33
40	(25)	45
50	(30)	70
60	(40)	90

(ii) Combined Cycle Tracks/Footpaths

- (a) The combined width shall be 3.6 metres (between restrains) comprising a 1.8m cycle track and 1.8 metre footpath. In exceptional circumstances the widths given in Table 9.3 may be considered by the Engineer. Further guidance on suitable widths for combined facilities is given in Local Transport Note: 2/86 "Shared use by Cyclists and Pedestrians".
- (b) Any planting adjacent to a cycle track should be designed not to cause punctures to pneumatic cycle tyres subsequent to trimming or windfall whilst still providing a substantial visual and physical barrier if required. Any planting should be designed so that at all times expected growth shall not overhang the cycle track. All landscape proposals should be in accordance with Section 13. The proposals shall be submitted to the Engineer for approval.

TABLE 9.3

TYPE OF SEGREGATION	CONSTRAINT	FOOTWAY/ FOOTPATH (m)	CYCLE TRACK (m)	VERGE (m)	TOTAL WIDTH (m)
KERB	None	1.5	1.5	-	3.0
	Bounded on Footway/Footpath Side	1.75	1.5	-	3.25
	Bounded on Cycle Track Side	1.5	1.75	-	3.25
	Bounded on Both Sides	1.75	1.75	-	3.5
RAILINGS	None	1.7	1.7	-	3.4
	Bounded on Footway/Footpath Side	1.95	1.7	-	3.65
	Bounded on Cycle Track Side	1.7	1.95	-	3.65
	Bounded on Both Sides	1.95	1.95	-	3.91
WHITE LINE	Open Site	1.2	1.3	-	2.5
	Walls, bushes etc on either side	1.2	1.5	-	2.7
	Carriageway on cycle track side	1.2	1.5	0.5	3.2

9.11 GENERAL

- (i) Construction Details are to comply with the requirements of Section 10.
- (ii) Street lighting is to be provided in accordance with Section 11 with additional lighting at intersections with other traffic routes. The scheme is to be submitted to the Engineer for approval.
- (iii) Traffic signs and road markings are to be provided and located as prescribed in The Traffic Signs Regulations and General Directions 1994 and the Traffic Signs Manual. The proposals are to be submitted to the Engineer for approval.
- (iv) The Developer shall seek advice from the Engineer in respect to the form of all crossings and junctions. See also sketches 9.11.1 to 9.11.4 and Clause 9.3.
- (v) Any proposals that require the construction of subways or retaining walls must be discussed with the Engineer and comply with 'The Technical Approval Procedure for Developers Structures' (see Clause 4.9).

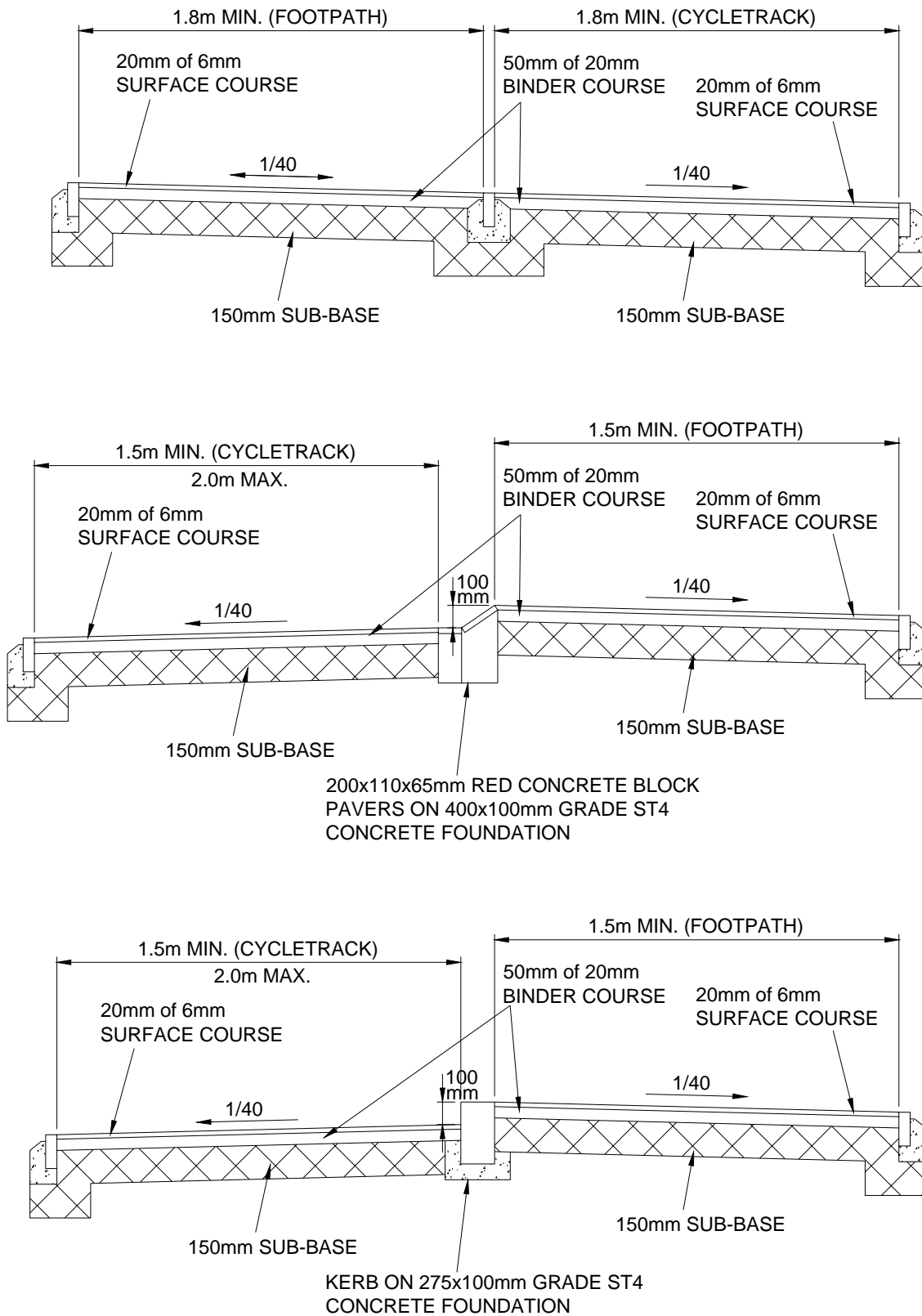

TYPICAL CYCLEWAY DETAIL

Sketch No 9.3.1

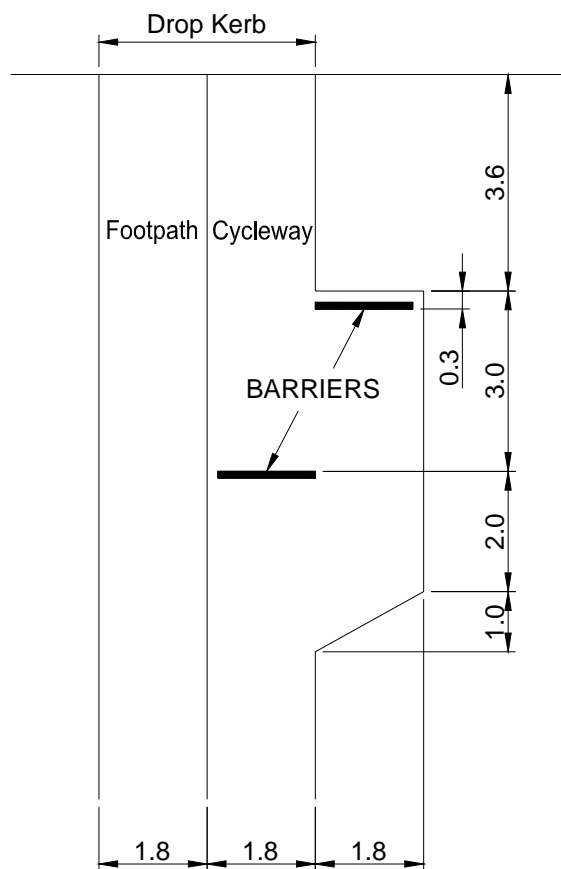
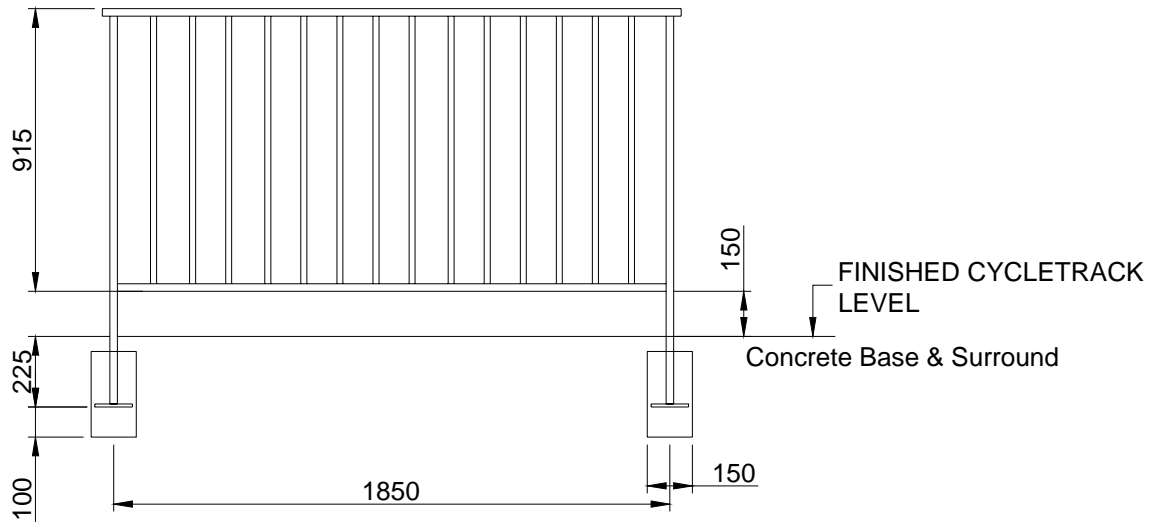

Cycle Track Priority Crossing

Notes for Sketch 9.11.1

- (a) A cycle track priority road crossing should only be used for crossing single carriageway roads where the anticipated vehicle flow is less than 4000 vehicles per day and vehicle speed is physically restricted to less than 48 kph (30 mph).
- (b) The flat top road hump should be constructed in a contrasting colour or material to give prominence to the traffic calming feature. The road hump design and location must comply with the Road Hump Regulations, including signing requirements.
- (c) This facility will require reasonable visibility between the cycle track and the carriageway dependent upon the circumstances at a particular location. Reasonable visibility will therefore be provided between the cycle track and the footway and thus it is unlikely that sign Diag No.963.1 will be necessary.
- (d) The maximum permitted height of a road hump is 100mm, and kerbs are generally 125mm. Providing a level crossing may necessitate dropping the kerb line slightly.
- (e) This detail shows an arrangement to give cyclists priority to cross a minor road. In choosing such an arrangement developers should be aware that this does not accord the same priority to pedestrians.
- (f) Diag No.950 is shown on this drawing to illustrate the range of circumstances in which it can usually be employed. In practice, it will normally be sited at a greater distance from the feature than it has been possible to show in the drawing. Advice is given in Chapter 4 of the Traffic Signs Manual. Note that the distance on plate Diag No.572 should be in yards.
- (g) Diag No. 7014 'Changed Priorities Ahead' may be used on the approaches to the crossing when relevant.
- (h) Tactile paving and markings are to be provided in accordance with current DTLR guidance.
- (i) Traffic signs and road markings are to be to the satisfaction of the Engineer and are to be provided and located as prescribed in the Traffic Signs Regulations and General Directions 1994 and the Traffic Signs Manual or any subsequent superseding regulations.

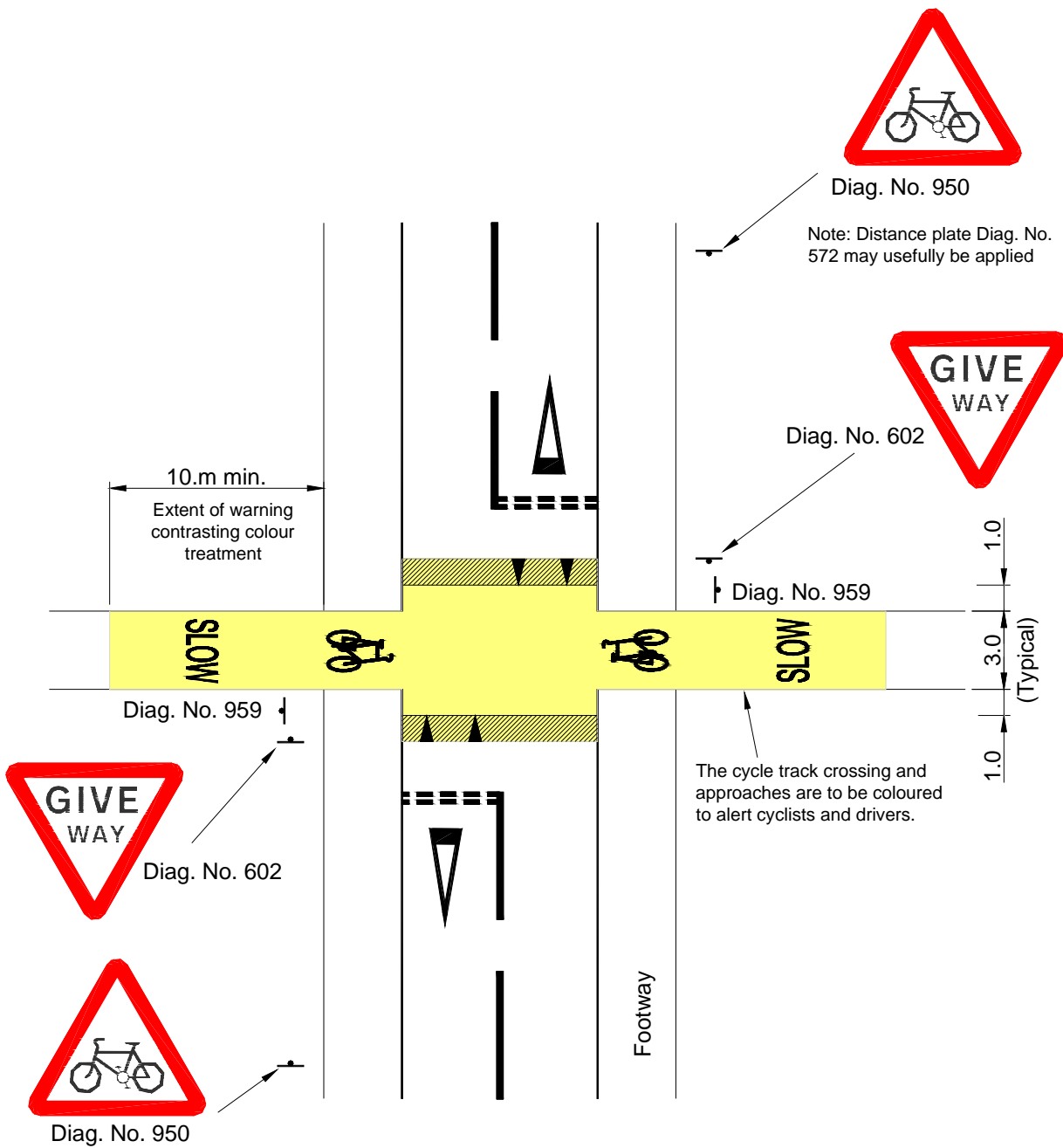

Note: Restrict roadside parking on approaches to ensure visibility.

Cycle Track Priority Crossing “Bending Out” at Minor Road

Notes for Sketch 9.11.2

- (a) Cycle track priority road crossings should only be used where anticipated vehicle flows are less than 4000 vehicles per day and vehicle speed is physically restrained to less than 48kph (30 mph).
- (b) The flat top road hump should be constructed in a contrasting colour or material to give prominence to the traffic calming feature. The road hump design and location must comply with the Road Hump Regulations, including signing requirements.
- (c) The maximum permitted height of a road hump is 100mm, and kerbs are generally 125mm. Providing a level crossing may necessitate dropping the kerb line slightly.
- (d) If visibility between the footway and cycle track is restricted, sign Diag No. 963.1 may be necessary.
- (e) It is important for safety that the “bend out” is designed so as to provide the cyclist with a straight approach to the crossing. The cycle path should not be deflected through an angle greater than 45° and should not give the cyclist the feeling of a detour.
- (f) Advice on the siting of sign Diag No. 950 is given in Chapter 4 of the Traffic Signs Manual.
- (g) Diag No.7014 “Changed Priorities Ahead” may be used on the approaches to the crossing when relevant.
- (h) Where build-outs or flat top road humps are constructed the highway drainage requirements must be considered.
- (i) This detail shows an arrangement to give cyclists priority to cross a minor road. In choosing such an arrangement developers should be aware that this does not accord the same priority to pedestrians.
- (j) Tactile paving and markings are to be provided in accordance with current DTLR guidance.
- (k) Traffic signs and road markings are to be to the satisfaction of the Engineer and are to be provided and located as prescribed in the Traffic Signs Regulations and General Directions 1994 and the Traffic Signs Manual or any subsequent superseding regulations.

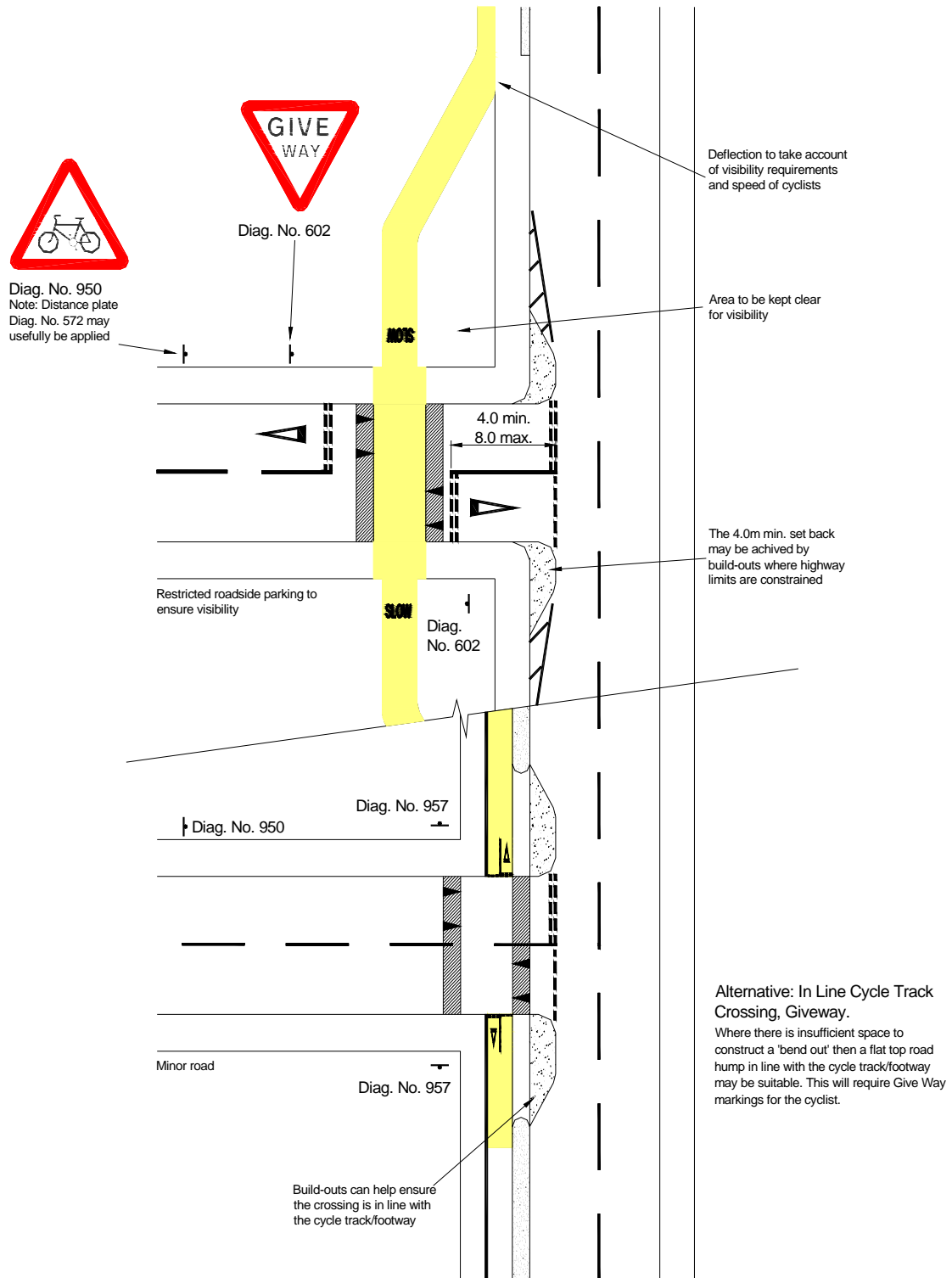

CYCLE TRACK CROSSING 'BENDING OUT' AT MINOR ROAD

Sketch No 9.11.2

Cycle Track Give Way Crossing

Notes for Sketch 9.11.3

- (a) Where anticipated traffic flows are less than 4000 vehicles per day on a single carriageway the cycle track priority crossing should be considered.
- (b) This detail is not suitable for anticipated vehicle flows greater than 6000 vehicles per day or where anticipated speeds are greater than 80kph (50 mph).
- (c) If visibility between the cycle track and the footway is inadequate and it is not possible to incorporate measures to improve visibility then traffic sign Diag No.963.1 may be necessary to advise pedestrians of a cycle track crossing. Unnecessary use of this will cause sign clutter.
- (d) Where visibility is poor it is preferable to use all the signs and markings available for the Give Way (Diag No.s 602, 1003 and 1023) for the cyclist rather than a barrier/chicane.
- (e) Diag No.950 is shown on this drawing to illustrate the range of circumstances in which it can usually be employed. Its location is diagrammatic only. Advice is given in Chapter 4 of the Traffic Signs Manual.
- (f) Where carriageway width permits, it may be advantageous to provide a central refuge. This will benefit both cyclist and pedestrian safety.
- (g) Tactile paving and markings are to be provided in accordance with current DTLR guidance.
- (h) Traffic signs and road markings are to be to the satisfaction of the Engineer and are to be provided and located as prescribed in the Traffic Signs Regulations and General Direction 1994 and the Traffic Signs Manual or any subsequent superseding regulations.

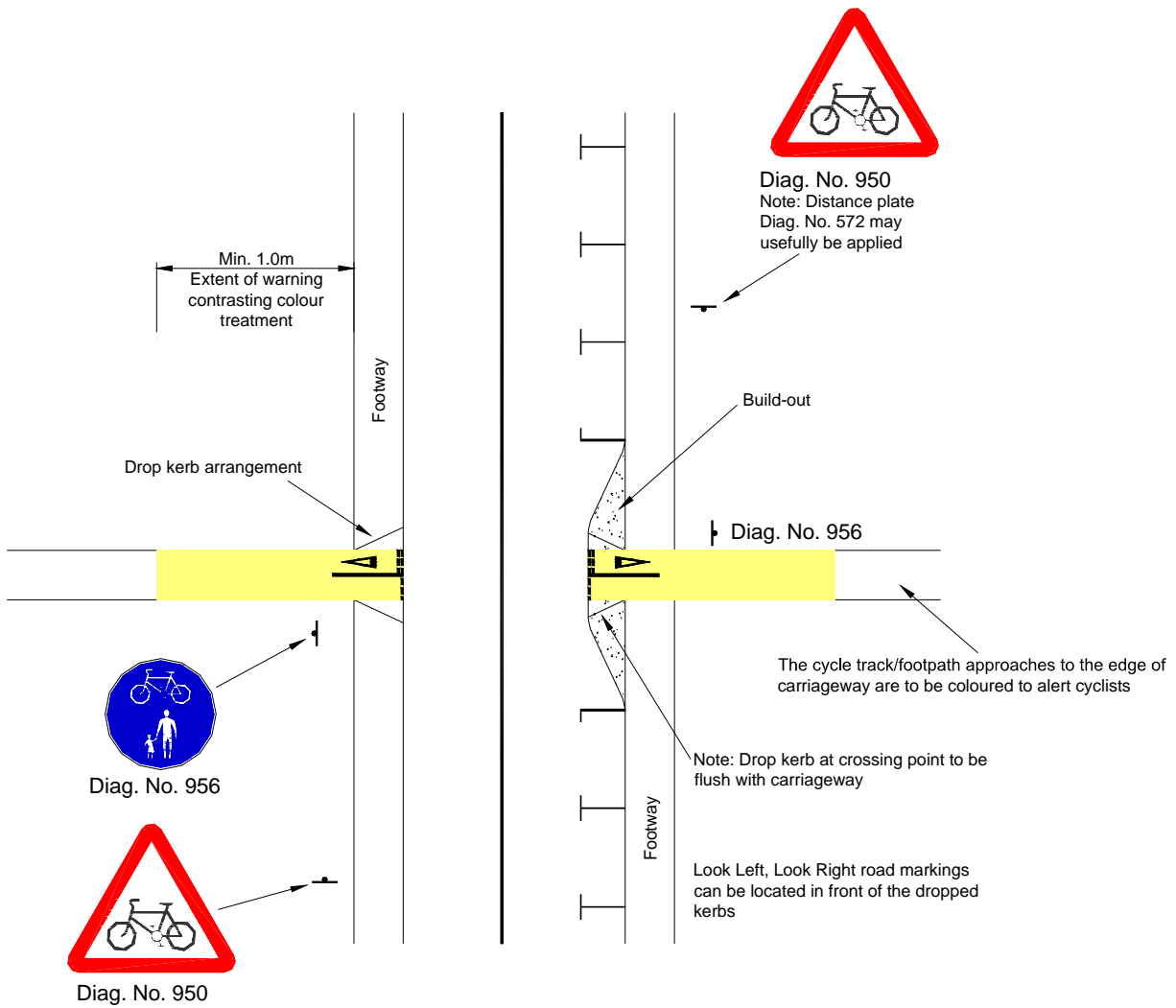

Cycle Track Crossing with Refuge Island

Notes for Sketch 9.11.4

- (a) In urban areas, this detail is suitable for all road categories up to and including Primary Access Roads. This detail may also be suitable for all single carriageway roads with anticipated traffic flows less than 8,000 vehicles per day.
- (b) If visibility between the cycle track and the footway is inadequate and it is not possible to incorporate measures to improve visibility then traffic sign Diag No.963.1 may be necessary to advise pedestrians of a cycle track crossing.
- (c) Where visibility is poor it may be preferable to use all the signs and markings available for the Give Way (Diag No.s 602,1003 and 1023) for the cyclist rather than a barrier/chicane.
- (d) Where the design speed is less than 40kph (25mph) and the anticipated vehicle flow is light then a maximum carriageway width of 3.0m is recommended. Where the design speed is greater than 40kph (25mph) and/or where wide vehicles are expected to be common then the minimum carriageway width shall be 4.5m around the central island.
- (e) Generally the crossing area within the refuge should have a longitudinal width between 3.0m and 4.0m (absolute minimum 2.5m) to accommodate groups of cyclists and should be flush with the adjacent carriageway.
- (f) Diag No.950 is shown on this sketch to illustrate the range of circumstances in which it can usefully be employed. Its location is diagrammatic only. Advice is given in Chapter 4 of the Traffic Signs Manual.
- (g) Where pedestrian flows on the footway are high it may be advantageous to bend out the footway (as shown), or provide a build-out (see Sketch 9.11.3). This will allow cyclists to wait at the Give Way line without impeding pedestrians. If this is not feasible then the Give Way lines can be placed at the back of the footway.
- (h) Segregation on the immediate approaches to the crossing may not be appropriate in all circumstances. Consideration may be given to the inclusion of Give Way lines within the refuge.
- (i) Tactile paving and markings are to be provided in accordance with current DTLR guidance.

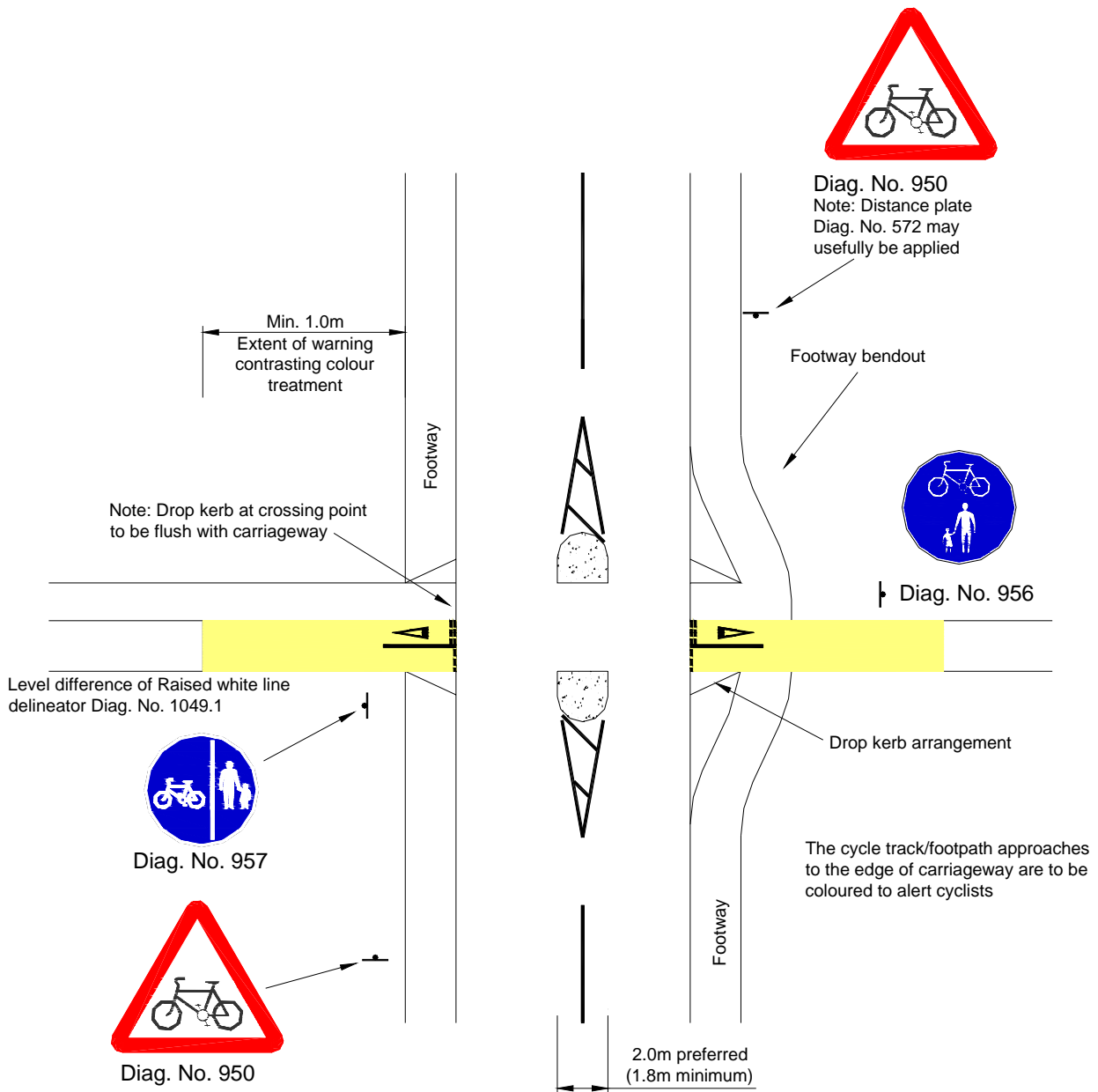

Access Barriers

Notes for Sketch 9.11.5

- (a) Bollards should be the first choice to discourage access by motor vehicles. If motorcycles subsequently become a nuisance then more restrictive forms of barrier should be considered.
- (b) Wheelchair users negotiating the access barrier may need to swing under the barriers when turning. The barriers on the wheelchair bypass should therefore comprise a single rail with a 700mm clearance to the ground. Fences/walls etc. adjoining the wheelchair bypass must meet it at one of the corners, and free space to a distance of 450mm outside these rails should be provided.
- (c) The barriers in the sketch are shown constructed in tubular steel.
- (d) All steelwork is to be provided with adequate corrosion protection to the satisfaction of the Engineer.
- (e) Consideration must be given to the visibility of bollards and barriers so that they do not cause a hazard to path users. The use of high visibility paints or signs may be necessary.

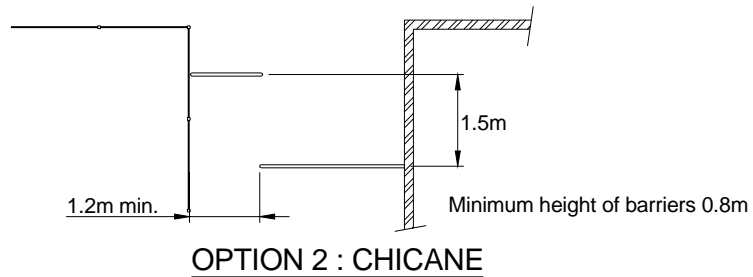
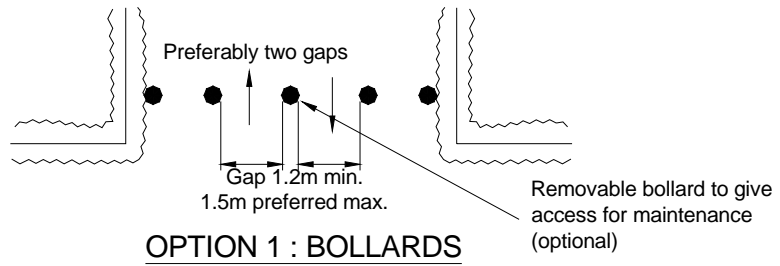

Height may be raised to 0.5m where scramble motor cycles are foreseen as a problem

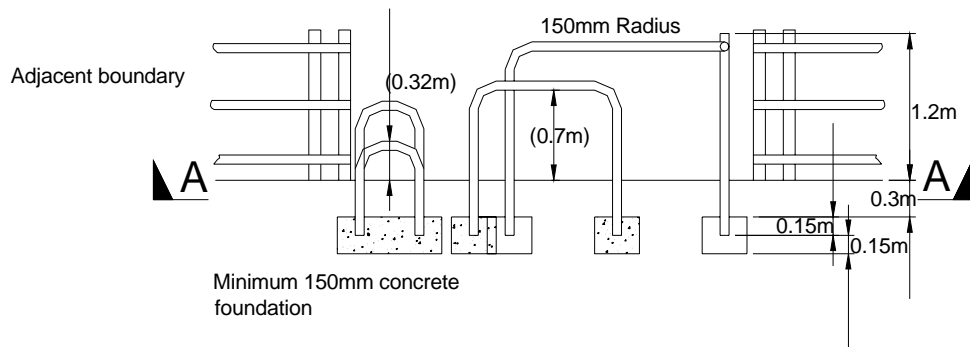

Dimensions bracketed are essential for the effective operation of the barrier

OPTION 3 : BARRIERS (WITH WHEELCHAIR BYPASS)

Initially omit barriers shown as shaded. These can be installed later if there proves to be a problem

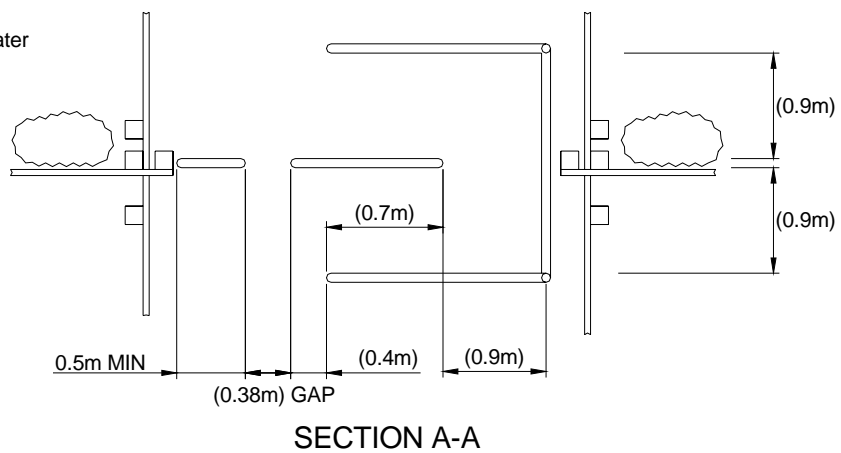

CONTENTS

<i>CLAUSE</i>	<i>TITLE</i>	<i>PAGE</i>
10.1	<u>GENERAL</u>	112
10.2	<u>EARTHWORKS</u>	125
10.3	<u>CARRIAGEWAY CAPPING AND SUB-BASE LAYERS</u>	131
10.4	<u>KERBS, CHANNELS AND EDGINGS</u>	135
10.5	<u>DUCTS</u>	140
10.6	<u>CONCRETE</u>	143
10.7	<u>BITUMINOUS MATERIALS</u>	154
10.8	<u>BLOCK PAVING FOR CARRIAGEWAYS</u>	167
10.9	<u>FOOTPATHS, FOOTWAYS AND CYCLEWAYS</u>	172
10.10	<u>REINSTATEMENT</u>	179
10.11	<u>ROAD MARKING</u>	184

CONTENTS

<i>CLAUSE</i>	<i>TITLE</i>	<i>PAGE</i>
10.1.1	<u>GROUND SITE INVESTIGATION REPORT</u>	113
10.1.2	<u>CONSTRUCTION THICKNESS</u>	114
10.1.3	<u>QUALITY OF MATERIALS AND WORKMANSHIP</u>	114
10.1.4	<u>TESTING OF MATERIALS</u>	115
10.1.5	<u>ACCEPTABLE MATERIALS</u>	116
10.1.6	<u>NOTIFICATION OF START OF WORKS</u>	119
10.1.7	<u>CONTACT DETAILS</u>	119
10.1.8	<u>QUALITY OF WORK</u>	119
10.1.9	<u>STATUTORY UNDERTAKERS APPARATUS</u>	119
10.1.10	<u>TEMPORARY SIGNS/SIGNALS</u>	119
10.1.11	<u>PROTECTION OF CARRIAGEWAYS</u>	120
10.1.12	<u>PROTECTION OF HIGHWAYS</u>	120

10 ROAD AND FOOTPATH CONSTRUCTION

10.1 GENERAL

10.1.1 Ground Site Investigation Report

- (i) General - The Developer shall procure a site investigation that shall include a desk study, walk over study, ground investigation, relevant in-situ and laboratory testing, investigation of contamination (if indicated by the desk study), reports of all factual findings and a report interpreting the findings together with the appropriate advice.

The desk study shall aim to determine to past history of the area of interest and all known knowledge relevant to the design and construction of a highway and its associated works (BS5930:1999:6.2, BRE Special Digest 1:5.2, BRE Digest 318).

The desk study, walk over study, planning of a ground investigation, selection of appropriate in-situ and laboratory testing, planning of an investigation of anticipated contamination, and the interpretation of the findings, including assessment of CBR design values, slope sustainability and settlement calculations where appropriate, and assessment of the Aggressive Chemical Environment for Concrete (ACEC) for use in BRE Special Digest 1 together with advice shall be performed by a geotechnical specialist and if indicated by the desk study supported by a geo-environmental specialist.

The ground investigation shall be performed in accordance with the current version of BS5930, using drillers accredited by the British Drilling Association (BDA).

The testing of soils shall be performed in accordance with the current version of BS 1377, by a laboratory currently holding the appropriate accreditation by the United Kingdom Accreditation Service (UKAS).

- (ii) Aggressive Ground Conditions - the site investigation and related testing shall be performed in such a manner as to enable the site classification for Aggressive Chemical for Concrete (ACEC) to be obtained.

BRE Special Digest 1 - "Concrete in Aggressive Ground - Part 1: Assessing the aggressive chemical environment" gives guidance on the site investigation and related testing to enable the site classification to be achieved.

- (iii) Formation Strength Determination by California Bearing Ratio - Where there is a requirement for carriageway construction design (Clause 5.2.14 and Table 5.2.2 the sub-grade formation strength shall be determined by California Bearing Ration (CBR) in accordance with the method for undistributed samples in accordance with BS 1377. Such samples must be taken prior to the commencement of construction activities.

The positions of the CBR samples shall be agreed with the Engineer prior to sampling and testing.

The number of samples taken will be such as to represent the variability and extent of the site such that a safe and economic design can be achieved.

Samples shall be taken at the greater depth beneath the existing ground level of either, a) 1m beneath existing ground or b) freshly exposed formation level.

Undistributed samples shall be obtained by the method given in BS 1377: Part 4: Section 7 - clause 7.2.5 and BS 1377: Part 9: Section 2 - clause 2.4.

Testing shall be in accordance with BS 1377: Part 4: Section 7 and shall be carried out on insitu moisture content.

Note: Where the CBR testing is carried out without the involvement of the Engineer and the Engineer considers that there is insufficient information then a supplementary investigation will be required, at the Developers expense, with additional CBR information obtained as directed by the Engineer.

(iv) The ground/site investigation report shall include classification of the soil, using the British Soil Classification System for Engineering Purposes as given by BS5930, on which any footpath, footway or footpath/cycletrack kerb line is to be founded. Soil classification is determined using the liquid limit, plastic limit and plasticity index as determined by BS1377 Classification Tests.

The soil classification will give an indication of the clay shrinkage into categories of CH - indicating high shrinkage CI - indicating medium shrinkage.

CL - indicating low shrinkage. The plastic limit will also determine if soils are non-plastic which will indicate non-shrinkable soils.

Where the soil classification is determined as:-

- (i) CH/CI then the depth of foundation shall be 600mm.
- (ii) CL or non-plastic then the depth of foundation shall be 450mm.

10.1.2 Construction Thickness

The thickness of material or layers of material given in this document, shall be the thickness after compaction and shall be determined from agreed measurements (dips). The material thickness must comply with those specified including tolerances, although the total minimum pavement thickness must not be less than 450mm.

10.1.3 Quality of Materials and Workmanship

In circumstances identified by the Engineer, certain materials, goods and workmanship may be required to conform to a quality management scheme, product certification scheme, have a British Board of Agreement Roads and Bridges

Certificate or have certification under the Highway Authorities Product Approval Scheme. The Developer shall refer to the Department of Transport Specification for Highway Works, Series 100, Clause 104 and Appendices A, B and C for further details.

In respect of any British Standard (BS), a BSI Kitemark Certification Scheme (if available), all materials required to comply with that Standard, or containers of such materials, shall be marked with the BSI Certification Trade Mark (the Kitemark).

The mark of conformity of any other certification body accredited by the National Council for Certification Bodies (NACCB) or equivalent shall be an acceptable alternative to this requirement.

The Engineer may reject any material and/or goods which do not comply with the specified standard or which are considered “not fit for purpose”.

Note Test Certificates issued by the supplier will not normally be accepted as providing satisfactory proof of compliance to specification. However, those test certificates which form part of an approved quality assurance scheme may be considered by the Engineer.

10.1.4 Testing of Materials

Before the commencement of works, the Engineer will require samples and/or sample loads of the various materials and/or goods to be used in the construction to be sampled and tested. If approved, these samples shall then be taken as representative of the standard required by the Engineer.

The Engineer reserves the right to sample and test at any time during construction any materials and goods that will form part of the permanent works to ensure compliance with the specification requirements.

The Developer shall ensure that all assistance is provided to obtain any sample at any time before or during the works.

All sampling and testing used for construction design purposes and to judge compliance to specification shall be carried out by a laboratory which holds United Kingdom Accreditation Service (UKAS) accreditation for the appropriate test.

A list of sampling procedures and test methods requiring UKAS accreditation is given in Appendix 10.1

Where the Developer submits to the Engineer sampling and/or test certificates for any goods or materials for which there is a requirement for UKAS accreditation then the certificates shall be accompanied by the UKAS testing schedule for the test laboratory and shall indicate the following:-

- (i) Address of the permanent laboratory
- (ii) Laboratory contact

- (iii) Issue date of schedule and issue number

10.1.5 Acceptable Materials and Secondary Aggregates

The use of slag (blast furnace or steel slag) must be from a source approved by the Engineer and must comply with the requirements given in notes (a) and (b) of clause 10.3.3 for bituminous mixes.

Materials and/or workmanship found not to comply with the specification requirements and deemed not to be fit for purpose shall not be included in the permanent works.

The Engineer shall determine if materials and/or workmanship are fit for purpose.

Secondary Aggregates

Developers should note that the Highway Authority encourages the use of secondary aggregates in those areas of construction covered by specification clauses 10.2 and 10.3.

All such materials are also subject to the specification requirements and conditions given in sections 10.1, 10.2 and 10.3 and shall be tested in accordance with clause 10.1.4.

Secondary aggregates may be a mixture of materials which in themselves would be acceptable to the Engineer (e.g. granular capping/sub-base, crushed concrete, bituminous planings etc.) but must be free from

- (i) Contaminates at a level which pose a risk to health,
- (ii) Combustible material
- (iii) Domestic refuse
- (iv) Other materials which, in the opinion of the Engineer, may affect the durability of the permanent works.

Where secondary aggregates are proposed for use then the Developer shall submit to the Engineer the following minimum information:-

- (a) *A brief but accurate description of the material and the original source.*
- (b) *All physical and chemical testing as required by the specification.*
- (c) *Identify to the Engineer those areas within the permanent works where the materials are to be used.*

Where secondary aggregates include cement bound materials and they are intended for use below ground level then their use shall be restricted to those ground conditions which have been classified as having a Design Chemical Class of DC-1 when assessed in accordance with the document BRE Special Digest 1 – Concrete in Aggressive Ground.

The Engineer may also require a sample load to be delivered for inspection and testing.

Source approval

The approval for the supply of secondary aggregates from any source shall only be given where there is in place a QUALITY PLAN. This Quality Plan shall follow the guidance given in the BRE DOCUMENT – QUALITY CONTROL – THE PRODUCTION OF RECYCLED AGGREGATES.

The Quality Plan shall cover as a minimum the following areas:-

- 1) Acceptance criteria for the incoming material:-
 - i) The producer shall have and maintain procedures for acceptance of incoming material.
 - ii) All statutory and regulatory requirements for the receipt of incoming material shall be observed and included in the Acceptance Criteria.
 - iii) The Acceptance Criteria shall identify the types of material that every incoming load shall have a visual inspection and gives a list of materials which require particular attention.
 - iv) The visual inspection shall assess each incoming load for the approximate percentages of sand, gravel (stony material), asphalt, wood, glass and other foreign material such as metal, plastic, clay lumps.
 - v) A record of each consignment delivered and accepted shall be kept and shall identify:-
 - a) date of acceptance
 - b) nature and quality
 - c) place of origin if known
 - d) quality by weight or volume
 - e) carrier
 - f) supplier
- 2) A definition of material types produced e.g. Sub-base type 1, capping, granular fill
- 3) Specification requirements for the product
- 4) Method statement of production

This production statement shall detail the process, the process controls and the range of products produced.

- 5) Inspection and testing regime

The inspection and testing regime shall be detailed. The extent of inspection and testing will be related to the finished product, the quality of the incoming material and the production controls.

Where the finished product is intended for use as SUB-BASE TYPE 1 then the following test regime and acceptance criteria is required:-

Test	Test Method	Frequency	Limits
*Water absorption	BS EN 1097 & BS 812	1/every production day	8.5% max
Grading	BS EN 933 & BS 812	1/week	SHW
Composition	Digest 433	1/week	
Los Angeles Fragmentation Test	BS EN 1097	1/month	50kn min
Soundness	BS EN 1367	1/month	
Frost heave	BS 812	1/3 months	15mm max

Note the grading and the composition for the frost heave sample shall reflect the normal production grading and composition.

***The water absorption shall be used as a screening test. Material which has a water absorption greater than 8.5% shall not be used as sub-base material.**

All testing shall be performed by a UKAS laboratory which holds accreditation for that test.

6) Records

Records shall be retained for all incoming materials, products and all testing information relating to the products.

Note – all new sources of supply shall show, by historical testing data, evidence that the production process can supply material types to the specification requirements.

7) Conformity declaration

Delivery documentation shall state that the product was manufactured under a Quality Control Scheme conforming with the BRE Quality Control Document.

8) Information to be provided by the producer

When requested by the Engineer the producer shall provide:-

- a) test results
- b) test procedures
- c) the Quality Plan

10.1.6 Notification of Start of Works

The Developer must inform the Engineer in writing at least 7 days before the work starts. If construction work is to stop for any substantial period then the Developer must notify the Engineer in writing and confirm the proposed date for the restart of the work.

10.1.7 Contact Details

The Developer shall supply to the Engineer all relevant contact names and telephone numbers for emergency and out of hours work.

10.1.8 Quality of Work

Where Codes of Practice, British Standards or equivalent or European Standards indicate standards of workmanship, these shall be the minimum quality of work acceptable.

10.1.9 Statutory Undertakers Apparatus

The Developer is advised to consult with the Statutory Undertakers regarding existing services and for the provision of new services. The installation of all services must be completed prior to surfacing works. Where installation occurs after surfacing works then reinstatement shall be in accordance with Section 10.10.

Statutory Undertakers and other bodies apparatus should wherever possible be located in verges, footpaths, footways or cycletracks and preferably laid in the following sequence from the kerb line; telephone, other communications, water, gas, electricity in accordance with the National Joint Utilities Group (NJUG) recommendations, unless prior approval of the Engineer has been obtained for an alternative location.

The location of any Undertaker's apparatus above ground, or any street furniture, shall be agreed with the Engineer.

The Developer is responsible for the satisfactory installation of all mains and services and all associated backfilling of trenches and reinstatements within the area to be adopted. Refer to Clauses 10.2.6, 10.10.1 and 12.4.4.

On completion of the development the Developer must, in accordance with the New Roads and Street Works Act (NRSWA) 1991, supply to the Engineer a plan identifying the location and position of all Statutory Undertakers apparatus.

10.1.10 Temporary Signs/Signals

For all works carried out within the development, the Developer shall ensure that all signing is to the satisfaction of the Engineer and complies with Chapter 8 of the Department of Transport's "Traffic Signs Manual". The use of temporary traffic signals shall be in full accordance with NEHAUC agreed working procedure GN2/93/2003.

The Developer has a civil law liability to warn road users of obstructions on the highway, as a consequence of the development.

10.1.11 Protection of Carriageways

The Developer shall employ mechanical equipment and/or labour to keep all roads, footpaths and footways clean and free from dust, mud, slurry and any obstruction to the satisfaction of the Police and Highway Authority.

Should the Developer fail to comply with this requirement, the Engineer will invoke Section 148 or 149 of the Highways Act 1980 (see Clause 4.6).

10.1.12 Protection of Highways

Any damage or subsidence to an adjoining Highway which may occur during the progress of the works or maintenance period, attributed to any fault or careless workmanship by the Developer, shall be made good by the Developer at their own expense to the satisfaction of the Engineer.

SAMPLING AND TEST METHODS IN ACCORDANCE WITH UKAS

APPENDIX 10.1

TYPES OF SITE LOCATION	MATERIALS/PRODUCTS TESTED TYPES OF TESTS/ PROPERTIES MEASURED RANGE OF MEASUREMENT	STANDARD SPECIFICATION EQUIPMENT/ TECHNIQUES USED
CIVIL ENGINEERING CONSTRUCTION SITES	AGGREGATES Physical Tests In-situ density	Documented In-House Method No. CCC TP 97 Nuclear Density Meter
	BITUMINOUS MIXTURES for roads and other paved areas Sampling Sampling from - around the augers of the paver Sampling coated chippings from stockpiles	BS 598: Part 100: 1987 BS 598: Part 100: 1987
	CONCRETE – Fresh Physical Tests Slump Air content – method A Sampling Sampling fresh concrete on site Sampling from initial discharge (slump test) Making test cubes	BS 1881: Part 102:1983 BS 1881: Part 106:1983 BS 1881: Part 101:1983 BS 1881: Part 102:1983 BS 1881: Part 108:1983
	IN-SITU FLOORINGS – polymer modified cementitious wearing surfaces Physical Tests Slip resistance value (SRV)	BS 8204: Part 3: 1993
	IN-SITU FLOORINGS – terrazzo wearing surfaces Physical Tests Slip resistance value (SRV)	BS 8204: Part 3: 1993

TYPES OF SITE LOCATION	MATERIALS/PRODUCTS TESTED TYPES OF TESTS/ PROPERTIES MEASURED RANGE OF MEASUREMENT	STANDARD SPECIFICATION EQUIPMENT/ TECHNIQUES USED
CIVIL ENGINEERING CONSTRUCTION SITES	PAVED SURFACES Physical Tests Skid resistance value	TRRL Road Note 27/69
	ROAD PAVEMENT MATERIALS Physical Tests In-situ density	Document In-House Method No. CCC TP 97 using Nuclear Density Meter
	BITUMINOUS ROAD SURFACING Physical Tests Texture depth – using TRRL mini texture meter	Specification for Highway Works, HMSO August 1986 Clause 929
	ROAD PAVEMENT SURFACES Physical Tests Texture depth – by the sand-patch method Surface regularity using a rolling straight edge	BS 598: Part 105: 1990 Specification for Highway Works, HMSO December 1991 Clause 702
	SOILS for civil engineering purposes Physical Tests MCV – natural moisture content In-situ density – core cutter method	BS 1377: Part 4: 1990 BS 1377: Part 9: 1990
AGGREGATES	Physical Tests Particle size distribution – washing and sieving Particle size distribution – dry sieving Flakiness index Moisture content – oven drying method	BS 812: Part 103: Section 103:1 1985 BS 812: Part 103: Section 103:1 1985 BS 812: Part 105: Section 105:1 1989 BS 812: Part 109: 1990

TYPES OF SITE LOCATION	MATERIALS/PRODUCTS TESTED TYPES OF TESTS/ PROPERTIES MEASURED RANGE OF MEASUREMENT	STANDARD SPECIFICATION EQUIPMENT/ TECHNIQUES USED
BITUMINOUS MATERIALS	Physical Tests Needle penetration – 25°C Softening point – ring and ball method	BS 2000: Part 49 1993 BS 2000: Part 58: 1993
BITUMINOUS MIXTURES for roads and other paved areas	Mechanical Tests Determination of the composition of design wearing course rolled asphalt (loads from 1 to 25kN) Physical Tests Binder content and grading of mineral aggregate – extraction bottle method: binder directly determined, filler by difference Rate of spread of coated chippings – clause 4.2	BS 598: Part 107: 1990 BS 598: Part 102:P 1996 BS 598: Part 108: 1990
CONCRETE – fresh	Physical Tests Slump Air content – method Sampling Making test cubes in the laboratory	BS 1881: Part 102: 1983 BS 1881: Part 106: 1993 BS 1881: Part 108: 1983
CONCRETE – hardened	Mechanical Tests Compressive strength of cubes – including curing (loads from 40 to 2500 kN) Compressive strength of cores (loads from 40 to 2500 kN) Physical Tests Density Measurement and examination of cores	BS 1881: Part 116: 1983 BS 1881: Part 111: 1983 BS 1881: Part 120: 1983 BS 1881: Part 114: 1983 Document In-House Method No. 321 (November 1996)
IN-SITU FLOORINGS – polymer modified cementitious wearing surfaces	Physical Tests Slip resistance value (SRV)	BS 8204: Part 3: 1993

TYPES OF SITE LOCATION	MATERIALS/PRODUCTS TESTED TYPES OF TESTS/ PROPERTIES MEASURED RANGE OF MEASUREMENT	STANDARD SPECIFICATION EQUIPMENT/ TECHNIQUES USED
IN-SITU FLOORINGS – terrazzo wearing surfaces	Physical Tests Slip resistance value (SRV)	BS 8204: Part 4: 1993
PAVED SURFACES	Physical Tests Measurement and examination of cores	Documented In-House Method No. 321 (November 1996)
PRECAST CONCRETE FLAGS, KERBS, CHANNELS, EDGINGS and QUADRANTS	Mechanical Tests Transverse strength (loads from 5 to 100 kN)	BS 7263: Part 1: 1990
SOILS for civil engineering purposes	Mechanical Tests California Bearing Ratio (CBR) (loads from 0.2 to 20kN) Undrained shear strength – triaxial compression without measurement of pore pressure (loads from 0.2 to 20 kN) Physical Tests Moisture content – over drying method Liquid limit – cone penetrometer Physical Tests Plastic limit Plasticity index and liquidity index Linear shrinkage Particle density – gas jar Particle density – small pycnometer Particle size distribution – wet sieving Particle size distribution – dry sieving Particle size distribution – sedimentation – pipette method Dry density/moisture content relationship (2.5 kg rammer) Dry density/moisture content relationship (4.5 kg rammer) MCV – natural moisture content MCV/moisture content relation One-dimensional consolidation properties	BS 1377: Part 4 1990 BS 1377: Part 7 1990 BS 1377: Part 2 1990 BS 1377: Part 2 1990 BS 1377: Part 2 1990 BS 1377: Part 2 1990 BS 1377: Part 2 1990 BS 1377: Part 2 1990 BS 1377: Part 2 1990 BS 1377: Part 2 1990 BS 1377: Part 2 1990 BS 1377: Part 2 1990 BS 1377: Part 4 1990 BS 1377: Part 4 1990 BS 1377: Part 4 1990 BS 1377: Part 4 1990 BS 1377: Part 4 1990

CONTENTS

<i>CLAUSE</i>	<i>TITLE</i>	<i>PAGE</i>
10.2.1	<u>SITE CLEARANCE</u>	126
10.2.2	<u>EXCAVATION</u>	126
10.2.3	<u>UN SOUND GROUND AND FILL MATERIAL BELOW FORMATION</u>	126
10.2.4	<u>GENERAL FILL MATERIAL</u>	127
10.2.5	<u>STANDING WATER</u>	129
10.2.6	<u>ROAD AND FOOTPATH INFORMATION</u>	129

10.2 EARTHWORKS

10.2.1 Site Clearance

Trees and hedges shall where necessary be removed from the site of the works, the roots shall be completely grubbed out and the resultant hole filled and compacted to the satisfaction of the Engineer.

Note The Developer is required, where possible, to work within the guidelines given in BS5837 – Trees in Relation to Construction.

Before depositing any fill material, all turf and vegetable soil within the adoptable works shall be excavated and removed to stockpiles.

10.2.2 Excavation

Excavation shall be to the line, level and profile shown on the approved drawings. Excess excavation shall be made good with material in accordance with Clause 10.2.3 or capping material in accordance with Clause 10.3.2 or sub-base material in accordance with Clause 10.3.3 and placed and compacted to the satisfaction of the Engineer.

Excavation in a cohesive material shall stop a minimum 150mm above the formation level until the sub-base material is ready to be placed in order to avoid damage to the formation.

10.2.3 Unsound Ground and Fill Materials Below Formation

Unsound ground, unsuitable material or soft spots found within the road/footpath formation shall be excavated as directed by the Engineer and replaced with approved granular fill material.

Note This granular fill material shall be chosen to suit the particular problems encountered and may be any of the following types:-

- (i) uniformly graded material having a uniformity coefficient of less than 10
- (ii) well graded material having a uniformity coefficient exceeding 10

The nominal size of the material shall be chosen with due regard for the site conditions but should not be less than 40mm.

When using well graded material the material shall be spread in layers not exceeding 200mm thick and compacted to refusal.

The compaction technique used shall be such as not to cause further instability within the formation.

Compaction shall be completed as soon as possible after the material has been spread. The material shall be transported, laid and compacted without undue segregation.

Any subsequent construction settlement due to the failure of the sub-grade will remain the Developer's responsibility.

10.2.4 General Fill Material

(i) Embankments

Embankments shall be constructed with acceptable earthworks materials in accordance with the Department of Transport Specification for Highway Works (SHW) – Series 600 – Earthworks.

All fill materials shall require the approval of the Engineer.

Note Class 1B uniformly graded granular material in accordance with table 6/1 of the SHW has shown in the past not to perform well as embankment fill and therefore will not be permitted.

(ii) Site Investigation

The Developer shall inform the Engineer in writing that the Site Investigation reports contain information that indicates that the area of interest is contaminated. The reference in the Site Investigation reports to the type, distribution and concentration of the contaminants together with an assessment of their impact on the intended works and proposed method of remediation shall be reported to the Engineer.

Advice on the design and execution of a site/ground investigation should be obtained from a specialist consultant. Attention is drawn to the following documents:-

NHBC Standards, Chapter 4.1, Land Quality – Managing Ground Conditions.

BS5930 Code of Practice of site investigations.

Remedial Action – Where a site/ground investigation has shown that contaminants are present over the whole or part of the site in concentrations that indicate that remedial action may be necessary, the Developer must provide the Engineer with the following information:-

- (a) the nature and concentrations of contaminants
- (b) the hazards associated with those contaminants
- (c) the intended remedial action

Note The remedial action will normally be one or a combination of the following methods, all of which would require the Engineer's approval.

- (1) Contaminated material is excavated and removed for disposal off site and replaced (if necessary) by uncontaminated imported fill.
- (2) The contaminated material is isolated beneath, (and where necessary laterally) by a suitable thickness of imported, clean cover material at the interface with the contaminated material.
- (3) The material is chemically or physically treated without removal to reduce the contamination.

Breaklayer – Where the remedial action involves the covering of contaminated material with a breaklayer then the breaklayer shall be as follows:-

The Developer must provide a minimum breaklayer of 1000mm thickness. The aggregate used for the breaklayer shall be unbound, inert and non-water susceptible graded to the requirements of SHW, Series 600 Table 6/2 Class 6F1 or 6F2.

The breaklayer shall be placed and compacted in accordance with the method compaction requirements of Clause 612 and method 6 of Table 6/4 given in SHW 600 series.

The breaklayer thickness may be reduced to a minimum thickness of 600mm subject to approval by the Engineer on the material source, material type and grading and the use of end product compaction requirements as given by Clause 612 of the SHW. Examples of permitted material types for a reduction to 600mm are whinstone, carboniferous limestone, magnesium limestone, blast furnace or steel slag from an approved source.

The use of permanent hard surface cover as a breaklayer will be considered depending upon the nature of the contaminates and the concentrations of such contaminates.

The Developer shall provide to the Engineer all relevant materials testing information after construction of the breaklayer indicating that all aspects of the above specification have been achieved and this shall include the following as a minimum:-

- (a) aggregate source and type
- (b) grading
- (c) compaction achieved (where applicable)

Where the use of a breaklayer has been approved, then information is required by the Engineer to assess compliance with the Specification in respect of the permanent hard surface cover.

Embankments above a breaklayer must be constructed with imported material from a source approved by the Engineer. The use of in-situ reclaimed material will not be permitted.

(iii) Fill to structures

Fill to structures shall be in accordance with the requirements of the Specification for Highway Works (SHW) – Series 600 – clause 610 with the exception that the material shall be normally be restricted to Class 6N (selected well graded granular material) or 7B (selected conditions pulverised fuel ash).

Where the Developer wishes to use other fill material approval must be given by the Engineer and the fill must comply with the requirements of clause 610 and table 6/1 of the SHW.

10.2.5 Standing Water

The Developer shall arrange for the rapid dispersal of water shed onto or entering the works from any source at any time during construction. Where necessary temporary ditches, watercourses, pumping or other means of maintaining the works free from standing water shall be used. The water shall be discharged only to locations approved by the Engineer.

Care must be taken to prevent solid matter or matter in suspension from entering any drains or sewers. Any obstruction shall be removed by the Developer.

10.2.6 Road and Footpath Formation

The Engineer will require a minimum 24 hours notification from the Developer prior to the commencement of the following works.

- (i) The placing of capping or sub-base material on the formation.
- (ii) The placing of any kerbs or channels on the kerb raft.
- (iii) The laying of any bituminous material.

All trenches in the sub-grade shall be backfilled in accordance with Clause 12.4.4 to the satisfaction of the Engineer prior to the final preparation of the formation which shall be carried out as follows:-

- (i) All formations shall, after reinstatement of any soft areas, shall be clean and free from mud and slurry. Soft and unstable areas within the formation are often highlighted by rolling and/or construction traffic.
- (ii) The carriageway formation shall be compacted by at least four passes of a 'smooth wheeled' dead weight roller having a load of 6-12 tonne to the satisfaction of the Engineer.
- (iii) During completion of the footpath formation, due regard shall be made to service installations and be compacted by at least 4 passes within a 2.5 tonne dead weight roller to the satisfaction of the Engineer.

- (iv) The formation shall be regulated and trimmed (by hand if necessary) to the correct levels and profiles. Trimmed formations shall be rolled as in (ii) or (iii) as appropriate.

On completion, the formation (unless directed otherwise by the Engineer) shall be sprayed, with an approved weedkiller. This operation shall be completed before overlaying the formation with capping (where required) or sub-base.

When completed, the prepared formation shall be clean, free from mud and slurry, shaped to the required level and be within the specified surface tolerances (see Clause 10.3.1).

Construction traffic shall not be allowed to run on the prepared formation without the Engineer's approval. Any damage caused to the formation (by any means) shall be rectified to the satisfaction of the Engineer prior to the placing of capping (where required) or sub-base material.

The Developer must arrange the work so that the earthworks, formation preparation, capping layer (where required) and sub-base laying proceeds as a continuous operation.

CONTENTS

<i>CLAUSE</i>	<i>TITLE</i>	<i>PAGE</i>
10.3.1	<u>TOLERANCES FOR CARRIAGEWAY CONSTRUCTION</u>	132
10.3.2	<u>CAPPING LAYERS</u>	132
10.3.3	<u>SUB-BASE MATERIAL AND GRADING (TYPE 1)</u>	133
10.3.4	<u>COMPACTION</u>	133
10.3.5	<u>FROZEN MATERIALS</u>	134

10.3 CARRIAGEWAY CAPPING AND SUB-BASE LAYERS

10.3.1 Tolerances for Carriageway Construction

The following tolerances shall apply to the material surface levels :-

Formation	+/- 30mm
Capping Layer	+/- 30mm
Sub-base	+0/- 30mm

10.3.2 Capping Layers

A capping layer must be provided where the CBR value of the formation is less than 5% at a thickness as indicated in Table 10.3.1.

TABLE 10.3.1

% CBR OF SUB-GRADE	THICKNESS OF CAPPING LAYER MM	MINIMUM THICKNESS OF SUB-BASE (TYPE) MM	
		Categories 1 & 2	Categories 3,4 or 5
> 5%	Nil	250	280
> 2% - 5%	275	250	280
2% - 2%	525	250	280

Note The capping layer is not a substitute for the sub-base and it is not to be considered as forming part of the carriageway construction thickness.

Where a capping layer is required it shall achieve a CBR value of not less than 15% when tested in accordance with Test Method 7 of B.S.1377.

Selected granular fill material used as capping materials shall comply with the requirements of the Specification of Highway Works – 600 Series – Clause 613 and Table 6/1.

Note – Capping materials :- 6F1 and 6F2 are those obtained within the works, 6F3 is for bituminous planning and granulated asphalt only but must not include tar or tar-bitumen binders, 6F4 and 6F5 are reserved for material imported to the site and be any materials or combination of materials but must not include shale, unburnt colliery shale, chalk or bituminous materials.

Capping layers shall be compacted in accordance with Clause 10.3.4 and Table 10.3.3.

Aggregates for capping shall be from a source approved by the Engineer. They shall be free from detritus such as slag (from any source other than that approved by the Engineer), clay, plaster, wood, domestic waste, industrial refuse and any other material which in the opinion of the Engineer would adversely effect the durability of the highway.

10.3.3 Sub-Base Material

The sub-base material shall comply with the requirements of the Specification of Highway Works – 800 Series – Type 1. Acceptable materials shall be crushed rock (excluding shale), crushed blast furnace slag, crushed concrete, secondary and recycled aggregates. The material must not be frost susceptible when tested in accordance with BS812.

All sources of aggregate require the Engineers approval.

Notes

- (a) Slag material shall comply with the requirements of BS EN 12620 Appendix A with the exception that the analytical test for dicalcium silicate unsoundness shall satisfy both conditions of sub-clause E3.1 of that British Standard. The bulk density of slag shall not be less than 1100 kg/m³.
- (b) The aggregate used for sub-base material shall be from a source approved by the Engineer. Where a source is proposed by the Developer which is unknown to the Engineer, then all of the requirements of the Specification for Highway Works Series 800 shall apply and approval will only be given when full compliance with these requirements is shown.
- (c) The sub-base material shall have a Los Angeles fragmentation value of less than La50 when tested in accordance with BS EN 1097.

10.3.4 Compaction

The material shall be placed, spread in layers not exceeding 150mm thick and compacted to the satisfaction of the Engineer.

Table 10.3.3 gives a guide to compaction requirements but the Engineer may require further compaction to be carried out.

TABLE 10.3.3

TYPE OF COMPACTION PLANT	CATEGORY	NUMBER OF PASSES FOR	
		Not Greater than 110 mm	Not Greater than 150 mm
Smooth wheeled Roller	Mass per metre width of Roller 2.5 – 5.5 tonne over 5.5. tonne	16 8	Not suitable 16

Notes

- (a) The use of vibrating rollers will not be permitted.
- (b) All loose, or segregated, areas shall be made good to the full thickness of the layer and re-compacted. Where clay or other sub-grade material has worked through the sub-base the area shall be dug out together with any defective formation and replaced with new material and compacted as described in Clauses 10.2.3 and 10.2.6.
- (c) The road base should be laid as soon as possible after the sub-base has been prepared. If by using the sub-base as a “working platform” contamination, damage or deterioration to the formation and/or sub-base occurs, then this shall be rectified to the satisfaction of the Engineer before the road base material is laid.

Where a final trim to the sub-base is required, then the base (road base) shall not be laid until this final trim has been inspected by the Engineer.

Only those vehicles and equipment necessary for the laying of the base (road base) material shall be allowed to traffic the area during the laying operations.

The sub-base thickness may have to be increased to ensure a minimum carriageway thickness of 450mm (clause 10.7.2).

10.3.5 Frozen Materials

Frozen material shall not be used but may be retained on site for use when free from frost and ice, subject to the approval of the Engineer. No material shall be laid on any surface that is frozen or covered with ice.

<i>CLAUSE</i>	<i>TITLE</i>	<i>PAGE</i>
10.4.1	<u>PRE-CAST CONCRETE PRODUCTS</u>	136
10.4.2	<u>NATURAL STONE KERBS</u>	136
10.4.3	<u>EDGINGS</u>	136
10.4.4	<u>FOUNDATIONS</u>	136
10.4.5	<u>INSTALLATION</u>	137
10.4.6	<u>MORTAR BEDDING</u>	137

10.4 KERBS, CHANNELS AND EDGINGS

10.4.1 Pre-Cast Concrete Products

Precast concrete kerbs, channels and edgings shall comply with the requirements given in B.S. 7263-3 and shall be laid in accordance with the requirements of B.S. 7533 – Part 4 with the exceptions as given below (see clause 10.4.3 – Edgings). The units shall have performance requirements as given below:

- (a) Weathering resistance – all units shall be of class W2.
- (b) Abrasion resistance – all units shall be class A2.
- (c) Slip/skid resistance – all units for predominately pedestrian use shall be of class S2. For channels and kerbs laid as channels in areas of vehicular use shall be of class S3.

Note: Testing the above performance requirements shall be in accordance with the relevant annex of B.S. 7263-3.

10.4.2 Natural Stone Kerbs

Natural stone kerbs shall only be used with the approval of the Engineer and shall comply with B.S.435 and be igneous rock of a size 200mm x 150mm x 75mm. Samples shall be submitted to and approved by the Engineer prior to their use and the kerbs used shall be equivalent or superior to the approved sample.

10.4.3 Edgings

Flat top edgings shall be laid as follows:

They are to finish flush with the footpath level and laid with butt joints bedded on 15mm thick 3:1 cement mortar (see sketch 10.4.6) or laid directly onto the concrete foundation (see sketch 10.4.1).

10.4.4 Foundations

The foundations shall be constructed using S2 concrete complying with the requirements of BS EN 206 and shall be constructed with formwork set to the required line and level. The concrete shall be well compacted to provide a dense homogeneous mass.

Kerb foundations shall have hooped mild steel bars 10mm diameter by 350mm long at 600mm centres which are to be set into the foundation as the concreting proceeds to provide a key for the concrete backing.

Foundation widths must not be wider than that required to carry the kerb, channel (where required) and backing. (See Sketch 10.4.2).

For foundations to footpath, footway or footpath/cycletrack, the requirements of Clause 10.1.1 (vi) in respect to soil classification must be noted.

10.4.5 Installation

- (i) Kerbs and Channels – Kerbs and channels (where required) shall be laid in full lengths. Where “piecing up” is necessary, units must not be cut to less than half length.

Note Should the Developer wish to omit the kerb until building works are substantially complete, then the channels must be temporarily backed with S2 concrete to the satisfaction of the Engineer.

After buildings works are substantially complete and the Developer wishes to complete the kerbing works, the temporary concrete backing shall be removed.

Kerbs and channels (where required) are to be laid with butt joints on a mortar bed (see Clause 10.4.6) not less than 10mm or greater than 40mm thickness to comply with the finished level and in the case of kerbs to produce a 125mm or 100mm kerb face.

In shared surfaces a kerb face of 50mm may be acceptable, with the approval of the Engineer and in these situations only small element units complying to B.S. 7263 shall be used.

For channels less than 6m radii, straights shall be used having a minimum length of 300mm. Gaps formed by this construction method shall be filled and sealed using a material to be approved by the Engineer.

Damaged kerbs and/or channels will be inspected by the Engineer and those considered as having minor damage, may be repaired using a concrete repair system approved by the Engineer. Other damaged kerbs and/or channels shall be removed, replaced and the foundation cleaned prior to the kerbs and/or channel being re-laid.

Kerbs and/or channels shall be laid to the design level +/-6mm. Any kerb and/or channel found to be more than 3mm out of line and level over a 3m length shall be lifted and re-laid.

Kerbs shall not be backed until installation works have been approved by the Engineer.

- (ii) Edgings – Edgings shall finish flush with the footpath level and shall be laid with butt joints. They shall be bedded on a mortar bed of thickness not less than 10mm and not greater than 20mm. Where required for piecing up they must not be less than 300mm in length.

10.4.6 Mortar Bedding

Mortar bedding layers shall consist of freshly mixed moist mortar of 3 : 1 sand : cement (proportions by volume) using a sand complying with BS EN 13139, 0/4 MP. Cement mortars, which have been mixed and not used for more than 2 hours shall be discarded.

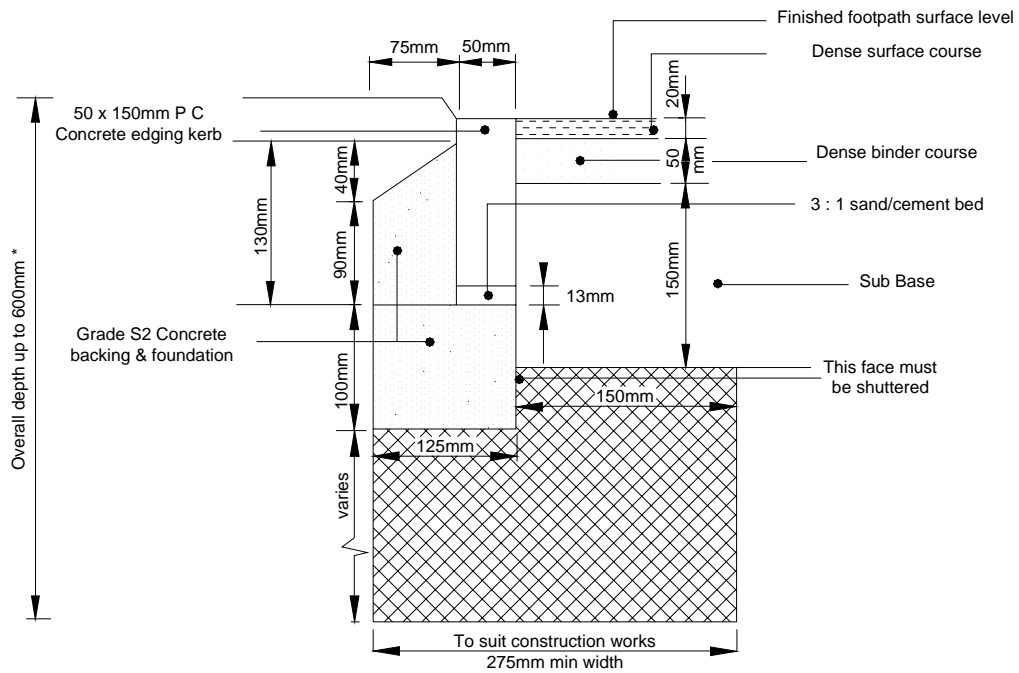

BITMAC FOOTPATH / CYCLETRACK

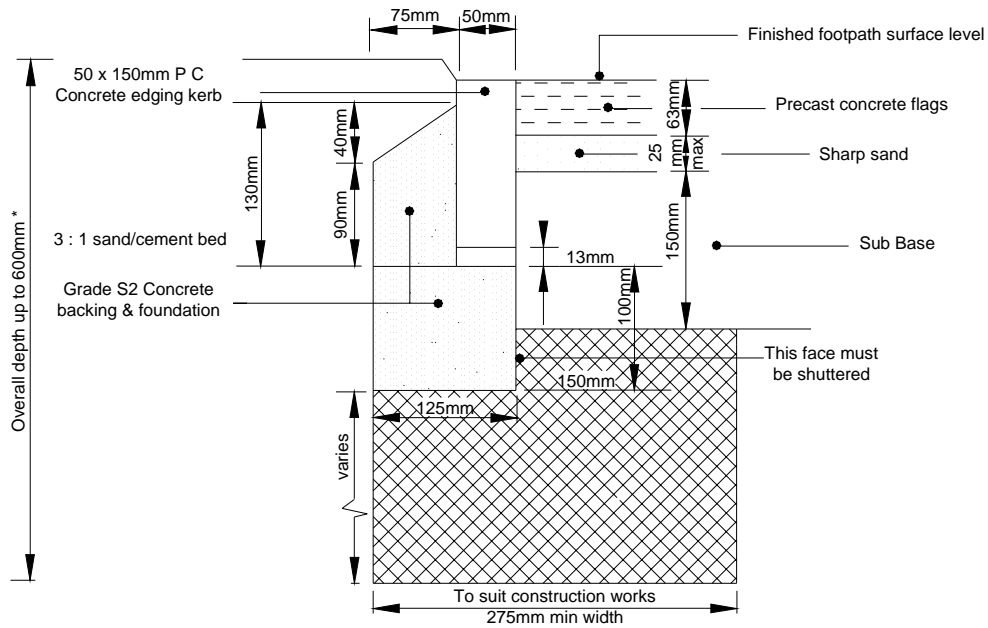

FLAGGED FOOTPATH

* Note Actual thickness dependant upon soil classification

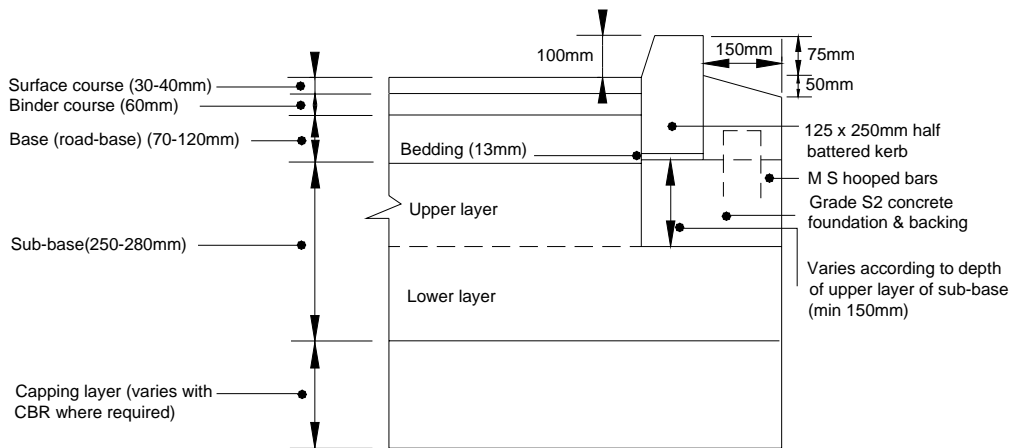

TYPICAL KERB AND CARRIAGEWAY CONSTRUCTION DETAIL

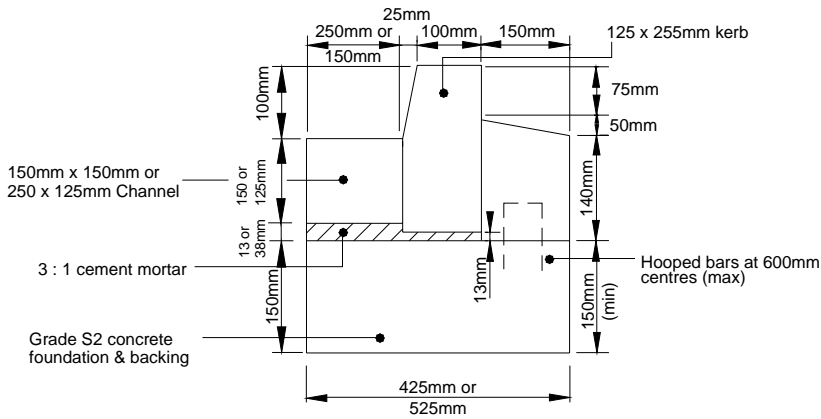

TYPICAL KERB AND CHANNEL DETAIL

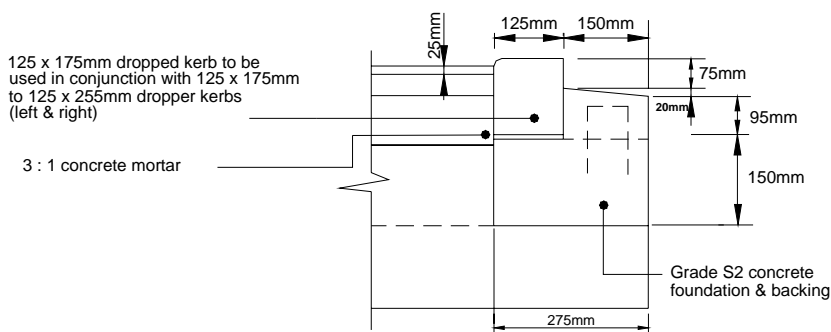

TYPICAL CROSSING KERB DETAIL

CONTENTS

<i>CLAUSE</i>	<i>TITLE</i>	<i>PAGE</i>
10.5.1	<u>CROSS ROAD DUCTS</u>	141
10.5.2	<u>DUCT MARKERS</u>	141
10.5.3	<u>SKETCHES</u>	141

10.5 DUCTS

10.5.1 Cross Road Ducts

Ducts for mains and service crossings under roads are to be laid in accordance with the requirements of the Statutory Undertakers at an approximate depth of 750mm below the surface of the carriageway. They shall generally be 100mm diameter and extend into the footpath or verge 300mm behind the kerb foundation.

All telecommunications ducts shall be set a minimum of 1.5m from any others.

The ducts are to be surrounded for their entire length in 150mm S2 grade concrete and the ends of the pipe sealed to prevent ingress of any material. A draw cord shall be provided through the duct.

10.5.2 Duct Markers

A marker is to be placed in the kerb backing above the duct position and flush with the top of the kerb on both sides of the road. If the kerb is not to be provided until a later stage of the works the duct marker shall be temporarily placed behind the channel and on laying the kerb the duct marker shall be relocated behind the kerb.

Duct markers shall be pre-cast concrete posts 60mm square by 125mm or 275mm long. The top face shall be finished smoothly with the letter of the service recessed therein as shown below.

E – Electricity

G – Gas

W – Water

T – Telecom

SL – Street Lighting

C – Other

10.5.3 Sketches

Typical detail are shown on Sketch 10.5.1

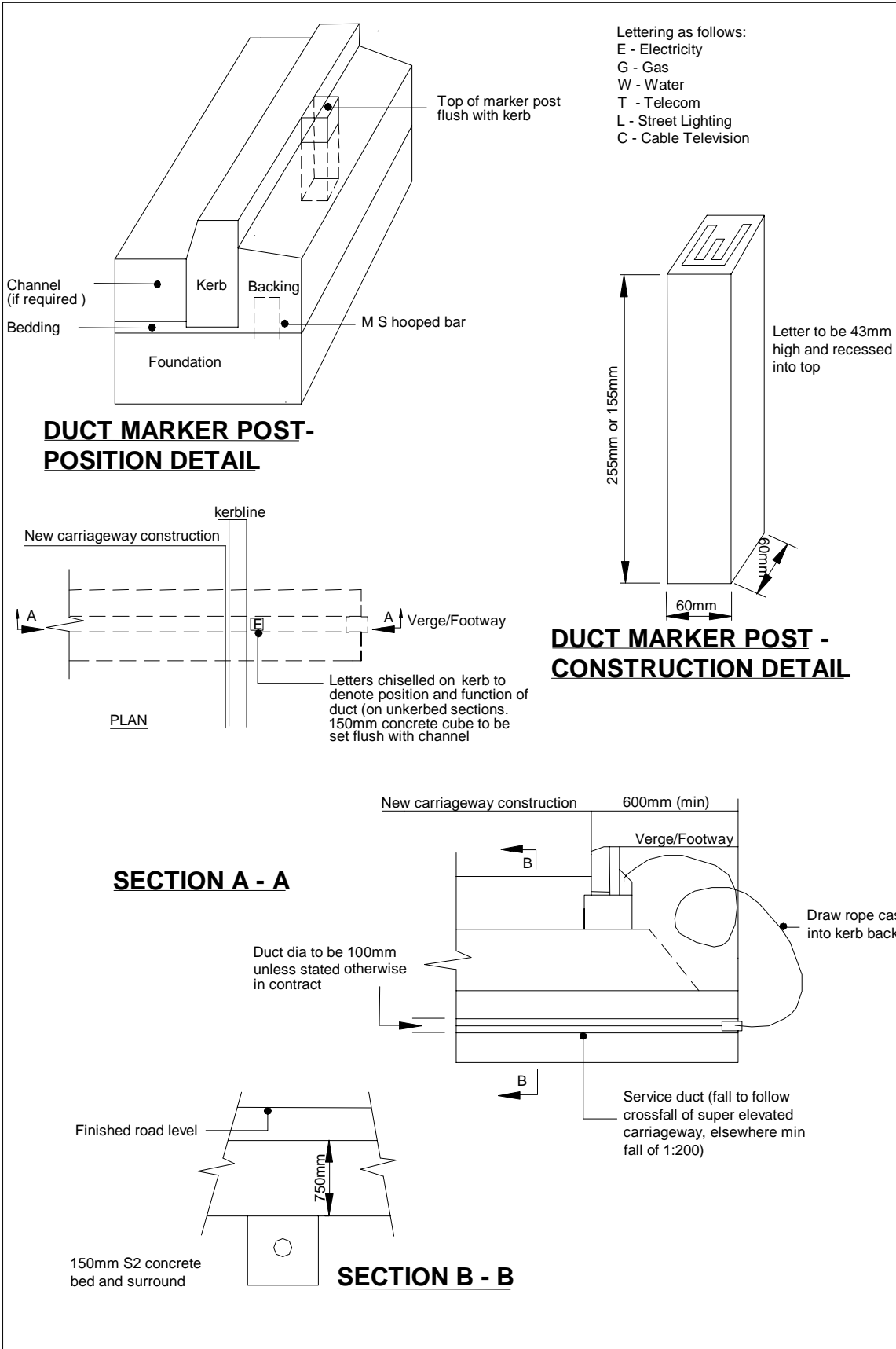

TYPICAL SERVICE DUCT DETAIL

Sketch No 10.5.1

CONTENTS

<i>CLAUSE</i>	<i>TITLE</i>	<i>PAGE</i>
10.6.1	<u>MIXES AND QUALITY</u>	144
10.6.2	<u>STRUCTURAL CONCRETE</u>	144
10.6.3	<u>CONCRETE GRADES</u>	144
10.6.4	<u>CONSTITUENT MATERIALS OF CONCRETE</u>	146
10.6.5	<u>PROPERTIES OF FRESH CONCRETE</u>	147
10.6.6	<u>READY MIXED CONCRETE</u>	148
10.6.7	<u>FORMWORK</u>	148
10.6.8	<u>PLACEMENT</u>	149
10.6.9	<u>COLD WEATHER WORKING</u>	149
10.6.10	<u>COMPACTION</u>	150
10.6.11	<u>SAMPLING AND TESTING</u>	150
10.6.12	<u>DEFECTS IN CONCRETE</u>	150
10.6.13	<u>REINFORCEMENT FOR LAY-BYS</u>	150
10.6.14	<u>AIR-ENTRAINED CONCRETE</u>	150
10.6.15	<u>CURING OF CONCRETE</u>	151
10.6.16	<u>JOINT FILLER AND SEALANT</u>	151

10.6 **CONCRETE**

10.6.1 **Mixes and Quality**

Concrete mixes may be Designed, Designated, Prescribed, Standardized or Proprietary and shall conform to the requirements of BS EN 206-1 and BS 8500-1.

Concrete design mixes must be submitted to the Engineer for approval.

Note	<p>Concrete Exposure classes</p> <p>The Developer is required to determine the exposure classes of all concrete. Exposure classes for concrete shall be selected from tables A.1 and A.2 of BS 8500-1. Where chemical attack of buried concrete needs to be considered then the aggressive chemical environment for concrete (ACEC-class) shall be selected from table A2 of BS 8500-1 and converted to a design chemical class (DC-class) and, where appropriate the number of additional protective measures (APM's) using table A.3 and A.4 of BS 8500-1.</p>
-------------	--

10.6.2 **Structural Concrete**

Concrete which is to be used for structural work (bridges, headwalls, etc) shall comply with the requirements of the Specification for Highway Works 1700 – Series or with the Water Association Sewers for Adoption specification.

Testing of fresh and hardened concrete for structural work shall be in accordance with clause 1707 – Concrete Conformity of the Specification of Highway Works.

The Engineer may at any time increase the testing rates of both fresh and hardened concrete to ensure the finished structure is of an acceptable standard for adoption. The Engineer may use the results obtained from such testing to accept or reject the fresh or hardened concrete.

10.6.3 **Concrete Grades**

Table 10.6.1 gives examples of concrete grades.

TABLE 10.6.1

DESIGNATED MIXES	STANDARD PRESCRIBED MIXES	CHARACTERISTIC COMPRESSIVE CUBE STRENGTH (N/mm ²)
GEN 0 GEN1 GEN2 GEN3	ST1 ST2 ST3 ST4	8 10 15 20
FND (all designations)		35
PAV1 PAV2		30 35
RC25 RC30 RC35 RC40 RC45 RC50 RC 50XF		25 35 35 40 45 50 50

TABLE 10.6.2

APPLICATION	DESIGNATED CONCRETE	STANDARDISED PRESCRIBED CONCRETE	RECOMMENDED CONSISTENCE CLASS
Foundations requiring DC-1 concrete	GEN 1	ST2	S3
Blinding & Mass Concrete fill	GEN 1	ST2	S3
Strip footings	GEN 1	ST2	S3
Mass concrete foundation	RC30	Not any	
Trench fill foundations			
Fully buried reinforced foundations			
General applications			
Kerb bedding and backing	GEN 0	ST1	S1
Drainage works to give immediate support	GEN 1	ST2	S1
Other drainage works	GEN 1	ST2	S1
	GEN2	ST2	S3
Paving			
House drives	PAV1	-	S2
Domestic parking	PAV1	-	S2
External parking	PAV1	-	S2
Heavy duty external paving with rubber tyre vehicles	PAV2	-	S2

Table 10.6.2 gives guidance of the selection of designated and standardised prescribed concrete in various applications (for the full guidance see BS 8500 – Table A.7)

10.6.4 **Constituent Materials of Concrete**

(i) **Cement**

Cement shall comply with the requirements given in Table A.17 of BS 8500 – 1.

The use of rapid hardening cement to allow early trafficking of the concrete requires the approval of the Engineer.

(ii) **Aggregates**

Aggregates shall conform with the list give in clause 4.3 of BS 8500 except that recycled concrete aggregates and recycled aggregates are not permitted within concrete mixes intended for structural use.

(iii) Water

Only water from a water company supply shall be used.

(iv) Admixtures

No admixture other than an air-entrained admixture, where specified, complying with BS EN 934.2 shall be incorporated in the concrete without specific written agreement of the Engineer.

Plasticisers or water reducing admixtures, where permitted by the Engineer, shall comply with BS EN 934.

Admixtures containing calcium chloride shall not be used.

(v) Chloride content

The limits of chloride content of the concrete shall be as given in clause 5.2.7 and table 10 of BS EN 206.

(vi) Control of Alkali – Silica Reaction

The Developer shall ensure that the concrete producer takes action to minimize the damaging effect of alkali-silica-reaction by applying one of the sets of conditions given in 5.2 of BS 8500-2.

10.6.5 Properties of Fresh Concrete

(i) Consistency

For normal concrete mixes the consistency of the concrete will be low to medium corresponding to a target slump value of 50mm to 75mm respectively.

Where a high consistency concrete is required (e.g. concrete section containing congested steel) then the target slump can be as high as 125mm with the approval of the Engineer.

Note(a) Consistency classes and target values are given in BS EN 206-1 clause 4.2 Table 3 and clause 5.4 Table 1 respectfully.

Note(b) The consistency of designed mixes for structural use shall be selected by the Developer with regard to the method of placement, congestion of steel within the framework, surface finish specified and method of compaction employed.

The consistency selected for each different mix shall be approved by the Engineer before concrete placement operations commence.

(ii) Consistency at delivery

The addition of water or admixtures is not permitted to the mix during transit or on site.

(iii) Air Content

Limiting values for the composition and properties to resist freezing and thawing (XF exposure) are given in BS 8500-1 table A.14. The values given in table A.14 are minimum values for entrained air related to exposure class and aggregate size.

The minimum air entrained content manufactured with 20mm aggregate size is 3.5% with a maximum air content of 7.5%.

10.6.6 Ready Mixed Concrete

(i) Manufacture

Concrete shall be batched and mixed in accordance with BS EN 8500.

The Developer shall afford all reasonable opportunity and facility to the Engineer to inspect the constituent materials and the manufacture of the concrete and if required to take samples.

(ii) Changes in materials and/or mix composition

The Developer shall inform the Engineer of any proposed changes in the source of nature of any of the mix constituents and any changes in mix composition which can affect the requirements of the hardened concrete.

Any such changes shall not take the cement content, water: cement ratio or chloride content outside the specified limits or increase the risk of ASR.

(iii) Transport and Delivery

Concrete shall be transported in purpose-made truck mixers except in special circumstances, where the Engineer may permit delivery by other types of delivery vehicle.

All such special circumstances shall be agreed with the Engineer before concrete delivery commences.

10.6.7 Formwork

The Developer shall provide all necessary formwork, which shall be thoroughly cleaned and coated with an approved material to prevent adhesion of fresh concrete and set so as to ensure that there is no loss of material.

Formwork shall only be struck when the concrete has attained adequate strength and with the approval of the Engineer.

Note Adequate strength shall be determined by site curing at least one test cube in the same environmental conditions as the concrete. The compressive strength of the cube shall not be less than 40% of the characteristic compressive strength before the formwork is removed.

10.6.8 Placement

The concrete must be placed and compacted within two hours of the introduction of water to the cement/aggregate.

Concrete shall not be dropped into place from a height exceeding 1.3m. It shall be placed so that there is no contamination, segregation, or loss of the constituent material or displacement of any reinforcement. Compaction is to be complete within 30 minutes of discharge from the mixer.

Fresh concrete shall not be placed against concrete which has been in position for more than 30 minutes, without the approval of the Engineer. When concrete has been placed for more than 2 hours, no further concrete shall be placed against it for another 24 hours.

The Developer must submit proposals to the Engineer for approval before any further concrete pour takes place.

Concrete must not be placed in flowing water.

10.6.9 Cold Weather Working

Concreting at ambient temperature below 2°C may only be carried out with the agreement of the Engineer and if the following conditions are met:-

- (i) the aggregates and water used in the mix are free from snow, ice and frost
- (ii) any formwork, reinforcement and surface with which the concrete will be in contact are to be free from snow, ice and frost and be at a temperature above 0°C.
- (iii) the temperature of the concrete at the time of placing shall not be less than 5°C.
- (iv) the temperature at the surface of the concrete must be maintained at not less than 5°C measured at any location until the concrete strength reaches a strength of 5 N/mm² as confirmed by test cubes cured under similar conditions.
- (v) where required thermal insulation blankets are employed immediately after placing and finishing the concrete and shall be retained in place for a minimum of 3 days or until the concrete has reached 50% of the specified characteristic compressive strength.

10.6.10 **Compaction**

All concrete shall be compacted to produce a dense homogeneous mass.

Unless otherwise agreed by the Engineer it shall be compacted by using vibrators and a sufficient number should always be on site as replacements in case of breakdown.

Where immersion type vibrators are used, contact with reinforcement and all inserts is to be avoided. Care must be taken not to over vibrate the concrete and cause segregation, or damage to work that has set. This compaction must be completed within 2 hours of the addition of water.

Concrete must not be further vibrated after compaction.

10.6.11 **Sampling and Testing**

All sampling, curing of cubes and testing of concrete, fresh and hardened, shall be carried out in accordance with the requirements of the specifications BS 12350 and BS 12390.

Note (a) Sampling shall take place at the point of delivery into the construction unless otherwise agreed by the Engineer.

10.6.12 **Defects in Concrete**

Any defects which in the opinion of the Engineer may be detrimental to the safety and/or durability of the concrete construction, may be rejected even if satisfactory test results have been obtained.

Minor surface defects may be made good subject to the Engineer's approval. Any remedial works carried out with the Engineers approval may be liable to rejection as defective work.

10.6.13 **Reinforcement for Lay-bys**

The reinforcement may be steel mesh or fibre reinforcement.

Steel mesh reinforcement shall comply with the requirements of BS 4483 and shall be free from oil, dirt, rust and scale. The reinforcement shall be placed with 60mm+/-10mm cover from the finished surface.

The reinforcement shall terminate 125mm+/-25mm from the slab edges and terminate 300mm+/-50mm from the transverse joint.

Where fibre reinforcement is to be used then the Developer shall inform the Engineer of the type, size and dosage rate.

For typical details see Sketches 10.6.1 and 10.6.2.

10.6.14 **Air-Entrained Concrete**

Air-entrained concrete shall satisfy all of the specification requirements for the

pavement grades (PAV1 & PAV2) in Table 10.6.1.

Unless otherwise permitted by the Engineer, the fine aggregate used in the production of air-entrained concrete shall be uncrushed natural sand complying with the requirements of BS EN 12620.

The air-entrainment agent shall be added at the batching plant and its volume noted on the delivery ticket.

10.6.15 **Curing of Concrete**

Immediately on completion of the placing and compaction, the concrete shall be cured i.e. protected against the harmful effects of weather, including rain, rapid temperature changes, and frost and from drying out. The method of curing shall provide a suitable environment for the concrete to mature and prevent harmful loss of moisture.

The concrete shall be cured for a minimum period of 7 days unless otherwise agreed by the Engineer.

The use of all curing liquids, compounds, membranes and methods used shall be submitted to the Engineer in writing for approval and shall not be employed until approval is given.

During the curing period the concrete shall be protected from use by traffic or any other form of loading which may adversely affect its future performance.

10.6.16 **Joint filler and Sealant**

For concrete lay-bys the joint fillers shall be pre-formed and of an approved quality. Joint sealants shall be either hot or cold poured, or pre-formed. Whichever method is used it must be approved by the Engineer.

If poured sealants are used any spillage or surplus must be removed to the satisfaction of the Engineer.

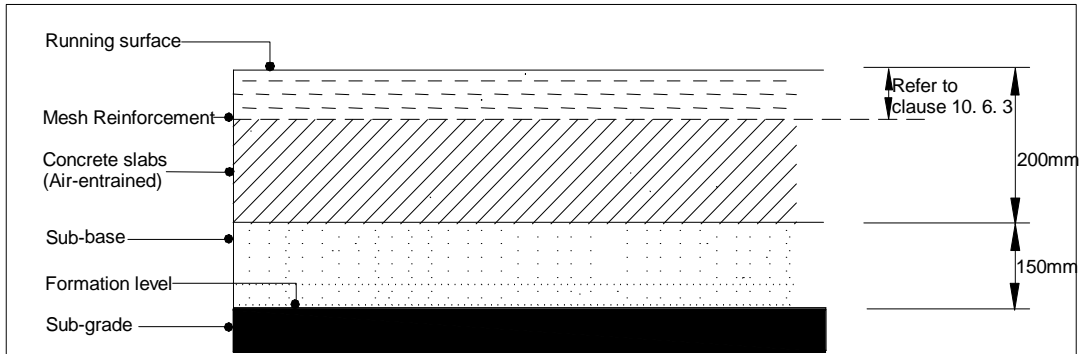

TERMINOLOGY SECTION

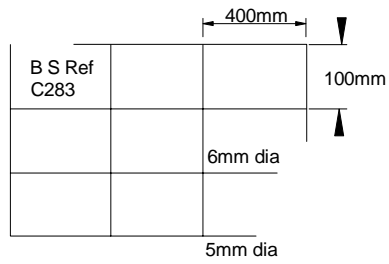
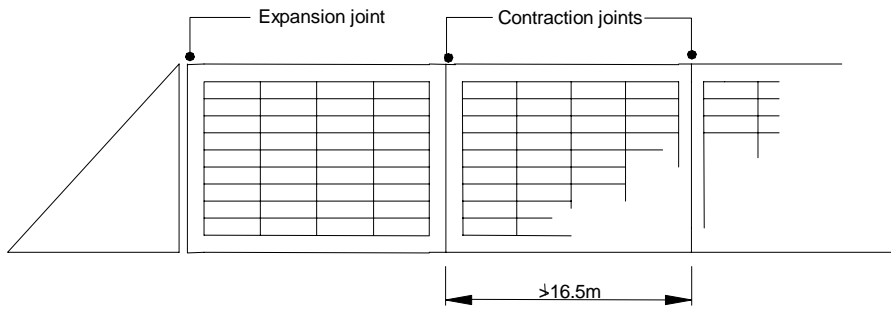

MESH JOINTS (PLAN)

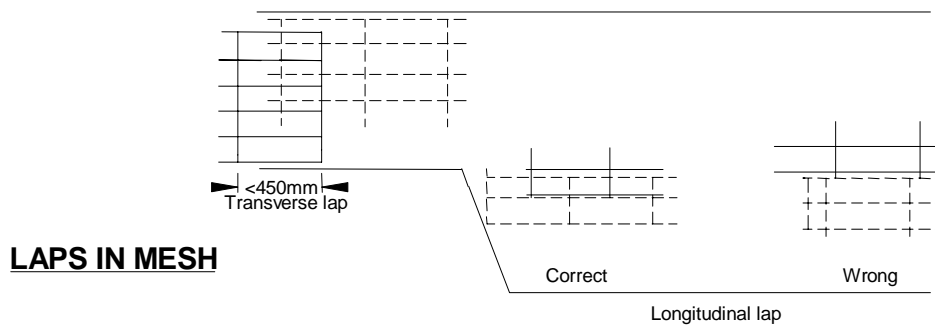

LAPS IN MESH

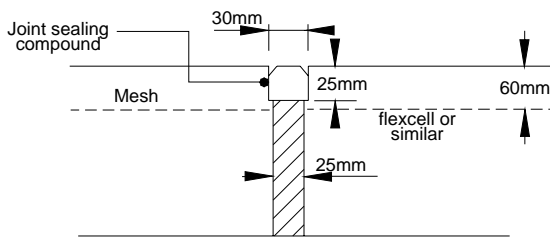

EXPANSION JOINT

EXPANSION JOINT WITH DOWEL

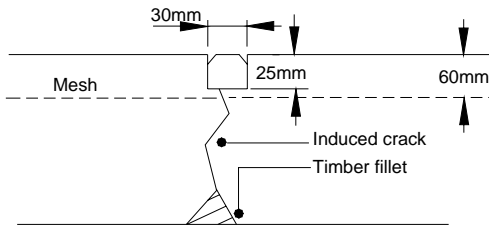
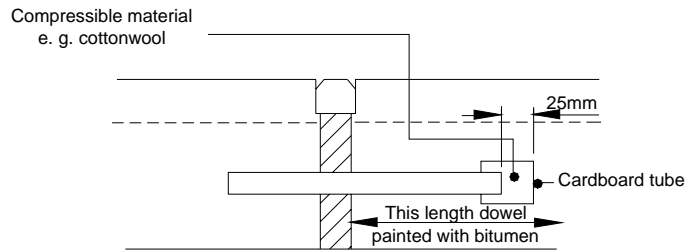

CONTRACTION JOINT

CONSTRUCTION JOINT

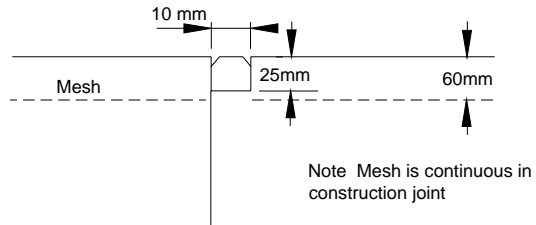

Note Mesh is continuous in construction joint

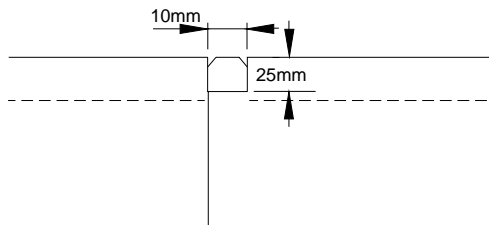

LONGITUDINAL JOINT (TIES BARS TO BE USED)

Sketch No 10. 6. 2

CONTENTS

<i>CLAUSE</i>	<i>TITLE</i>	<i>PAGE</i>
10.7.1	<u>QUALITY ASSURANCE SCHEME FOR THE PRODUCTION OF BITUMINOUS MATERIALS</u>	155
10.7.2	<u>ALTERNATIVE MATERIALS</u>	157
10.7.3	<u>AGGREGATES</u>	158
10.7.4	<u>BITUMINOUS BINDERS</u>	158
10.7.5	<u>BITUMINOUS SPRAYS</u>	159
10.7.6	<u>COLD RECYCLED BITUMEN BOUND MATERIAL (FOAMIX)</u>	159
10.7.7	<u>PRE-COATED CHIPPINGS</u>	160
10.7.8	<u>SHARED SURFACES AND CYCLEWAYS</u>	161
10.7.9	<u>ADJUSTMENT OF MANHOLE COVERS</u>	161
10.7.10	<u>TYING INTO EXISTING WORK</u>	161
10.7.11	<u>SURFACE LEVEL TOLERANCES</u>	161
10.7.12	<u>TRANSPORTING</u>	162
10.7.13	<u>LAYING</u>	163
10.7.14	<u>ADVERSE WEATHER</u>	164
10.7.15	<u>COMPACTION REQUIREMENTS</u>	164
10.7.16	<u>SURFACE REGULARITY</u>	164
10.7.17	<u>RECTIFICATION DUE TO NON-COMPLIANCE</u>	165
10.7.18	<u>SEALING GRIT</u>	166

10.7 BITUMINOUS MATERIALS

10.7.1 **Quality Assurance Scheme for the Production of Bituminous Materials and Laying of Bituminous Materials.**

All contractors used in the supply and laying of bituminous materials for roads and footways shall be accredited under the following UKAS sector schemes

- Sector Scheme 14 - For the quality assurance of the production of asphalt mixes
- National Highways Sector Schemes for Quality Management in Highway Works 16 for the laying of asphalt mixes

Details of these schemes can be found on the UKAS web site

http://www.ukas.com/information_centre/publications.asp

The developer must, prior to the commencement of surfacing activities, submit for approval, the proposed contractor along with a copy of the Certificate of Accreditation under the UKAS Sector 16 scheme.

The details of any supplier of materials must also be submitted at the same time, together with a copy of the suppliers Certificate of Accreditation under the UKAS Sector 14 scheme.

Contractors who are not accredited by either of the above schemes must gain the permission of the Engineer prior to commencement of any bituminous surfacing works. Any contractor who is not Accredited under the UKAS sector schemes, must submit as part of the request for a deviation, a quality plan which will assure the competence of the laying operation and the quality of the materials to be used.

The term asphalt is the generic term now employed throughout the E.C. for all mixtures of mineral aggregate, including filler, and a bituminous binder. For simplicity however and to match our existing specification the term bituminous materials have been retained.

Only those bituminous materials manufactured by plants which hold accreditation from and comply with the requirements of THE NATIONAL THIRD – PARTY QUALITY ASSURANCE SCHEME FOR THE PRODUCTION OF BITUMINOUS MATERIALS (the SCHEME) shall be used in the permanent works.

(The SCHEME has been jointly developed by the County Surveyors Society, Highways Agency and BACMI)

Before the supply of any bituminous materials the Developer shall submit to the Engineer documented evidence that all primary and secondary support plant/s proposed by the Contractor from which supplies are to be delivered have been assessed under the terms of Part 1 of the Scheme and that the plants operate at a Quality Level of Q6 or better.

Where a plant is classified as having a Quality Level of Qx, assessed in accordance with the criteria given in clause 6.2 (iv) of the Scheme, then material from the plant will not be acceptable within the permanent works without the permission of the Engineer.

Note:- A plant shall be classified as having a Quality Level of Q_x only when the 14 day action period fails to re-establish a Q level of Q₆ or better. During the 14 day action period the plant shall be deemed to have an acceptable Q level for delivery.

The Developer shall appraise the Engineer of any change in the quality status of any plant at the earliest opportunity.

Where the supply of bituminous materials is for a period of more than 7 continuous supply days then the Developer shall submit to the Engineer the weekly Q level for each plant/s used over the full supply period.

After any interrupted supply of more than 7 supply days then the Developer shall submit to the Engineer the plant/s Q level before supply re-commences.

The Engineer may at any time during the supply perform audit checks on the material as delivered to site.

These audit checks will be at any frequency as decided by the Engineer and may be any combination of the following:-

- Suitability of delivery vehicles
- Organoleptic checks of material in the body of the vehicle and on discharge into the paver or stockpile
- Temperature
- Compositional analysis
- Hot sand test for coated chippings

Where any of the Engineers audit checks indicate non-compliance to specification then the Engineer shall be afforded the right to audit the plant and all documentation / results as are required to be obtained for that supply under the Scheme.

The Engineers audit checks, with the agreement of all parties, may be used, in combination with the plant results, to calculate the Q level of the supply plant.

The Developer shall ensure that as part of the Producers quality plan where plant inspection and testing of the finished material as performed by the Producer shows non-conformity then the Developer is informed without delay.

It shall be the responsibility of the Developer to ensure that the Engineer is appraised of this information at the earliest opportunity.

Failure to inform the Engineer will risk having the material removed and plant approval withdrawn until the cause of the communication breakdown has been identified and rectified to the satisfaction of the Engineer.

General compliance with the SCHEME does not prejudice the right of the Engineer to reject any material found to be unsuitable for the works or falling into Category C as described by the SCHEME.

Note 1 For shared surfaces and cycletracks which require a “red” bituminous wearing course see Clause 10.7.7.

Note 2 The use of slag based materials must be in accordance with Clause 10.1.5

TABLE 10.7.1

MACADAM MIXES BS 4987	NOMINAL AGGREGATE SIZE mm	NORMAL LAYER THICKNESS mm	BS 4987 CLAUSE NUMBER
Heavy Duty Base Road Base	0/32	70 – 120	5.2
Dense Base Road Base	0/32	70 – 120	5.2
Heavy Duty Binder Course	0/20	50 – 80	6.5
Dense Binder Course	0/20	50 – 80	6.5
Close Graded Surface Course	0/14	40 – 55	7.3
	0/10	30 – 35	7.4
Dense Surface Course	0/6	20 – 30	7.5
Fine (Sealing Grit)	0/3	15 – 25	7.7

TABLE 10.7.2

ASPHALT MIXES	% STONE CONTENT AND NOMINAL SIZE mm	NOMINAL LAYER THICKNESS mm
Base Road Base	60%, 0/32	70 – 150
Binder Course	60%, 0/20	45 – 80
Regulating Mixtures	60%, 0/20	45 – 80
	60%, 0/14	35 – 50
	60%, 0/10	20 – 35
Wearing course	30%, 0/14	40

Rolled asphalt surface course mixtures shall be of the design mix type F and shall be designed in accordance with the requirements given in B.S. 598 : Part 107. The design procedure shall be used to select a target binder content. The composition shall comply with the requirements of table 3 of B.S. 594 : Part 1. All such designs will require the approval of the Engineer.

Stability and flow requirements for rolled asphalt wearing course for the complete mix at the target binder content shall be as follows:—

1. Stability – 4kN minimum to 10kn maximum.
2. Flow – 5mm maximum

The above design requirements shall be verified using materials obtained from the plant and shall be carried out either by the supplier and witnessed by the Engineer or by a laboratory approved by the Engineer.

10.7.2 Alternative Materials

Where the Developer is required by Clause 5.2.7 to produce a surface course material which, when laid, will have increased skidding resistance value, then alternative materials having a skidding resistance value equivalent to that of hot

rolled asphalt surface course, with coated chippings, refer to clause 10.7.6 must be submitted to the Engineer for approval. All such submissions shall include information on coarse aggregate rock type, aggregate source, polished stone value (PSV), aggregate abrasion value (AAV), binder penetration and softening point, any binder modifiers and grading limits of the aggregates if different from equivalent mixtures given in B.S. 4987 and any other information the Engineer may require.

10.7.3 **Aggregates**

Rock belonging to the limestone group or blast furnace slag must not be used in the manufacture of surface course macadam mixtures.

The minimum polished stone value (PSV) of the coarse aggregate for asphalt surface course mixtures shall be 50.

Aggregates for bituminous mixtures shall comply with the requirements of BS EN 13043.

All aggregates shall be clean, hard and durable and not contain any material, which can prevent proper coating or effect the durability of the mixed materials.

(i) Hardness

Coarse aggregates for bituminous materials shall be in accordance with recommendations given in BS EN 13043.

(ii) Durability

The aggregate source shall be tested in accordance with BS EN 13043 4.2.9.2 and shall have a soundness value no greater than MS25.

Note The soundness value of an aggregate source, need only be determined and submitted to the Engineer on an annual basis. Thereafter, for routine testing of such aggregates, the water absorption value shall be used as determined by the method given in BS EN 13043. If the water absorption value of the coarse aggregate is greater than 2% for natural aggregates and 4% for blast furnace slag, then the aggregate source is to be re-tested for soundness as given above.

(iii) Cleanness

The fraction of material passing a 63µm sieve for coarse or fine aggregates shall not exceed the limits given in BS EN 13043 4.1.4. Table 6.

10.7.4 **Bituminous Binders**

The binder shall comply with those listed in Section 2, Clause 2.1 of B.S.594 : Part 1

Note The normal shall be penetration grade 50, binder number 3 of Table 1 of B.S. 594 : Part 1

Dense and Heavy Duty Macadam Mixtures

The binder grades shall be as given below:-

Machine laid materials

(a) Dense Macadam – 125 pen. Heavy Duty Macadam – 50 pen.

Penetration grade bitumen of 190 pen. may be used in machine laid with the approval of the Engineer

Note - The use of 190 pen materials will result in increased layer thickness and requires the Engineer's approval.

No fluxing or volatile oils shall be permitted in the manufacture of machine laid materials

Where Dense or Close Graded Surface Course materials are to be laid between the 1st June and the 1st October, the binder shall be 50 pen with a 3% addition of Sasol Wax. This applies to both Footways and Highways. Alternatives will only be permitted with the prior approval of the Engineer.

(b) Hand laid materials

Between the 1st June and 1st October, the binder shall be 50 pen with an addition of 3% Sasol Wax.

Dense and close graded macadam – 125 pen / 190 pen

Note - It is preferable to use penetration graded bitumen for all works, however substantial advantages can be gained from using cut-back bitumen in footpath locations which are hand laid and therefore binder viscosity of 200 secs may be permitted in these areas with the approval of the Engineer.

10.7.5 Bituminous Sprays

A tack coat shall be applied to all surfaces more than 24 hours old or to any surface less than 24 hours old which in the opinion of the Engineer requires treatment.

The tack coat shall be a bituminous emulsion complying with Class K1 – 40 of B.S. 434 : Part 1 applied at a uniform rate of spread over the whole of the surfacing to be covered.

The emulsion shall not be allowed to collect in hollows and shall be allowed to “break” before being overlaid.

If the Engineer requires proof that adhesion exists between layers then 150mm diameter core samples shall be taken at locations indicated by the Engineer.

10.7.6 Cold Recycled Bitumen Bound Material (Foamix)

Foamix macadam is a specialist material which is produced from recycled, pulverised and graded aggregates mixed with a foamed bitumen to give a macadam type mix for use as a base (road base) and / or binder course. The bitumen, normally of 125 pen, is foamed prior to mixing with the aggregate.

Foamix shall only be used as a base (road base) and / or binder course and requires approval of the Engineer prior to installation. Approval will require a Quality Assurance Document from the supplier incorporating the requirements given in BS EN 9001 and shall cover the following:

- a) Design Procedure
- b) Control of Production
- c) Component materials including any filler / adhesion agents used
- d) Base bitumen
- e) Process control including production testing
- f) Control of non-conforming product

- g) Advice on laying and compaction
- h) In-situ testing control parameters.

The minimum acceptable design and characteristic requirements shall be given in the Specification for Highway Works, Clause 948, Table 9/15. The compliance criteria for process control shall be as given in the Specification for Highway Works, Clause 948, Table 9/11.

The compaction achieved on site shall be measured using an approved gauge and shall be continuous throughout the laying process. Information from the supplier on refusal density to enable in-situ densities to be measured shall be supplied to the Engineer for each days delivery.

Indirect tensile stiffness modulus (ITSM) shall be carried out on each days production and the information shall be supplied to the Engineer. Testing shall be in accordance with the requirements given in the Specification for Highway Works, Clause 948. Where ITSM results indicates non-compliance then an investigation in accordance with the Engineer's requirements shall be performed by the supplier. Remedial action, if required, shall be determined by the Engineer related to the findings of the investigation.

10.7.7 Pre-Coated Chippings

Requirements for the supply, use and application of chippings shall be as stated in BS 594 : Parts 1 and 2 with the following additional requirements:-

When using hot rolled asphalt surface course the surface roughness shall be obtained by using pre-coated chippings. The method of application of the coated chippings shall be in accordance with the requirements of BS 594 : Part 2 : Section 7.

The chippings shall be clean and free from any contamination which may prevent permanent retention in the asphalt.

The maximum aggregate abrasion value of the chippings shall not exceed 12 and the minimum polished stone value is to be 60 unless otherwise specified by the Engineer.

The chippings shall be applied to the rolled asphalt surfacing by a mechanical chipper unless otherwise agreed by the Engineer.

The chippings shall be applied at a uniform rate to give an even distribution throughout the whole of the surface to be covered.

10.7.8 Shared Surfaces and Cycleways

The surface course material is to be of a red colour. Coloured bituminous materials by their nature are proprietary materials and are not covered by either BS 4987 (macadam) or BS 594 (asphalt) and therefore the constituent materials requirements shall be devised by the supplier to ensure a product that will give adequate durability. The one exception is that the aggregate is to be red from a source approved by the Engineer.

The transporting, laying and compaction shall be generally in compliance with the requirements of BS 4987 or BS 594 and also the requirements of this specification. Where the supplier of these proprietary materials requires other specialist operations then they shall be followed.

The Developer shall submit to the Engineer the proposed supplier and the following minimum information of the proposed mix:-

- (i) the composition of the mix with compliance specification limits for binder content and grading.
- (ii) binder penetration and any binder modification.
- (iii) coarse aggregate source
- (iv) fine aggregate source

Where the supplier wishes to change any of the constituent components of the approved mix they must be submitted to the Engineer for approval.

All vertical joints must be treated with red bitumen or red bitumen emulsion.

Note:- It is recommended that those involved in the laying of red pigmented bituminous materials seek advice on acceptable laying practices from the supplier of such material before work commences on site. This is to aid the safety of the cycleway.

10.7.9 Adjustment of Manholes Covers

The Developer shall be responsible for the adjustment of all manhole covers, hydrants, service boxes and road gullies to suit the finished road level prior to the laying of the surface course.

Any part of these covers against which surfacing material is to be laid shall be cleaned and treated with hot bitumen or emulsion to the satisfaction of the Engineer.

10.7.10 Tying into Existing Work

Where new work abuts onto or ties into an existing carriageway the surface of the existing shall be scarified over a minimum length of 2m adjusted and re-shaped as directed by the Engineer to comply with new camber and/or crossfalls. See Clause 10.7.12 for jointing requirements.

10.7.11 Surface Level Tolerances

The permitted deviation of the surface level of any pavement layer at any point from the true surface level shall not exceed the following values:-

- (a) sub-base to receive base road-base +0mm /-30mm
- (b) base (roadbase) to receive binder course +/- 15mm
- (c) binder course to receive surface course +/- 6mm
- (d) binder course to receive surface course on areas other than roads e.g. car parks, playgrounds +/- 10mm
- (e) surface course + / - 6mm

The sum of the deviations in the levels of different pavements layers shall not result in a reduction of the required design thickness by more than 8.5% or in the overall surface course thickness by more than 5mm.

10.7.12 **Transporting**

Bituminous material shall be carried in clean insulated vehicles and shall be covered by double sheets until tipped. The use of dust, coated dust or sand on the interior of the vehicles to help in the discharge of the material is allowed but must be kept to a minimum, with any excess removed prior to loading. Refer to Table 10.7.3 for maximum delivery temperatures.

TABLE 10.7.3

PENETRATION GRADE	MACADAM TYPE	MAXIMUM TEMPERATURE AT ANY STATE (°c)
290	Dense/close graded	130
190		150
125		160
50		190

Bituminous materials shall, on delivery to site, be fully and uniformly coated.

All bituminous materials shall be manufactured, transported, laid and compacted without segregation of the aggregates, separation of the binder and cracking / tearing of the layer.

Where any or all of these conditions occur and in the opinion of the Engineer they could adversely affect the performance of the construction then the material shall be removed and replaced.

Note (a) Removal of bituminous materials shall be full width and depth of the layer concerned by a length to permit replacement by machine laying.

Note (b) Where longitudinal joints are sealed in surface course or “overbanded” then the Developer should be aware of the following safety requirements :-

Where joint sealing / overband widths exceed 20mm then the wet skidding resistance value (SRV) shall be not less than 55 when measured using the portable skid-resistance tester. (Applied bitumen has wet SRV of approximately 20).

The width of any applied material shall not exceed 40mm with a thickness of not greater than 3mm.

TABLE 10.7.4

TYPE	GRADE	MAXIMUM TEMPERATURE AT ANY STAGE		MINIMUM DELIVERY TEMPERATURE (°C)	MINIMUM ROLLING TEMPERATURE (°C)
		BASE (ROADBASE)/ BINDER COURSE (°C)	SURFACE COURSE (°C)		
Bitumen	50 pen	170	185	130	85

10.7.13 **Laying**

The material, shall as soon as possible after arrival on site, be supplied continuously to an approved self-propelled paver, laid without delay and spread levelled and tamped.

The rate of travel of the paver and its method of operation shall be adjusted to ensure an even and uniform flow of material across the full laying width, freedom from dragging or tearing of the material and minimum segregation.

All joints in the surface course must be cut back to a vertical face for the depth of the layer.

A cutting blade attached to a roller must be used for all longitudinal joints. For the surface course the vertical face of the joint must be coated with a hot bitumen or emulsion to the satisfaction of the Engineer.

The laying of material shall not commence until the rollers and their operators are at the place of laying and ready to commence compaction. Surface cracking due to poor rolling technique will result in the rejection of the material by the Engineer.

Alternatively the material may be laid by using pavers operating in echelon provided they are in close proximity for adjacent widths to be fully compacted by continuous rolling.

Hand laying of material will only be allowed with the permission of the Engineer and only in small areas.

All joints must be set at least 300mm from parallel joints in the layers beneath.

The base (road base) material shall not remain uncovered by either the binder course, or surface treatment for more than 3 consecutive days and only construction traffic will be allowed on the carriageway during this time. (See also Clause 10.7.5).

The vertical faces of manholes, gullies, kerbs and channels and similar projections against which bituminous material is to be laid shall be cleaned and painted with a hot bitumen or emulsion to the satisfaction of the Engineer.

Rollers shall not stand on newly laid material whilst there is a risk that it may deform. Any such deformed areas will be rejected, removed and replaced to the satisfaction of the Engineer.

10.7.14 Adverse Weather

Laying operations shall cease while there is freestanding water on the surface to be covered and during periods of rain if in the opinion of the Engineer the conditions are likely to be detrimental to the performance of the bituminous surfacing.

Bituminous materials shall not be laid on any surface, which is frozen or covered with ice or snow.

Laying shall cease when the air temperature reaches 0°C on a falling thermometer. However with the Engineer's approval in calm conditions, laying may continue until the air temperature reaches -3°C on a falling thermometer.

Laying may proceed, with the Engineer's permission, when the surface to be covered is dry and free from ice at air temperatures at or above -1°C on a rising thermometer.

10.7.15 Compaction Requirements

Compaction shall be carried out as given in BS 4987 : Part 2 : Section 6 for macadams and BS 594 : Part 2 Section 8 for asphalts including all notes with the following additional requirements:-

- (i) The use of vibrating rollers will not be permitted for the compaction of any bituminous surface course laid in the carriageway.
- (ii) Material shall be compacted as soon as rolling can be effected without causing undue displacement of the mixed material and while this has at least the minimum rolling temperature stated in Table 10.7.5 for macadams and Table 10.7.4 for asphalts.
- (iii) The material shall be rolled in a longitudinal direction from the sides to centre of the carriageway, overlapping on successive passes by at least half width of the rear roller and with the driven rollers nearest to the paver.
- (iv) Adequate compaction shall be carried out to obtain full strength in each layer.

Note (a) The Engineer will ensure that adequate compaction has been achieved by checking the compacted density by use of a Nuclear Density Meter. This check must be carried out before the surface course is laid and will be based on having first established (before work commences) a site target density by agreement with the supplier. The finished compacted density shall be not less than 90% of this established site target density. Failure to comply with this requirement will result in the material being rejected.

Note (b) In the case of disputes the Engineer will require that the Developer carries out the End Result Compaction test as given in Section 6 Clause 6.4 of BS 4987 : Part 2 using a full percentage refusal density method (PRD) with the exception that the acceptance requirements will be that a site density of not less than 90% of the refusal density be achieved. The cost of this testing must be borne by the Developer.

10.7.16 Surface Regularity

Should the Engineer decide that there is a need to check the longitudinal regularity of any of the bituminous layer the checking procedure detailed in the Department of Transport Specification for Highway Works – Section 702 shall be followed to check longitudinal regularity and a 3m straightedge used to check transverse regularity.

Irregularities shall not exceed 5mm for surface course, 10mm for binder course and 14mm for base (road base) materials.

TABLE 10.7.5

Annex A (informative)

Recommended delivery and rolling temperatures for coated macadam.

The recommended delivery and rolling temperature for coated macadam are shown in Table A.1

Table A.1 – Recommended delivery and rolling temperatures for coated macadam other than dense, heavy duty and high modulus binder course and base (road base) macadam

TYPE OF MIXTURE INCLUDING BINDER TYPE AND GRADE		MINIMUM TEMPERATURE OF MIXTURE IN LORRY WITHIN 30 AFTER ARRIVAL ON SITE °C	MINIMUM TEMPERATURE IMMEDIATELY PRIOR TO ROLLING °C
<i>Bitumen</i> Dense, close graded, medium graded surface course and fine graded	250/330 pen	100	80
	160/220 pen*	110	85
Dense and close graded surface course	100/150 pen	120	95
Open course and single course	250/330 pen	85	65
	160/220	95	75
Porous asphalt	160/220 or 100/150 pen	110	85
NOTE 1	See Table 8 for temperatures of dense, heavy duty and high modulus binder course and base (road base) macadam.		
NOTE 2	Fluxed and deferred set mixtures (see BS 4987 – 1 : 2003, Annex A) may be delivered/rolled at lower temperatures than those in this table.		
*	For slag macadam, temperatures 10°C lower than those recommended may be used.		

10.7.17 Rectification Due to Non-Compliance

Where any carriageway does not comply with the Specification for regularity, layer thickness, texture depth, material properties or compaction, the full extent of the area which does not comply shall be rectified in the following manner:-

(i) Binder Course and Base (Road Base) Materials

These materials shall have the full depth of the course removed and replaced with fresh material laid and compacted in accordance with the Specification. The area to be re-laid shall be at least half the carriageway width and a minimum 15m long.

(ii) Surface Course Materials

The rectification shall be as above

Note Where defects in surface course entail more than one remedial area and these areas if carried out as separate patches would, in the opinion of the Engineer, affect the safety or durability of the surface course the Engineer may require these remedials be combined to give one large rectified area thus avoiding a “patchwork” effect.

10.7.18 Sealing Grit

If the surface course is not to be laid within 3 days then sealing grit must be applied to the binder course layer.

Sealing grit shall comply with BS 4987 – Clause 7.9.

CONTENTS

<i>CLAUSE</i>	<i>TITLE</i>	<i>PAGE</i>
10.8.1	<u>GENERAL</u>	168
10.8.2	<u>CONSTRUCTION OF CONVENTIONAL PAVEMENTS</u>	169
10.8.3	<u>EDGE RESTRAINTS</u>	169
10.8.4	<u>INSTALLATION OF SURFACE COURSE (LAYING PAVERS AND BLOCKS)</u>	169
10.8.5	<u>COMPACTION OF PAVING UNITS INTO THE LAYING COURSE</u>	170
10.8.6	<u>SURFACE REGULARITY</u>	171
10.8.7	<u>SEALING OF THE PAVEMENT</u>	171
10.8.8	<u>ADVERSE WEATHER CONDITIONS</u>	171
10.8.9	<u>RECESSED COVERS</u>	171

10.8 BLOCK PAVING FOR CARRIAGEWAYS

10.8.1 General

Block paving shall be of the conventional pavement type and restricted to pedestrian areas including footpaths and to Category 5 roads (see section 5).

For other uses approval is required from the Engineer

Note – to ensure the successful use of block paving the Developers attention is drawn to British Standard BS7533. This British Standard gives guidance on the minimum design considerations and minimum standards for construction which the Engineer will expect to be followed for areas offered for adoption. The terms and definitions given in BS7533 are used throughout this section.

(i) Paving Units (blocks)

Concrete paving blocks shall comply with the requirements given in BS EN 1338 and shall have the following performance requirements.

- a) Weathering requirements – all blocks shall be of class 3.
- b) Abrasion requirements – all blocks shall be class 3
- c) Slip resistance – blocks for predominately pedestrian use shall have, at the time of installation, a wet slip resistance when measured in accordance with BS 7976 of not less than 50.
- d) Skidding resistance – blocks for vehicular areas shall have, at the time of installation, a wet skidding resistance when measured in accordance with BS 7976 of not less than 55.

Note – Prior to the use of the proposed paving units the Developer is required to supply to the Engineer a certificate of conformity showing compliance to the above minimum requirements. In case of dispute then Audit / Compliance testing shall be in accordance with BS EN 1338.

(ii) Clay Pavers

Clay pavers shall comply with the requirements given in BS EN 1344 and shall have the following performance requirements.

- a) Freeze / thaw resistance – all blocks shall be of classification FP100
- b) Transverse breaking load – all blocks shall be of classification T4
- c) Abrasion resistance – all blocks shall be classification A3
- d) Slip / Skid resistance – blocks for predominately pedestrian use shall be of class U1. Blocks for vehicular areas shall be class U3

Note – Prior to the use of the proposed pavers the Developer is required to supply to the Engineer a certificate of conformity showing compliance to the above minimum requirements. In case of dispute then Audit / Compliance testing shall be in accordance with BS EN 1344.

(iii) Paver / Block thickness

The minimum paver / block thickness shall be as given in table 10.8.1

TABLE 10.8.1

AREA OF USE	CONCRETE	CLAY
Footway/pedestrian area	65mm	65mm
Any carriageway use	80mm	65mm

10.8.2 Construction of conventional pavements

The construction of the pavement shall be in accordance with **BS7533 : Part 3 : Code of Practice for the laying of precast concrete paving blocks and clay paviours for flexible pavements** with additions and exceptions as given below;

- (i) The sub-grade shall be prepared and protected in accordance with the requirements given in Section 10, clause 10.2.6.
- (ii) Capping layer and sub-base materials shall be in accordance with Section 10, clauses 10.3.2 and 10.3.3 respectively.
- (iii) The road base material shall be a bituminous material complying with the requirements of BS4987. It shall be either 0/32mm or 0/20mm heavy duty macadam related to layer thickness unless otherwise agreed by the Engineer.
- (iv) Laying course (bedding sand)
The laying course material shall be sand complying with the requirements given in BS7533 : Part 3 : Clause 5.3. Crushed rock fines and recycled aggregates are not permitted.

Note – For the full specification of the laying course material reference should be made to Annex D Clause D.1.1 of BS 7533 : Part 3.

10.8.3 Edge Restraints

Edge restraint shall be provided along the perimeter of all paving and shall comply with requirements given in BS7533 : Part 3 : Clause 5.2. Where intermediate restraint and / or temporary restraint is required then they shall also comply with BS7533 : Part 3 : Clause 5.2.

10.8.4 Installation of Surface Course (Laying pavers and blocks)

The laying of the pavers or blocks shall follow the guidance given in BS 7533: Part 3: Clause 5.4 with the following exceptions.

- (i) The laying pattern shall be chosen to suit the use to which the paving will be subjected as given below:
 - a) 45 or 90° herringbone pattern for vehicular use.
 - b) any acceptable pattern as shown by Annex E of BS 7533 : Part 3 for pedestrian only use.
- (ii) In each row all full units shall be laid first.
- (iii) Closure pieces shall not be less than $\frac{1}{3}$ of a full block and shall be cut by mechanical means and are to be placed with a 3mm joint to edge restraint.

- (iv) Infilling to boundaries and obstructions shall be completed as the laying proceeds and prior to compaction.
- (v) Laying around obstructions, e.g. manholes and gullies shall be in accordance with BS 7533 : Part 3 : clause 5.4.3.2. Where ironwork or other features intrude into the pavement they shall be chosen and installed to ensure the minimum amount of cutting.
Where paving units do not fit neatly around an intrusion / obstruction a concrete surround is to be provided. The concrete is to be either PAV1 or a C35 air entrained mix conforming to BS EN 206-1. For work around intrusions / obstructions then the Developer's attention is drawn to the detail given in BS 7533: Part 3, fig. C.2 which the Engineer requires to be followed.
- (vi) Where concrete is used to in-fill then an acceptable colour match with the surrounding paved area is to be obtained. Fine aggregate, pigment and mixes shall be carefully selected to obtain the required colour match. The colour match shall be tested by trial mixes before use on site. The acceptable mix and mix proportions shall be recorded and submitted to the Engineer for future reference.
- (vii) Uncompacted paved areas shall be protected at all times to prevent disturbance and / or vehicle use.

10.8.5 Compaction of paving units into the laying course

Compaction shall take place as soon as practically possible on completion of the installation of the paving units using an approved vibrating plate compactor. The installation shall be compacted by not less than three passes of the compaction equipment. Compaction shall achieve the specified line and level.

All paving units within 1m of the laying face must be fully compacted prior to the completion of the day's work.

Paving units that are damaged during compaction shall be immediately removed and replaced. Compaction shall continue until full compaction has been achieved and there is no lipping between adjoining units.

The vibrating plate compactor shall be a high frequency, low amplitude mechanical rubber soled flat plate with an area of not less than 0.25m² transmitting a force of 75 to 100kN/m² of plate area when operating at a frequency of 75Hz to 100Hz.

Joint filling after compaction.

It is essential for the paving to function correctly and to prevent premature failure that the joints be filled immediately after compaction. The jointing material shall be dried free flowing silica aggregate (sand) complying with the requirements given in BS 7533 Annex D, clause D.1.2.

The jointing material, which must not stain the surface of the pavement, shall be lightly brushed over the pavers to fill the joints. The surface shall then be subjected to final compaction to ensure complete filling of the joints. This process is to be repeated until the joints are filled. All surplus jointing material shall then be removed from the surface before trafficking. Where after trafficking the pavement shows evidence of the joints are not filled then the above process shall be repeated.

10.8.6 **Surface Regularity**

Surface regularity shall comply with the requirements given in BS 7533 : Part 3 Annex B, clause B.2. with the following additions:

- (i) The maximum permissible deviation from design level overall for the finished pavement is to be within the limits of +/- 6mm.
- (ii) Adjacent to gullies, surface drainage, channels and outlets the maximum deviation shall be +6mm to 0mm.

Note – the permissible deviations for the upper level of drainage inlets and channels shall be +/- 0mm to ensure positive drainage.

Should there be settlement of any section of the pavement the Developer shall investigate and determine the cause of the settlement and shall propose to the Engineer remedial action to rectify the problem and prevent re-occurrence.

10.8.7 **Sealing of the pavement**

All block paved areas shall be sealed. The sealant shall be approved / recommended by the block manufacturer and details submitted to the Engineer prior to sealing work commencing. The Engineer may require a trial to ensure no staining of the blocks occurs and that the sealant adequately stabilises the jointing material.

Note – vacuum sweepers should not be used on the surface for at least three months after laying in order to reduce the risk of jointing material being lost.

10.8.8 **Construction in adverse weather conditions.**

In adverse weather conditions, units shall not be laid where the moisture content of the laying course material is outside the limits given in BS 7533 : Part 3 : clause 5.3.2.1. The filling of joints is not possible in wet and / or damp conditions.

10.8.9 **Recessed Covers**

Where a manhole/inspection cover is located within a block paved area a galvanised steel recessed cover and complying with the appropriate British Standard should be used. Infilling with blocks should be in a such manner as to match the surrounding pattern.

CONTENTS

<i>CLAUSE</i>	<i>TITLE</i>	<i>PAGE</i>
10.9.1	<u>GENERAL</u>	173
10.9.2	<u>FORMATION – INSPECTION AND APPROVAL</u>	173
10.9.3	<u>SUB-BASE MATERIALS</u>	173
10.9.4	<u>FLEXIBLE (BITUMINOUS) CONSTRUCTION</u>	174
10.9.5	<u>ADHESION BETWEEN LAYERS</u>	175
10.9.6	<u>FOOTPATH VEHICULAR CROSSING</u>	175
10.9.7	<u>SURFACE LEVEL TOLERANCES</u>	175
10.9.8	<u>STORAGE OF BITUMINOUS MATERIALS</u>	175
10.9.9	<u>LAYING OF BITUMINOUS MATERIALS</u>	175
10.9.10	<u>SURFACE REGULARITY</u>	176
10.9.11	<u>MODULAR CONSTRUCTION</u>	176
10.9.12	<u>ADJUSTMENT OF UTILITY COVERS</u>	176
10.9.13	<u>TYING INTO EXISTING WORK</u>	177

10.9 FOOTPATHS, FOOTWAYS AND CYCLETRACKS

10.9.1 General

The construction of footpaths, footways and cycleways shall be in general accordance with the requirements of Section 10.7 or unless amended by the following clauses.

The Developer must ensure that all relevant footpaths/footways are constructed to binder course level (as a minimum) prior to occupation of dwellings.

10.9.2 Formation – Inspection and Approval

The formation shall be prepared to give a sound base on which to lay all of the subsequent layers.

Trenches and other excavated areas below formation level are to be reinstated as follows:-

- (a) using sub-base materials placed in layers not exceeding 150mm thick and compacted to refusal.
- (b) using acceptable excavated materials.

Where the Developer proposes to use acceptable excavated materials as backfill to excavations, then notification must be given to the Engineer to enable inspections to be carried out as the backfilling operations progress.

Backfilling operations using acceptable excavated materials must be carried out in accordance with NRSWA.

Where excavated materials are to be used, then operatives need to be trained and certificated in the identification of backfill materials, field identification tests for suitability of backfill materials and compaction of backfill materials in accordance with the NRSWA.

If in the opinion, of the Engineer the operatives cannot fulfil the requirements of the NRSWA – the use of excavated materials will not be permitted.

10.9.3 Sub-Base Materials

All footpath, footway and cycletracks shall have a granular sub-base complying with the requirements of 10.3.3. The sub-base shall be of a nominal compacted thickness of 150mm. The construction detail is given in Sketches 9.3.1 and 10.4.1 for flexible (bituminous) and modular constructions.

Note The detail given in Sketch 10.4.1 is required to prevent shrinkage of the underlying formation material (usually clay of medium or high shrinkage) from resulting in surface cracking particularly with bituminous construction.

Where cracking of the bituminous surfacing occurs then the Engineer will require remedial works to be carried out. An investigation of the cracked areas may also be required to ensure that the detail given in Sketch 10.4.1 has been followed.

10.9.4 Flexible (Bituminous) Construction

(i) Binder Course

The binder course material shall be 0/20mm nominal size dense complying with the requirements of BS4987: Part 1: Clause 6.5. For hand laying operations then the binder viscosity shall be selected from those given in clause 10.7.4.

The binder course shall be laid to a nominal layer thickness of 50mm, shall be fully compacted and free from areas of segregation, crackling and roller marks. Compaction shall be achieved using a static 2.5t dead weight roller applying a minimum of 4 passes.

(ii) Surface Course (Footpath/Footway)

The surface course material shall be 0/6mm nominal size dense complying with the requirements of BS4987: Part 1 clause 7.6. For hand laying operations the binder viscosity shall be selected from those given in Clause 10.7.4.

The surface course shall be laid to give a nominal layer of thickness of 20mm shall be fully compacted and shall be free from areas of segregation, cracking and roller marks. The finished surface shall be laid flush with the kerb.

Compaction shall be achieved using a static 2.5t dead-weight roller applying a minimum of 4 passes.

(iii) Surface Course (Cycletrack)

The surface course shall be of a 0/6mm nominal size material to give a red colour acceptable to the Engineer in accordance with clause 10.7.7.

It shall be laid to give a nominal thickness of 20mm be fully compacted and be free from areas of segregation, cracking and roller marks. The finish surface shall be laid flush with the kerb.

Compaction shall be achieved using a static 2.5t dead weight roller applying a minimum of 4 passes.

Note: It is recommended that those involved in the laying of red pigmented bituminous materials seek advice on acceptable laying practises from the supplier of such material before work commences on site.

10.9.5 Adhesion Between Layers

Where the binder course layer is to remain uncovered for more than 3 days after laying then it shall be sealed by the application of sealing grit complying to the requirements of BS4987 – Clause 7.9. The rate of spread of the sealing grit shall be such as to prevent the underlying binder course becoming contaminated with clay dirt etc. Failure to prevent contamination of the binder course may result in rejection of that layer.

Prior to the laying of the surface course, the footpath binder course shall be cleaned and have a tack coat applied to the satisfaction of the Engineer. The tack coat specification and application shall be as given as Clause 10.7.5.

10.9.6 Footpath Vehicular Crossing

(i) Residential

At each vehicular crossing the sub-base shall be thickened to 225mm and the binder course to 60mm, making the overall construction depth 305mm. The construction details are given in sketch 10.9.1.

(ii) Industrial

The footpath or vehicle crossing shall be constructed to give a finished construction as given in Clause 6.2.8 and Sketch No. 6.2.2.

Note: The mesh reinforcement shown in Sketch No. 6.2.2 may be replaced with fibre reinforcement. Where fibre reinforcement systems are to be used, then the Developer must provide the Engineer with all the relevant information before the works commence. This information must include – fibre type, point of introduction into the concrete, dispersion throughout the concrete.

10.9.7 Surface Level Tolerances

The permitted deviation of the surface level of any footpath, footway or cycletrack layer at any point from the true surface level shall not exceed the following values:-

- (i) formation to receive sub-base +0mm/-30mm
- (ii) sub base to receive binder course +0mm/-15mm
- (iii) binder course to receive surface course +5mm/-5mm
- (iv) surface course +5mm/-0mm

10.9.8 Storage of Bituminous Materials

When stored on site, the material shall be retained in such a manner, as to ensure no deterioration of adjacent or underlying surfaces and that the material retains its workability.

10.9.9 Laying of Bituminous Materials

The conditions given in Clause 10.7.13 shall equally apply to the laying of footpath, footway or cycleway materials.

Laying shall proceed continuously so as to limit the number of joints, particularly in surface course operations, to a minimum. All joints shall be cut back to a sound edge prior to the commencement of the days work. All surface course vertical joints shall be coated with a joint sealant approved by the Engineer.

Compaction shall be applied uniformly across the full width of the footpath, footway or cycletrack and shall be substantially complete while the material is in a workable condition. Particular care will be required around footpath furniture which will necessitate hand compaction using a hand tamper.

Areas of segregation and/or surface cracking due to poor rolling technique will result in the rejection of the surfacing.

10.9.10 Surface Regularity

Where the Engineer considers that the surface regularity of the footpath, footway or cycletrack may affect the end use of these surfaces then the surfacing layers (binder course and surface course) shall be checked using the apparatus and test method given in the Specification for Highway Works – series 7 – Clause 702 (i.e. the rolling straight edge method) with the exception that it shall be carried out at any time specified by the Engineer. The surfacing shall not exhibit any irregularity great than 5mm.

10.9.11 Modular Construction

The use of modular construction systems shall only be permitted with the approval of the Engineer.

(i) Precast Concrete Flags (PCC) Including Tactile Crossing Flags

The flags shall comply with the requirements of BS 7263-1 and shall be of minimum thickness 63mm. Flags shall have the following performance requirements:

- (a) Weathering resistance – all flags shall be of class W2.
- (b) Abrasion resistance – all flags shall be of class A2.
- (c) Slip/skid resistance – flags for predominately pedestrian use shall be of class S2. Flags for vehicular use shall be of class S3.

Note: Testing the above performance requirements shall be in accordance with the relevant annex of BS 7263-1.

(ii) Laying of Precast Concrete Flags

Precast concrete flags shall be laid in accordance with the requirements given in BS 7533: Part 4 to give a finished construction as detailed in sketch 10.4.1.

(iii) Concrete and Clay Paving Blocks

Concrete paving blocks shall comply with the requirements of BS 6717 and shall have the following performance requirements:

- (a) Weathering resistance – all blocks shall be of class W2.
- (b) Abrasion resistance – all blocks shall be of class A2.
- (c) Slip resistance – blocks for pedestrian use shall be of class S2.

Note: Testing the above performance requirements shall be in accordance with the relevant annex of BS6717.

Clay paving blocks shall comply with the requirements of BS6677: Part 1.

(iv) Laying of Blocks

The blocks shall be laid in accordance with the requirements of Section 8.8.

(v) Sealing

The paved area shall be sealed with a proprietary solution approved by the Engineer, after satisfactory joint standing.

10.9.12 Adjustment of Utility Covers

The Developer shall be responsible for the adjustment to all manhole covers, hydrants, services, boxes, gullies etc to suit the finished footpath, footway or cycletrack level to the satisfaction of the Engineer.

10.9.13 Tying into Existing Work

(i) Bituminous

Where new works abuts existing work, then a butt joint shall be formed. The existing work, where required, shall be cut to form a vertical face which is clean and dust free. This face shall be painted with a bituminous sealant to the satisfaction of the Engineer.

The new work shall be adjusted and/or reshaped as directed by the Engineer to match the existing.

(ii) Modular

Where a modular footpath is required to tie into existing then the new works shall match the existing in both line and level and any existing bonding pattern shall be maintained.

The Engineer may require the removal and replacement of existing modules to permit an acceptable tie in point..

(iii) Concrete

Where a new concrete footpath is required to tie into an existing work then an expansion joint without a load transfer system i.e. dowel shall be constructed as shown in sketch 10.6.2 Levels and falls shall match existing

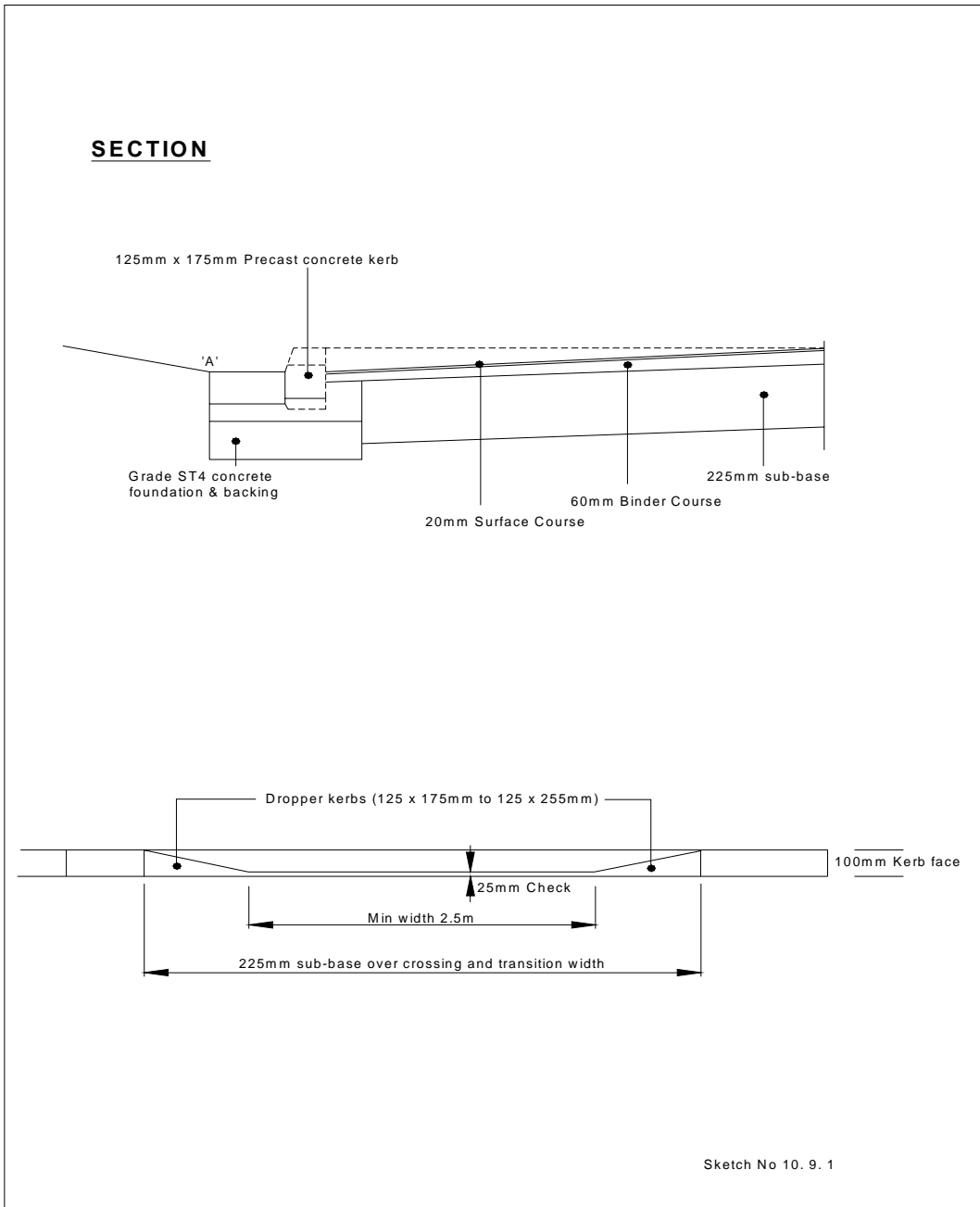

TYPICAL VEHICULAR FOOTWAY CROSSING DETAIL

Sketch No. 10.9.1

CONTENTS

<i>CLAUSE</i>	<i>TITLE</i>	<i>PAGE</i>
10.10.1	<u>GENERAL</u>	180
10.10.2	<u>EXCAVATION</u>	180
10.10.3	<u>BACKFILL MATERIALS</u>	180
10.10.4	<u>SUB-BASE</u>	181
10.10.5	<u>BITUMINOUS BASE (ROAD BASE) AND BINDER COURSE</u>	181
10.10.6	<u>BITUMINOUS SURFACE COURSE</u>	181
10.10.7	<u>MODULAR</u>	182

10.10 REINSTATEMENT

10.10.1 General

The Developer is responsible for all reinstatements until adoption.

10.10.2 Excavation

All excavations shall be carried out in such a manner to avoid damage to the surrounding construction. Excavations shall avoid damage to tree roots.

Trench walls shall be even and vertical with no undercutting of the surrounding construction. Where any undercutting does occur then the void shall be filled as soon as practicable to the satisfaction of the Engineer.

The sides of the excavation shall be supported in accordance with the mandatory requirements of Health and Safety.

Supports shall be withdrawn in co-ordination with backfilling and compaction operations and all voids carefully filled and compacted.

Excavations shall as far as possible be protected from the ingress of water. Excess water in trenches shall be pumped to an approved disposal point.

Bituminous surfacing – each layer shall be "stepped" as shown in Sketch 10.10.1.

Concrete surfacing – shall be cut to the full depth of the concrete.

Modular construction – existing units shall be lifted and stored for reuse. Edge restraint must be provided to all unaffected areas.

10.10.3 Backfill Materials

(i) Carriageways

Backfill materials shall be approved capping or sub-base materials as specified in Section 8.3 and shall be placed in layers not exceeding 200mm or 150mm thick respectively and compacted to refusal.

Where capping is used for backfilling the operation must stop at the base of the existing sub-base. Where sub-base is used for backfilling the operation may continue up to and including the sub-base level.

With the approval of the Engineer foamed concrete, complying with the requirements of the Specification for the Reinstatement of Openings in Highways, may be used up to and including the sub-base layer.

(ii) Footways, Footpaths and Cycletracks

The backfill materials and operation shall comply with the requirements given in Section 10.9.

Note A guide to compaction requirements is given in Appendix A8 of the Specification for the Reinstatement of Openings in Highways.

10.10.4 **Sub-Base**

Where a granular sub-base is used it shall comply with the requirements given in Clause 8.3.3 and shall be compacted using compaction plant approved by the Engineer and shall be compacted to refusal.

10.10.5 **Bituminous Base (Road Base) and Binder Course**

Where reasonably possible bituminous materials used in reinstatements shall be machine laid. Hand laying will only be permitted with the prior approval of the Engineer. Bituminous materials shall comply with the requirements of Section 10.7.

10.10.6 **Bituminous Surface Course**

(i) General

Where reasonably possible surface course reinstatements will be machine laid. Hand laying will only be permitted with the prior approval of the Engineer.

Where it is necessary to carry out reinstatement to material with a red pigmented binder then the Developer shall ensure that the reinstatement matches the existing for colour, texture and surface finish.

Note Reference should be made to the original supplier of the "red" material as the best means of obtaining the match as required above.

(ii) Location of Trench Related to Reinstatement Required

Where a trench runs longitudinally in the carriageway then its location within the carriageway will dictate the reinstatement requirements as follows:-

- (a) Within a half carriageway width – the surface course over the half carriageway must be removed and replaced.
- (b) Along to carriageway centre line – the full carriageway width must be removed and replaced.
- (c) In a footpath, footway or cycletrack – the full width must be removed and replaced.

Note - For footpath, footway or cycletrack surface course reinstatement of this nature, alternatives to full removal may be submitted to the Engineer for consideration.

10.10.7 **Modular**

Where the reinstatement of modular surfacing is necessary then it shall be carried out in accordance with the requirements of BS 7533 : Part 11.

(i) General

It is permitted to reuse modular units that have been removed, cleaned, and then stored during the reinstatement operations. Those modular units, which in the opinion of the Engineer, are unfit to be reused shall be discarded and replaced by units which match the original works in all respects.

(ii) Extent of Reinstatement

Remove an additional 1m of units from around the reinstated area including any units which have been disturbed during the excavation, backfilling and reinstatement operations. The reinstatement shall be carried out in accordance with the requirements of Sections 10.8 and 10.9.

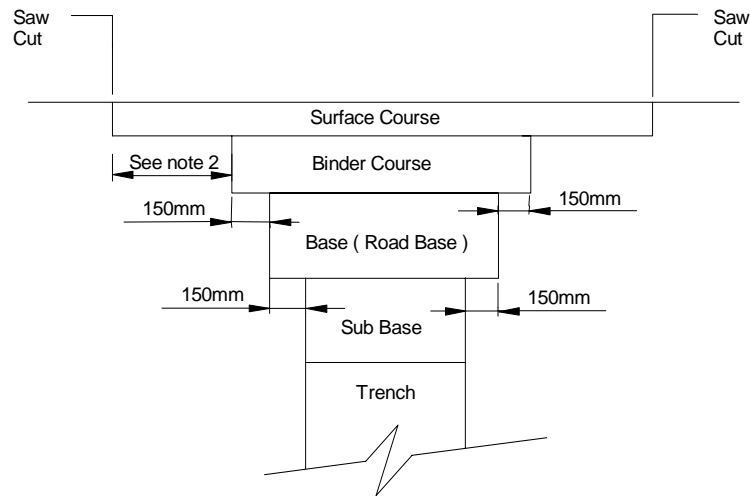

CARRIAGEWAY

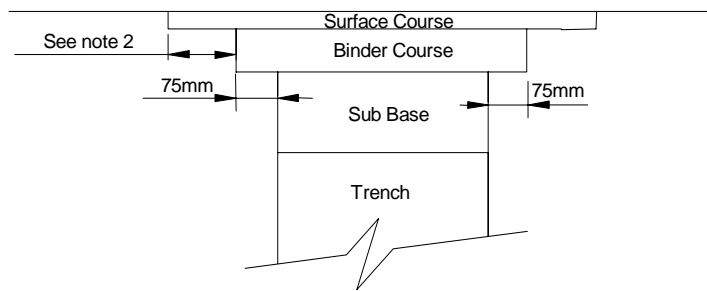

FOOTWAY / CYCLETRACK

NOTES

1. The depth and type of reinstatement materials are specified in Section 8.10
2. Where a trench runs longitudinally in the carriageway, footway or cycletrack then the width of surface course reinstatement shall be as specified in Clause 10.10.6(ii).

Where a trench runs across the carriageway the step width shall be 150mm minimum.

Where a trench runs across the footway or cycletrack the step width shall be 75mm minimum.

10.11 ROAD MARKING

The material shall be hot applied thermoplastic road marking material complying with the requirements of BS EN 1871.

White Road Marking

White road marking shall have the following performance requirements as given by BS EN 1436:

- (a) Luminance co-efficient – Class B2 – 0.3.
- (b) Skid resistance – Class S1 – 45.
- (c) Retro reflectivity (dry) – Class R2 – 100.

Enhanced White Road Marking

Where additional safety requirements are required then the road marking in those areas shall have the following performance requirements:

- (a) Skid resistance – Class S3 – 55.
- (b) Retro reflectivity (dry) – Class R4 – 200.

Note The above values must be maintained for a minimum period of 2 years from the time of adoption.

The Developer shall submit to the Engineer test results that road marking at the time of adoption meets the above performance requirements. Where these test results show that the road marking fails to comply with the performance requirements then they shall be redone in accordance with the Engineer's instruction.

Product certification in accordance with BS EN 1824 Road Marking Materials – Road Trials for Road Marking Material shall be made available for the Engineer stating the performance classes achieved by the product proposed for use.

Application shall be in accordance with the document Application of Marking Materials to Roads and Airfields.

The marking shall be white continuous or intermittent lines, words, figures or symbols. Unless directed by the Engineer all markings shall conform to the Traffic Signs Regulations and General Directions and any subsequent Amendments.

CONTENTS

<i>CLAUSE</i>	<i>TITLE</i>	<i>PAGE</i>
11.1	<u>GENERAL</u>	186
11.2	<u>REGULATIONS AND BRITISH STANDARDS</u>	186
11.3	<u>DESIGN REQUIREMENTS</u>	187
11.4	<u>TYPE OF COLUMNS</u>	188
11.5	<u>COLUMN PROTECTION/IDENTIFICATION</u>	189
11.6	<u>ERECTION OF COLUMNS, BRACKET ARMS AND LANTERNS</u>	190
11.7	<u>INTERNAL WIRING OF COLUMNS</u>	191
11.8	<u>TYPE OF LANTERNS</u>	191
11.9	<u>PHOTO ELECTRIC CONTROL UNIT (PECU)</u>	191
11.10	<u>FUSED CUT-OUTS</u>	192
11.11	<u>UNDERGROUND CABLES</u>	192
11.12	<u>UNDERGROUND CABLE INSTALLATION</u>	192
11.13	<u>ELECTRICITY SUPPLY</u>	193
11.14	<u>COMPLETION OF WORKS</u>	193
11.15	<u>TEST CERTIFICATE</u>	193
11.16	<u>UNDERGROUND CABLE IDENTIFICATION</u>	193
11.17	<u>SKETCHES</u>	193
11.18	<u>STREET FURNITURE - SIGNAGE</u>	193
11.19	<u>DISCONNECTION OR TRANSFER OF STREET FURNITURE</u>	194

11.0 STREET LIGHTING**11.1 GENERAL**

All developments must be provided with an approved form of street lighting prior to being considered eligible for adoption. It should be noted that the Highway Authority will not be responsible for any street lighting erected in non-adoptable situations. Proposals for street lighting must be included with the drawings and specifications to be incorporated in the Section 38 Agreement. The provision of street lighting will be the responsibility of the Developer and all proposals must have the approval of the Engineer prior to works commencing.

The Developer must ensure that all relevant street lighting is operational before occupation of dwellings.

11.2 REGULATIONS AND BRITISH STANDARDS

Street lighting designs must comply with the latest editions of the following:-

BS5489

BS5489-1 : 2003 Code of practice for the design of road lighting-
Part 1: Lighting of roads and public amenity areas.

BS5489-2 : 2003 Code of practice for the design of road lighting-
Part 2: Lighting of tunnels and underpasses.

BS EN 13201 Road Lighting.

BS EN 13201-2 : 2003 Part 2 : Performance requirements.

BS EN 13201-3 : 2003 Part 3 : Calculation of performance.

BS EN 13201-4 : 2003 Part 4 : Methods of measuring performance.

All materials must comply with the relevant British Standards including the following:-

BS5649/EN40 Lighting columns to be manufactured under ISO 9001/9002
Quality Assurance Scheme.

BS4533: Luminaires.

BS5972: Photo electric control units.

BS4782: Ballasts.

BS4017: Capacitors.

BS.....: Electronic control gear

IEC662 High pressure sodium lamps.
White high pressure sodium lamps
Low pressure sodium lamps
Ceramic discharge metal halide lamps
Tubular fluorescent lamps.
Compact fluorescent lamps.

The Highway Authority will consider any other light source that may become Available subject to the approval of the Engineer. Consideration will be given to Best Value when selecting light sources and also by not compromising the quality of the lighting installation. Lanterns shall incorporate electronic control gear obtained from an approved manufacturer.

Street lighting and associated electrical installations must comply with the following:-

- (i) The current edition of the IEE Regulations (BS7671) with particular reference to section 611 (Highway Power Supplies and Street Furniture).
- (ii) The requirements of the R.E.C. with particular reference to requirements for obtaining a metered supply for loads exceeding 500w originating from a single electrical exit point.
- (iii) G39/1 (Regional Electricity Companies publication) with particular regard to siting of columns in the vicinity of overhead lines.
- (iv) The Electricity at Work Regulations.
- (v) Guidance Note GS6 (HSE) – Avoidance of Danger from Overhead Electricity Lines.
- (vi) Should overhead electricity lines cross the site the Developer must seek approval from the Electricity Generator and/or Supplier as appropriate before erecting any columns in the vicinity of the lines.
- (vii) Where columns are sited in the vicinity of high voltage overhead lines a warning notice “DANGER HIGH VOLTAGE OVERHEAD CABLES” must be fixed to the columns adjacent to the lines as a warning to street lighting operatives carrying out future maintenance requirements. The sign is to be manufactured from 3mm thick approved plastic substrate material and fixed by an approved method.

11.3 DESIGN REQUIREMENTS

- (i) Compliance with this specification will still leave a wide range of choice for the Developer. All products complying with British Standards are not necessarily acceptable and therefore proposals must be submitted at an early stage to the Engineer for approval.
- (ii) The Developer’s lighting design proposals, including illuminance data in the form of grid diagrams together with electrical cable calculations, must be submitted for approval to the Engineer.
- (iii) It is essential to ensure that the type and heights of lighting columns is appropriate for the development proposals. Local distributor roads will require mounting heights of 8m or 10m. Mounting heights on proposed bus routes must be a minimum of 6m. Mounting heights of 6m will also be required on other estate roads, unless otherwise agreed with the Engineer.
- (iv) A column mounting height of 8m is to be used for industrial estate roads unless

- (v) Columns shall be positioned at the back of footways/footpaths, or verges within the adopted highway approximately 1.8m from carriageway edge.
- (vi) Columns must not obstruct footways/footpaths, vehicular accesses or be sited in potentially hazardous positions. They shall be sited in accordance with the recommendations in BS 5489-1 2003 section 5.2 and subject to the conditions of Statutory Undertakers. Particular regard should be given to safety clearances from lighting columns and any overhead electricity line which may cross the development.
- (vii) Where a new road is constructed connecting to an existing highway it may be necessary for the Developer to upgrade the existing lighting or provide additional columns as directed by the Engineer. The lighting layout at the junction must be in accordance with BS 5489-1 2003 Annex J.
- (viii) Where traffic calming humps are installed they should be illuminated in accordance with BS 5489-1 2003 Annex A.5 (as sketch 11.3.1)
- (ix) Due to the range of lamps and lamp sizes acceptable for residential development the Developer is advised to contact the Engineer to agree the type, wattage and colour of the lamp to be used prior to commencing design.
- (x) It should be noted that the Highway Authority will not be responsible for any street lighting erected in non-adoptable situations.
- (xi) Street lighting for residential areas shall be designed in accordance with the following:-
 - (a) Local Distributor Roads / Primary Access Roads / Industrial Estates
BS EN 13201-2 2003 section 4 tables 1a / 1b (ME Class)
 - (b) All other residential roads
BS EN 13201-2 2003 section 6 table 3 (S Class)
- (xii) Where columns are to be looped from an REC supply point within a column the Developer shall provide a fused cut-out as specified in Clause 11.10 incorporating a separate HRC fuse (BS88) to protect the outgoing looped circuit, (see Sketch 11.17.1). This method of connection shall be limited to 6 No. columns and a maximum load of 500w.
- (xiii) A suitably approved Feeder Pillar shall be provided when connecting more than 6 No. columns to an REC supply point. No more than 6 No. columns shall be fed from any individual circuit unless approved by the Engineer. The Feeder Pillar shall incorporate a suitable double pole, lockable switch, HRC Fuseboard, The enclosure is to be protected with a suitably agreed external vandal resistant locking mechanism.

11.4 TYPE OF COLUMNS

- (i) Hot Dipped Galvanised Steel columns shall be utilised for a mounting height of 6m. (or as agreed with the Engineer). The bracket shall be an integral part of the column having the same diameter as the column

shaft. The bracket shall not project more than 450mm with a 5 degree uplift

- (ii) In areas not accessible to maintenance vehicles, a steel hinged raising a lowering column shall be used with post top or side entry lantern suitably adapted to fit directly onto the column shaft. An approved lowering mechanism is to be provided to the engineer prior to adoption of the installation in allowing for future sustainable maintenance.
- (iii) Hot Dipped Galvanised Steel columns shall be utilised for a mounting height of 8m or 10m. and Galvanised Sheet Steel for 12m columns. In addition the columns shall be fitted with a removable 5 degree uplift bracket arm incorporating an anti-rotational device. The bracket arm shall not exceed 1.0mt in length. (unless agreed prior to installation with the Engineer). All rigid columns are to be provided with an agreed tamper resistant locking mechanism.

Lighting columns manufactured from alternative materials including stainless steel, extruded 6000-grade aluminium and advanced polymer composite materials are now becoming available. Each of these materials offers the potential of long service life with minimal maintenance requirements and can be considered, subject to the approval of the Engineer.

Where it is known that lighting columns are to be used to support additional loads such as traffic signs, flower baskets, banners / flags and decorations the column shall be designed to carry the additional load.

11.5 COLUMN PROTECTION/IDENTIFICATION

Street lighting columns shall be hot dipped galvanised to BS 729.

Following erection columns shall be T washed, and have one coat of Mebopro 80, Or similar approved product, and one coat of Ameron Steelbond 2134 applied before handover. The colour to be grey to RAL 18B25.

A 2 pack epoxy resin protective coating, to the approval of the Engineer, shall be painted over the base section of the column for a distance equal to the planting depth plus 150mm.

On completion of painting the column shall be provided with an individual Identification number as follows:-

- (a) Columns are to have numbers painted on one side of the column facing the general direction of oncoming traffic or as otherwise directed by the Engineer.
- (b) The numbers shall be black and painted on a yellow background using appropriate stencils and located at 1.8m above ground level. The height of the numbers shall be 40mm. The size of yellow background shall be adequate to accommodate the numbers.
- (c) The type of paint used shall be submitted to the Engineer for approval purposes.
- (d) The column identification will comprise of up to 8 digits and the actual numbers will be provided by the Engineer.

11.6 ERECTION OF COLUMNS, BRACKET ARMS AND LANTERNS

- (i) The columns/lanterns are to be erected in the locations as shown on the approved drawings.
- (ii) Columns shall be erected with adequate mechanical handling plant. Where cranes are used, it shall be ascertained that these, together with any associated equipment, are suitable for the loads to be lifted.
- (iii) Tower ladders or equivalent mechanical platforms shall be used for any work undertaken at higher levels.
- (iv) Holes shall be excavated by hand or approved mechanical means to the appropriate column planting depth. The width of holes shall be kept to a minimum compatible with the ground conditions and should not exceed the width of the flag paced under the base of the column. The maximum width of the flag shall be approximately twice the width of the column base. The Developer shall take due care to avoid damage to existing sewers, drains and services and ensure there is an appropriate safety clearance from any overhead electricity line in the proximity of the works.
- (iv) Prior to erecting columns:-
 - (a) The excavations shall be examined to ensure that it is firm and clear of obstructions, water, rubble and loose soil.
 - (b) The roots of steel columns shall be examined to ensure that the protective coatings are complete. Any bare or corroded patches shall be cleaned and treated in black bituminous paint.
 - (c) Base flags shall be placed in position.
 - (d) The columns shall be visually examined for defects. Defective columns shall be placed aside for examination and for replacement if required by the Engineer.
- (v) Columns shall be erected in strict compliance with the Code of Practice for the erection of street lighting equipment as published by the Association of Street Lighting Erection Contractors.

TABLE 11.6.1

MOUNTING HEIGHT OF COLUMNS	PLANTING DEPTH
6m	1000mm
8m	1200mm
10m	1500mm

- (vi) Columns shall be correctly aligned in the vertical position.
- (vii) Single arm columns shall be installed with the door openings facing away from oncoming traffic. The doors on columns in the central reservation shall face in the same direction along the centre line of the central reservation.

- (viii) After erection, column excavations shall be backfilled with concrete class ST4. Unless specified otherwise the concrete shall be brought up within 150mm of the ground surface. The pavements/surfaces are then fully reinstated.
- (ix) Bracket arms shall be fixed to the columns at the site of installation. The method of securing the bracket arm must be positive such that the arm cannot rotate once fixed. Any screws, bolts, washers used to locate or secure the bracket arm shall be manufactured from Stainless Steel and protected with grease.
- (x) The bracket arm and lantern shall be in line and at right angles to the kerb when fixed to the column.
- (xi) Lanterns shall be fixed firmly to the bracket arms.
- (xii) The lamps and all parts of the lantern effecting the photometric performance shall be cleaned before the lamp is installed.
- (xiii) The whole of the equipment shall be effectively earthed and all exposed metal parts of columns, lanterns and equipment shall be earthed in accordance with the current Edition of the IEE Regulations (BS7671).

11.7 INTERNAL WIRING OF COLUMNS

- (i) The Developer shall (via the Electricity supplier) fix the fused cut-outs onto the baseboard provided in the control gear compartment. Only brass screws shall be used.
- (ii) Internal wiring from the fused cut-out to the lantern, control gear and photoelectric cell shall be single or multicore copper conductor cables, 600/1000 volt grade PVC insulated and sheathed and shall comply with BS 6004.
- (i) All earth continuity bonding conductors shall be sized in accordance with the requirement of the IEE Regulations.
- (ii) The minimum size of internal wiring shall be 2.5mm².
- (iii) See sketch no. 11.7.1.

11.8 TYPE OF LANTERNS

All lanterns shall be vandal resistant and shall be high pressure sodium lanterns with completely sealed optic or similar to be approved by the Engineer with a minimum IP rating 66 with integral control gear.

The lantern shall be complete with Nema Socket or Miniature Photo Electric Cell.

11.9 PHOTO ELECTRIC CONTROL (PECU)

The PECU shall be a miniature type or suitable to fit a standard NEMA socket.

The unit shall have a minimum guarantee of 6 years and be capable of switching a 10 amp inductive load with a switching ratio of 1 to 0.5 operating within a temperature range of -20 to +70. The switch setting shall be clearly identified at

70 lux and operate between the voltage variations from 200v to 260v AC. The unit shall be hermetically sealed with an IP67 rating utilising a self cleaning configuration contained within an impact resistant translucent housing.

The switching mechanism shall incorporate an Electronic Triggering Circuit utilising a transformer power supply capable of withstanding a 1.5KV flash test providing a voltage regulation of 20% or better combining a relay and triac operation in a parallel mode.

11.10 FUSED CUT OUTS

Where street lighting columns are to be energised via public lighting cables, the fused cut-out shall fully comply with the IEE current edition of the Wiring Regulations and shall provide a Double Pole, Switched, lockable 32A Isolator incorporating a BS 88 HRC fuse category 240AC 16. Class Q1 of the appropriate rating.

The fuse cut out shall be complete with a cast brass earth plate suitable for terminating PVC/SWA/PVC cables.

11.11 UNDERGROUND CABLES

- (i) Underground cables shall be 2 core with copper conductors and shall be either:
 - (a) PVC insulated, PVC sheathed, steel wire armoured, PVC served overall 600/1000V grade and must comply to BS6346.
 - or
 - (b) Cross linked polyethylene steel wire armoured, 600/1000V grade and must comply to BS5467.
- (ii) The cables must be BASEC approved.
- (ii) The minimum size of underground cables shall be 6mm².

11.12 UNDERGROUND CABLE INSTALLATION

- (i) All cables shall be laid in accordance with Section 611 of the current Edition of the IEE Wiring Regulations.
- (ii) Cables shall be installed only in complete lengths between column/column, column/sign and column/feeder pillar. No jointing of part lengths will be allowed.
- (iii)
 - (a) The cables shall be laid in trench to a depth of cover of 450mm below finished ground level.
 - (b) The cables shall be laid on 75mm thickness of sand, with a further 75mm of sand placed over the cable.

- (c) Cable identification tape shall be laid approximately 250mm above the cable.
- (d) Trenches shall be backfilled and compacted with suitable material free from flints, stones or other sharp objects injurious to the cable.
- (e) The finished level shall be the same as that of the surrounding level.

11.13 ELECTRICITY SUPPLY

The Developer must make satisfactory arrangements with the electricity supplier for the electricity supply for the street lighting installation and to ensure that all necessary cross-road ducts are provided before the carriageways are constructed. Should a developer decide to appoint an alternative DNO to the local DNO for the provision of the supply cable network onto a site it would be the responsibility of the appointed DNO to respond to any future network supply faults as no reciprocal agreement between DNO's are currently in place. If this were the case the street lighting would have to be placed on a loop with a direct feed via a feeder pillar to the local DNO's cables. It must be stated at the time of the street lighting submission if an alternative DNO is to be used

11.14 COMPLETION OF WORKS

The lighting works shall be carried out to an approved standard and completed prior to the occupation of properties. The Developer shall be responsible for the protection of units after erection and until such time as the lighting works are taken over. The Highway Authority will accept responsibility for energy charges when installation is satisfactorily complete and following the issue of the part 2 Certificate (Refer to Clause 3.8.2).

11.15 TEST CERTIFICATE

Prior to the issue of the Part 2 Certificate – (refer to Clause 3.8.2) the whole of the street lighting network shall be tested in accordance with the IEE Regulations and recorded on forms ET1 and ET2 respectively (see Appendix 11.1 and 11.2). This information shall be submitted to the Engineer together with the “as fitted” electrical records drawings showing full details of all electrical circuits and cable runs.

11.16 UNDERGROUND CABLE IDENTIFICATION

All cables coming into columns should be identified as shown in Sketch 11.16.1.

11.17 SKETCHES

Public lighting supply details are shown on Sketches 11.17.1 to 11.17.3.

11.18 STREET FURNITURE – SIGNAGE

The specification for street furniture requiring electrical services will comply with the following:

- (i) In allowing for sustainable maintenance, agreement is required from the Engineer as to the manufacturer and unit type proposed for the installation, this could accommodate for either internally or externally illuminated sign light units.

- (ii) Suitably designed for weight and windage, hot dipped galvanised tubular steel.
- (iii) 32a DP combined isolator and fuse unit (cut out) in the base of the signpost as a means of local independent electrical isolation.
- (iii) Miniature photo electric cell (PEC) fitting in accordance with Clause 11.9.
- (iv) All unique external unit referencing will be allocated for identification purposes in accordance with Clause 11.5.
- (v) Class 1 diamond grade legends on either GRP, steel, or aluminium base units.
- (vi) External site protective coating application in accordance with Clause 11.5.
- (vii) The minimum mounting height shall be 2.45 metres to underside of sign plate.
- (ix) Prior to the issue of the Part 2 Certificate (refer to Clause 3.8.2) for each Street Furniture item with an electrical supply the following must be submitted to the Engineer:
 - Data Verification form (DV)
 - Electrical Test Certificate (ET1)
 - Electrical Test Certificate (ET2) where applicable
 - The location of underground cable routes for supply purposes must be submitted as “fitted drawings” in an approved format.

11.19 DISCONNECTION OR TRANSFER OF STREET FURNITURE

The developer is required to contact the relevant authority with regards to the removal or transfer of any street furniture installation.

TEES VALLEY COUNCIL'S TEST & INSPECTION CERTIFICATE – INTERNAL COLUMN/SIGN WIRING

Column/Sign/Bollard Reference No: **ET1**

Column/Sign/Bollard Location:

Unit Type: Height: Bracket:

Wattage of Lamp: Control Gear: Supply of Source:

Type of Fitting: Circuit Protection Fuse BS Type: Rating Amms:

MBC Class: RCD Type: Limiting Impedance (Ohms):

VISUAL INSPECTION	SIZE	Correct	Failure	Reason
Identification of conductors		<input type="checkbox"/>	<input type="checkbox"/>	<input type="checkbox"/>
Size of circuit conductors	<input type="text"/>			
Earth Terminal:		<input type="checkbox"/>	<input type="checkbox"/>	<input type="checkbox"/>
Earthing Conductors:				
(a) Main equipotential bonding conductor:	<input type="text"/>	<input type="checkbox"/>	<input type="checkbox"/>	<input type="checkbox"/>
(b) Armour earthing continuity conductor:	<input type="text"/>	<input type="checkbox"/>	<input type="checkbox"/>	<input type="checkbox"/>
(c) Circuit protective conductor:	<input type="text"/>	<input type="checkbox"/>	<input type="checkbox"/>	<input type="checkbox"/>
Earth cables sleeved:		<input type="checkbox"/>	<input type="checkbox"/>	<input type="checkbox"/>
Insulation of Live Parts (i.e. IP2X)		<input type="checkbox"/>	<input type="checkbox"/>	<input type="checkbox"/>
Fuse Unit of Live Shroud:		<input type="checkbox"/>	<input type="checkbox"/>	<input type="checkbox"/>
Neutral Shroud		<input type="checkbox"/>	<input type="checkbox"/>	<input type="checkbox"/>
Is Capacitor fitted? <input type="checkbox"/>			Is light working? <input type="checkbox"/>	

ELECTRICAL TESTING

Insulation Resistance Phase/Protective (ohms) Neutral Protective (ohms)

Polarity Satisfactory

Nominal Voltage (volts)

Earth Fault Loop Impedance at Fuse Unit (ohms)

Earth Electrode (where applicable) (ohms)

RCD (Where applicable) m sec

Comments/Corrective Action:

Testers Name Test Date

I CERTIFY THAT TO THE BEST OF MY KNOWLEDGE AND BELIEF THE ABOVE INSTALLATION HAS BEEN INSPECTED AND TESTED IN ACCORDANCE WITH THE CURRENT EDITION OF BS 7671 – IEE WIRING REGULATIONS

Signature

APPENDIX 11.2

**TEST AND INSPECTION CERTIFICATE –
LIGHTING CABLE NETWORK (ET2)**

Report Ref No:

Location <input type="text"/>	Ref No: <input type="text"/>
Source (F/pillar/column/E) <input type="text"/>	Circuit: <input type="text"/>
Cable: <input type="text"/>	System and Earthing Type: <input type="text"/>
Circuit protection: Fuse BS No: <input type="text"/>	Rating(A) <input type="text"/>
	Limiting Impedance (OHMS): <input type="text"/>
MBC Class <input type="text"/>	

1. Visual Inspection: Satisfactory? Yes No

2. Earth Electrode Resistance (OHMS)
(where applicable)

3. Insulation Resistance (M OHMS)

R-B	R-Y	Y-B	R-N	Y-N	B-N	R-E	Y-E	B-E	N-E

4. Polarity: Satisfactory? Yes No

5. Earth Fault Loop Impedance (OHMS)
Source:.....Remote End:.....

6. RCCB Operation (where applicable)
Manufacturers Value:.....Test Value:.....

7. Voltage drop (@ full load – V)
Source:.....Remote End Voltage:..... Volt Drop:.....

8. Comments:

I CERTIFY THAT TO THE BEST OF MY KNOWLEDGE AND BELIEF THE ABOVE INSTALLATION HAS BEEN INSPECTED AND TESTED IN ACCORDANCE WITH THE CURRENT EDITION OF THE IEE WIRING REGULATIONS

Print Name:.....Signature.....Date / /

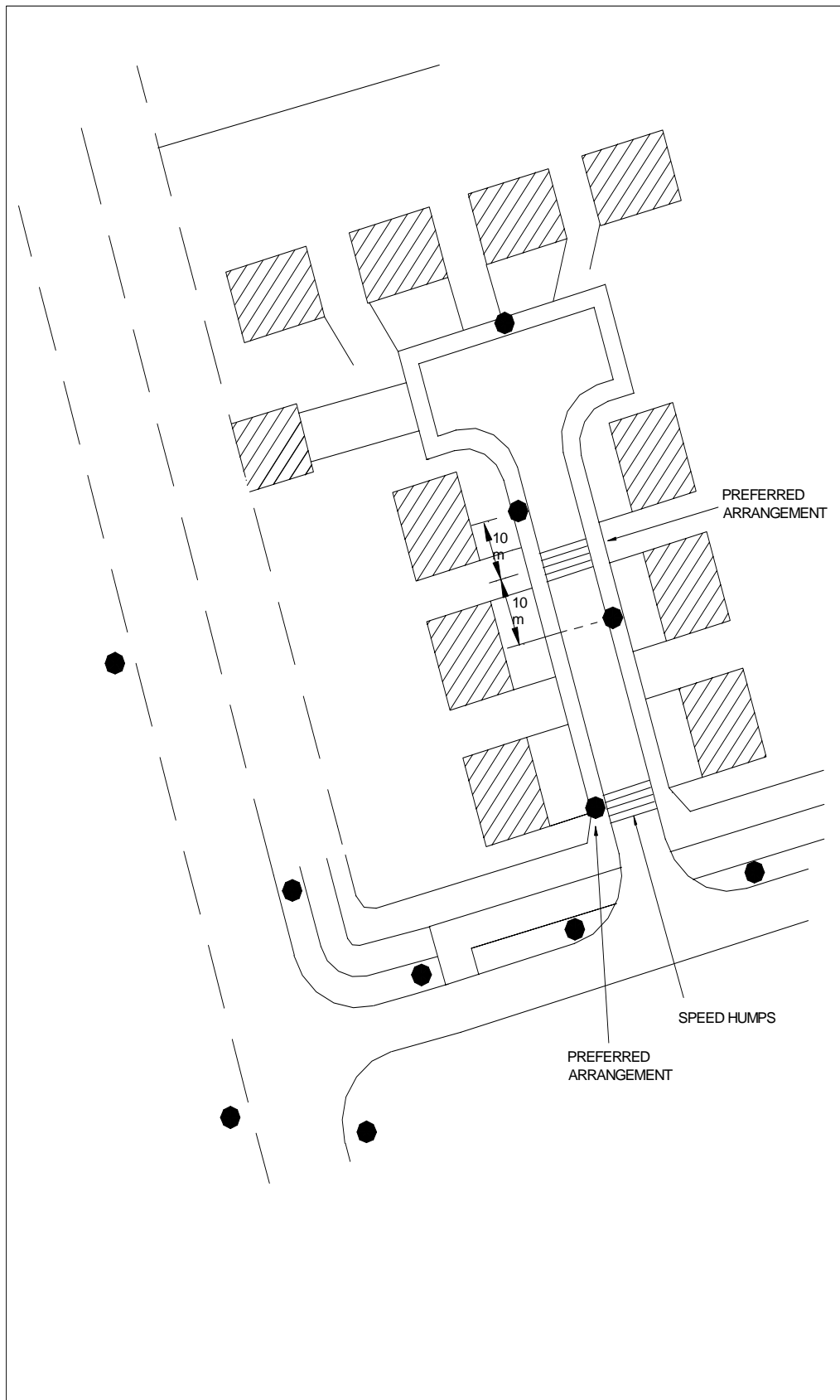

TYPICAL STREET LIGHTING LAYOUT WITH SPEED BUMPS

Sketch No. 11.3.1

REMOTE CONTROL GEAR SHOWN

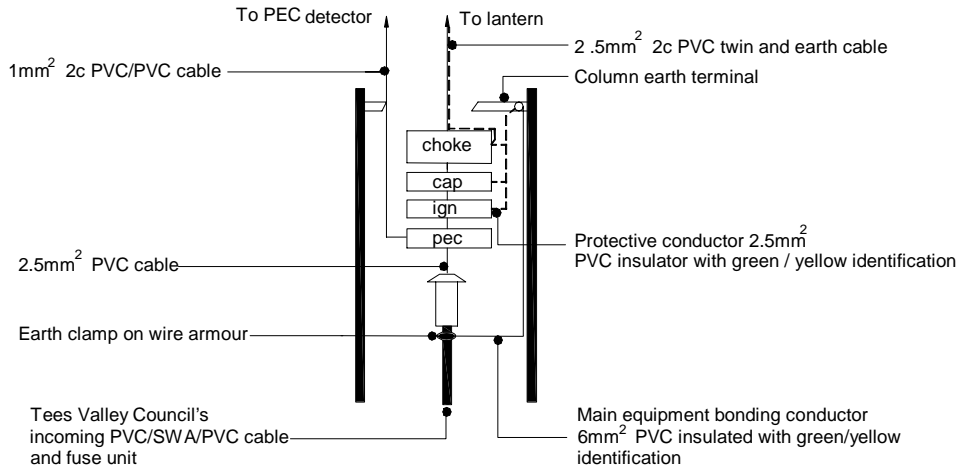

TNS - SYSTEM (EARTH VIA SHEATH OF SUPPLY CABLE)

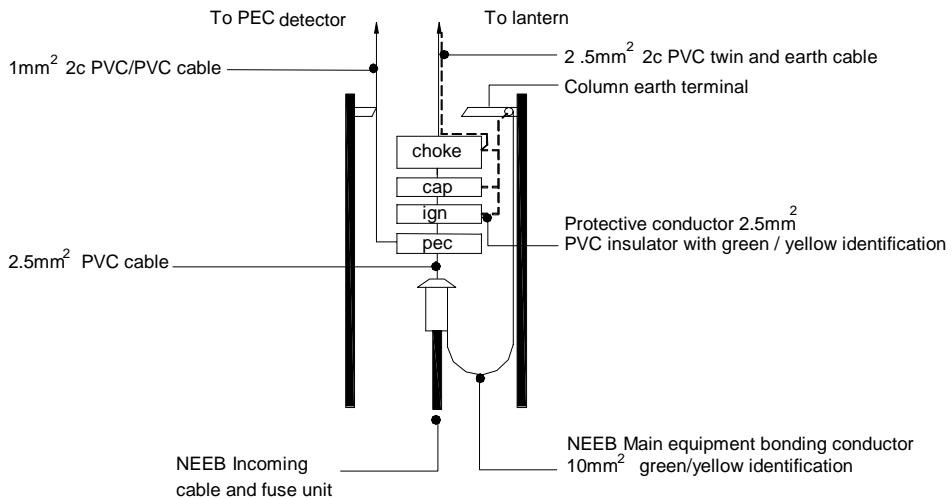

TNS - S SYSTEM (NEUTRAL AND PROTECTIVE CONDUCTOR)

Note:
 All components to be earthed via earthing terminal provided.
 For integral control, gear choke, capacitor, ignitor & photo electric cell installed in lantern.

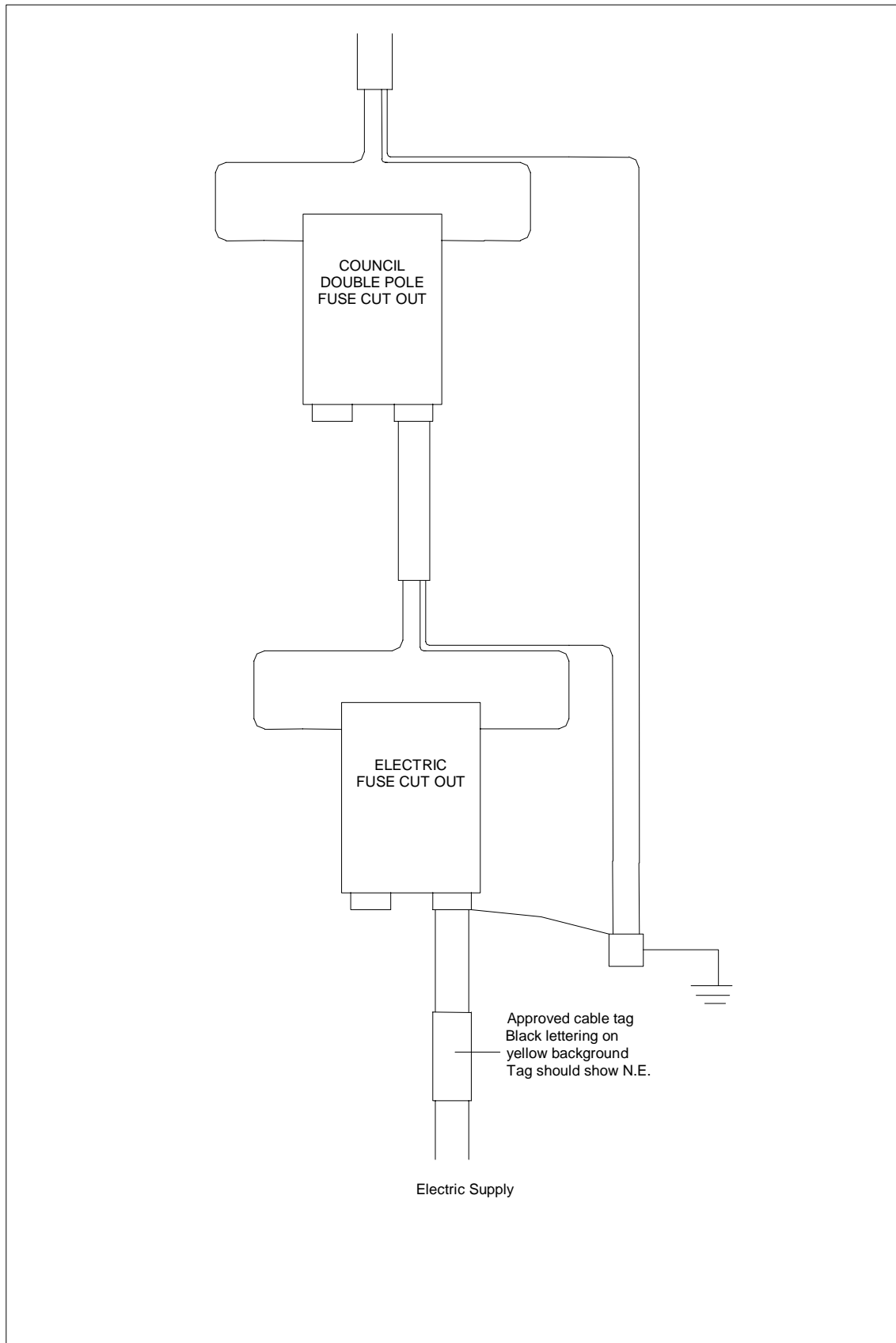

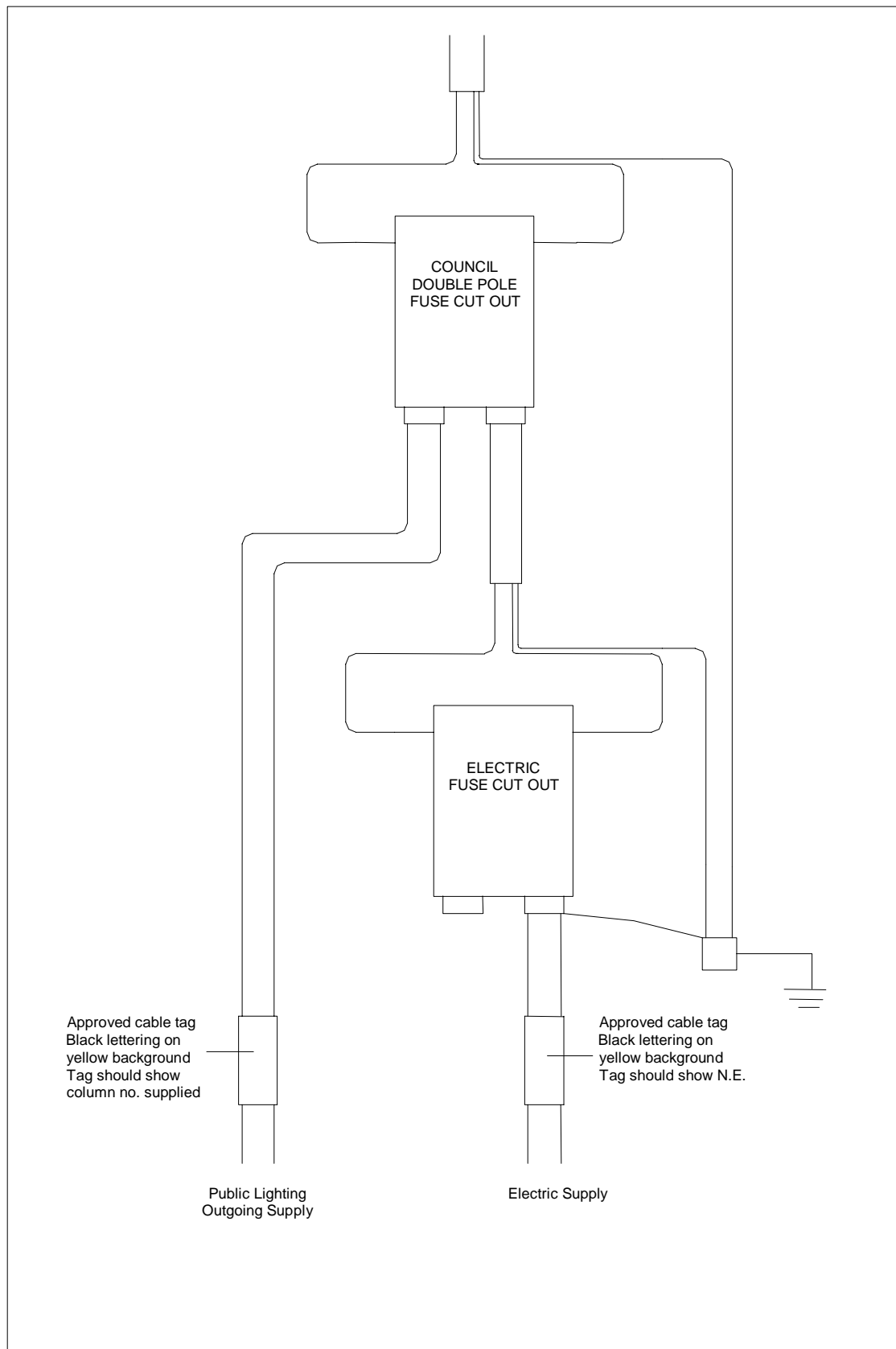

SUPPLY USING ONE LOOP

Sketch No. 11.17.1

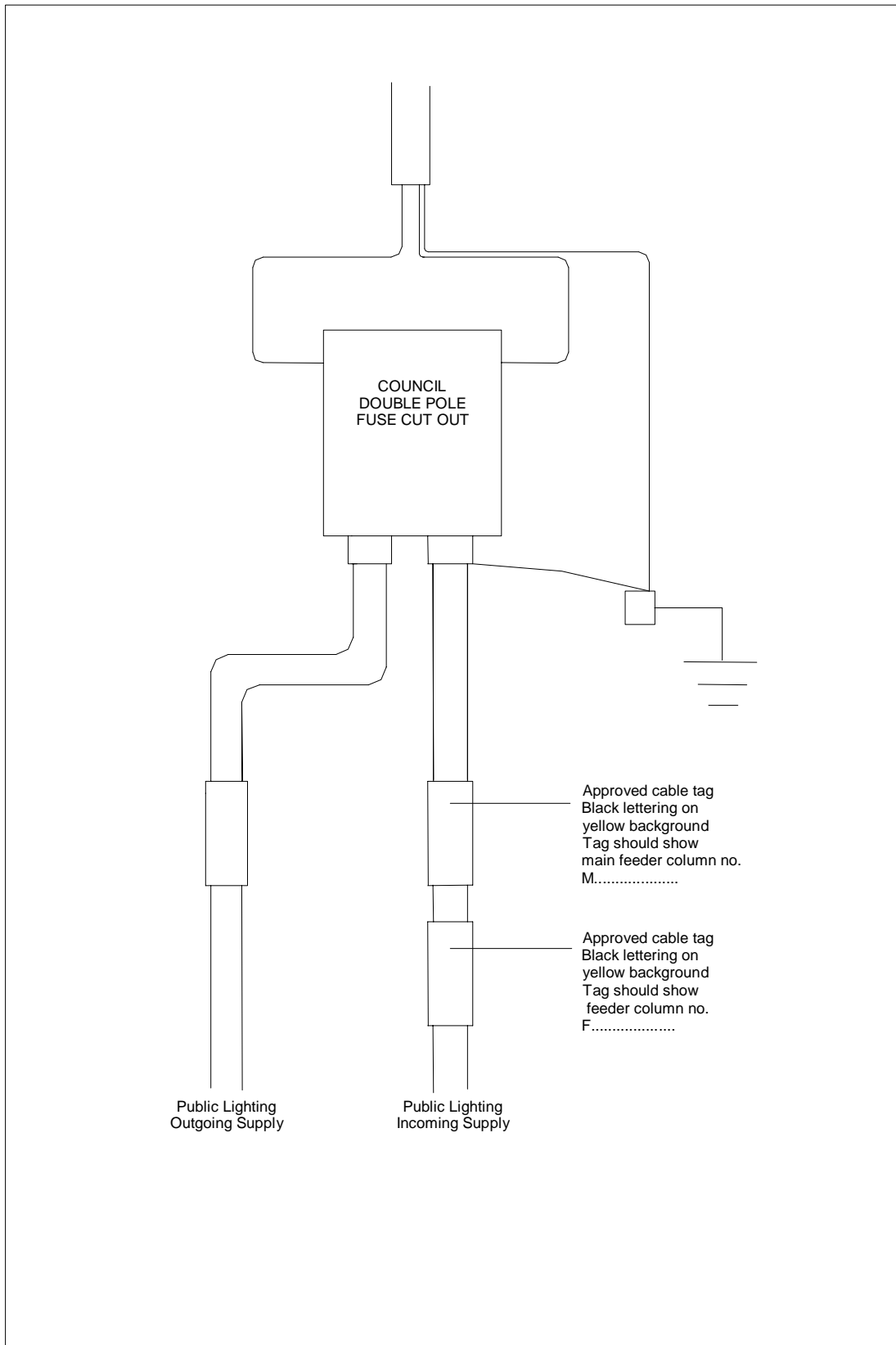

PUBLIC LIGHTING SUPPLY (In and Out)

Sketch 11.17.2

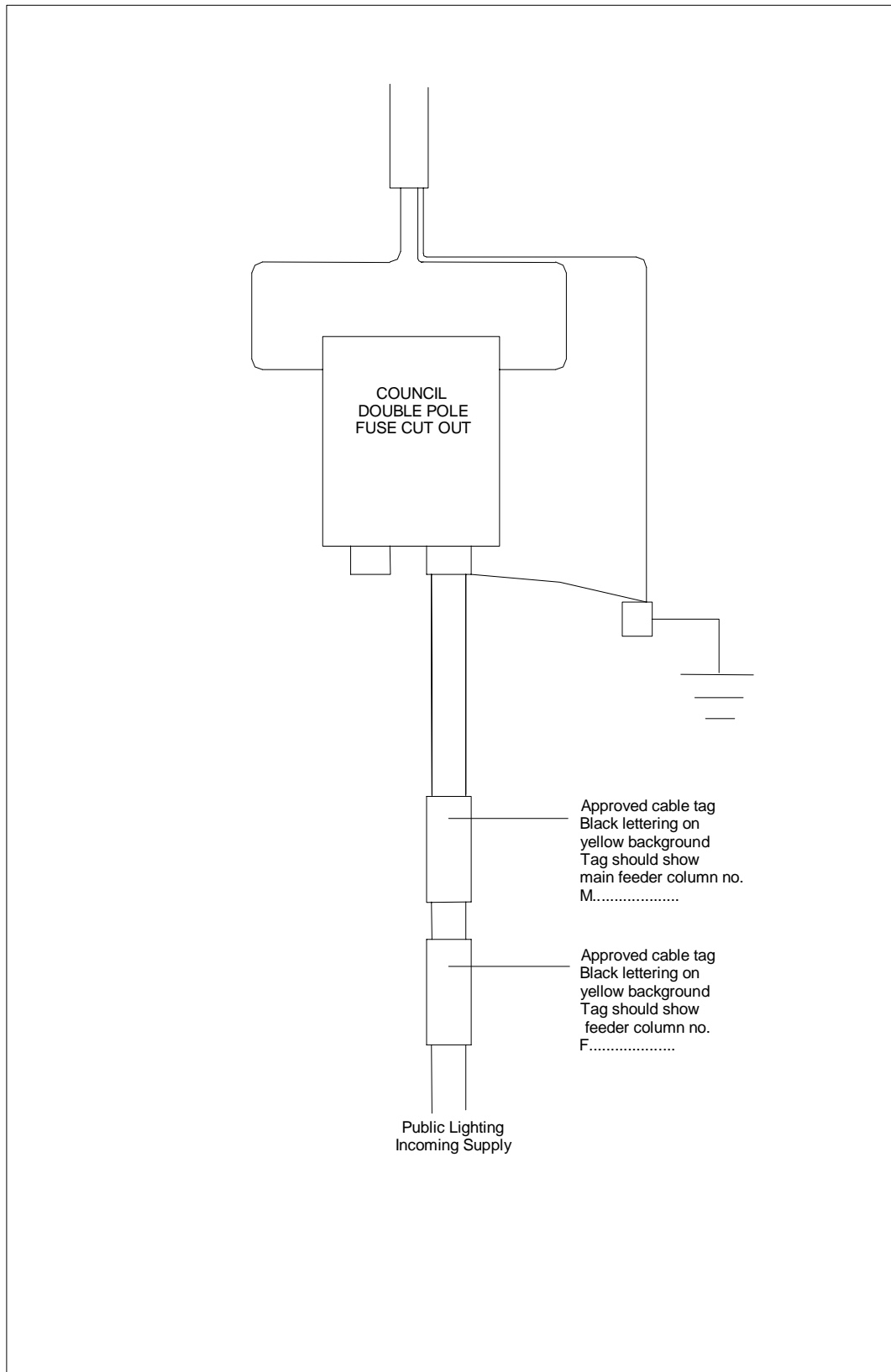

PUBLIC LIGHTING SUPPLY END OF LOOP

Sketch No 11.17.3

CONTENTS

<i>CLAUSE</i>	<i>TITLE</i>	<i>PAGE</i>
12.1	<u>INTRODUCTION</u>	204
12.2	<u>LOCATION OF HIGHWAY DRAINS</u>	204
12.3	<u>PIPES FOR DRAINAGE</u>	204
12.4	<u>TRENCH EXCAVATION</u>	205
12.5	<u>MANHOLES</u>	208
12.6	<u>CARRIAGEWAY GULLY CONNECTIONS</u>	210
12.7	<u>EXISTING FIELD DRAINS</u>	212
12.8	<u>PROTECTION OF EXISTING WATER COURSES</u>	213
12.9	<u>OUTFALL TO WATERCOURSES</u>	213
12.10	<u>CCTV SURVEY</u>	214
12.11	<u>STRUCTURES</u>	214

12.0 HIGHWAY DRAINAGE**12.1 INTRODUCTION**

This section is to be used for the design and construction of highway drainage only.

The Highway Authority is responsible for the adoption of surface water systems serving highway areas only. The highway drainage system will consist of those lengths where no other drainage is being received, other than from adopted areas and where the Water Authority has indicated that it is not prepared to adopt that system.

The design and construction of a drainage system should be fully in accordance with the criteria set out in the Water Authorities Association "Sewers for Adoption – A Design and Construction Guide for Developers" current edition (except as amended by this document).

12.2 LOCATION OF HIGHWAY DRAINS

Highway drains shall be constructed within the limits of the highway.

Where there is a requirement that the drain is located outside the limits of the highway, i.e. outfall to water courses (see also Clause 4.5 and 12.8), a 'Deed of Grant of Easement' will be required. It is the responsibility of the Developer to obtain all such consents.

12.3 PIPES FOR DRAINAGE

12.3.1 Pipes for drainage shall be selected from the alternatives given in Table 12.3.1 and shall comply with the specification requirements applicable to the pipe type selected.

TABLE 12.3.1

MATERIAL TYPE	STANDARD
Vitrified clay	BS 65
Concrete	BS5911:Part 100
Unplasticised polyvinyl-chloride	BS4660 or BS5481
Plastics	BS4962

12.3.2 Minimum Pipe Size

The minimum pipe diameter for carriageway drainage shall be 150mm. For footpath, footway or cycleway the minimum pipe diameter may be 100mm.

All site connections within the limits of the carriageway shall be a minimum of 150mm diameter.

12.4 TRENCH EXCAVATION

- 12.4.1 All trenches shall be excavated in straight lines, to the correct levels and shall have vertical trench walls.

If the pipe formation is damaged, through any cause, and is considered by the Engineer to be unacceptable for the construction of the pipeline then the Developer shall, as directed by the Engineer, remove the damaged formation and backfill with an approved granular material.

12.4.2 Support to Utility's Apparatus

The Developer shall protect and support any utility's apparatus which pass over or under the line of the drain and before the completion of the works restore them to their original condition. All works shall be carried out to the satisfaction of the Engineer and to the requirements of the Statutory Undertakers and the owners of the apparatus.

12.4.3 Tidal, Flowing, Ground Water and Standing Water

The Developer shall take measures and carry out any operations necessary for dealing with tidal, flowing, ground water or standing water within the site.

A method statement detailing the measures and operations shall be submitted to the Engineer.

12.4.4 Bedding and Laying of Pipelines and Backfilling of Trenches

Immediately following the excavation of the trench the pipes shall be laid and jointed on the pipe bed. Pipes shall be laid so that each one is in contact with the bed throughout the length of its barrel. In the case of socketed or sleeve jointed pipes the socket or sleeve shall not bear directly on the bed. See sketch no. 12.4.1.

The pipes shall be laid to the design level and gradients.

Pipe bedding material shall be selected from the appropriate bedding given in Table 12.4.1.

Trenches shall be backfilled as soon as practicable after the drain has been laid. The Developer shall give the Engineer reasonable notice (at least 24 hours) that the pipeline is complete and ready for testing.

Drains shall have watertight joints and shall be tested as described in Clause 12.4.5.

Backfilling operations shall be as follows:-

- (a) Area around and immediately above pipe (0mm to 300mm above crown of pipe)

The material shall be Type A consisting of crushed rock (excluding shale), crushed blast furnace slag from a source approved by the Engineer or crushed concrete complying with the grading requirements of Table 12.4.1.

The material shall be carefully placed and compacted using light compaction techniques in layers not exceeding 150mm, from bedding level to 300mm above the crown of the pipe.

NOTE: There are many methods of achieving light compaction and therefore it is not the intention, nor indeed possible in this document to give all acceptable combinations. The compaction method adopted by the Developer should take into account that light compaction immediately around and above the pipe is essential to prevent damage to the pipe.

- (b) Area outside light compaction (300mm and above from crown of pipe)

In carriageways, the remaining depth of trench up to formation level shall be backfilled with Type B material consisting of crushed rock (excluding shale), crushed blast furnace slag (from a source approved by the Engineer) or crushed concrete.

The backfill shall be placed in layers not exceeding 150mm and compacted by mechanical means.

NOTE: The Engineer may at any time carry out in situ density tests on the compacted backfill to ensure that full compaction has been achieved. This testing shall not include light compaction areas.

If the in situ density test results indicate that compaction is inadequate then the backfill shall be removed to a depth specified by the Engineer, replaced and compacted as detailed above.

In footways, footpaths and cycleways backfilling operations shall comply with the requirements of Clause 10.10.3.

In highway verges trenches may be backfilled with selected excavated materials, subject to the approval of the Engineer.

When trench supports are employed, they shall be withdrawn in a safe manner not more than 600mm in advance of the compacted backfilling operations. Any cavity occurring during the withdrawal of trench supports shall be filled and compacted to the satisfaction of the Engineer.

The Developer will be held responsible for any settlement which occurs after backfilling operations have been completed and any remedial action required by the Engineer until adopted by the Highway Authority.

TABLE 12.4.1

NOMINAL SIZE OF PIPE	MAXIMUM PARTICLE SIZE (mm)	SUITABLE IMPORTED GRANULAR MATERIALS FOR BEDDING
100	10	10mm single size bedding
Over 100 to 150	14	10, 14 single size or 14 to 5mm graded bedding
Over 150 to 300	20	10, 14 or 20mm single size or 14 to 5mm graded or 20 to 5mm graded bedding
Over 600	40	14, 20 or 40mm single size or 14 to 5mm graded or 20 to 5mm graded or 40 to 5mm graded bedding

12.4.5 Testing Gravity Drains

Pipeline lengths shall be tested between manholes and shall comply with the conditions given below. All drains shall be tested with air or water as directed by the Engineer.

(i) Air Test

For the pipeline air test, air shall be pumped into the line by a suitable means until a stable pressure of 100mm head of water has been achieved as indicated in a U-tube connected to the system. The air pressure shall not fall to less than 75mm head of water during a period of 5 minutes without further pumping, after an initial period to allow stabilisation. Drains with traps shall be tested to 50mm head of water and the permissible loss shall be not more than 14mm head of water in 5 minutes after the initial stabilisation period.

(ii) Water Test

For the pipeline water test the pipes shall be filled with water under a head of not less than 1.2m above the crown of the pipe at the high end and not more than 6m above the pipe at the low end. Steeply graded pipelines shall be tested in sections so that the above test conditions are met. Unless otherwise agreed by the Engineer the test shall commence two hours after filling the test section. The loss of water over a period of 30 minutes shall be measured by adding water to the vertical feed pipe at regular 10 minute intervals to restore the original water level. The amounts of water added at each interval shall be recorded. The drain shall be deemed to have passed the test if the water added does not exceed one litre per hour per linear meter of drain per metre of nominal internal diameter.

12.4.6 Private Connections

Private connections, not forming part of the adoptable sewer system within the highway limits, are the responsibility of the Developer and his successors but shall be constructed in accordance with this specification.

12.5 MANHOLES

12.5.1 Construction of Manholes

Manholes shall be constructed in accordance with 'Sewers for Adoption'.

12.5.2 Precast Concrete Manholes

Precast concrete manhole rings shall comply with BS5911:Part 200.

12.5.3 Manhole Covers and Frames

Covers and frames for manholes shall be ductile iron complying with BS EN124 and shall be painted with one coat of bituminous compound, to the approval of the Engineer.

Manholes greater than 1.2m deep shall have a minimum opening of 675mm x 675mm.

For manholes constructed in carriageways heavy duty double triangular covers and frames (BS EN124 Class D400) shall be used. For manholes constructed in footways and verges medium duty covers and frames (BS EN124 Class B125) shall be used.

Where manholes are located in areas of modular paving (block paving) the cover and frame shall be of a type approved by the Engineer with inlaid blocks to match the surrounding paving in block type, colour, texture and pattern.

12.5.4 Bricks

All bricks for engineering works associated with the highway drainage shall be clay Class B Engineering bricks complying with the relevant provisions of BS 3921. The shapes and dimensions of special bricks shall comply with the relevant provisions of BS4729.

12.5.5 Brickwork for Manholes

Brickwork for manholes shall be English bond and shall be laid on a full bed of mortar. Single frogged bricks shall be laid frog up. Immediately after laying and for three days thereafter the brickwork shall be protected against the harmful effects of weather.

12.5.6 Mortar

Cement shall be Portland Cement complying with BS12 or Sulphate Resisting Cement complying with BS4027 where site conditions dictate resistance to sulphate attack is required.

Sands shall comply with BS1199 and BS1200.

Water for mixing shall be potable water from the public water supply, for which the Developer shall obtain the necessary consent of the Water Authority.

Water from any other source is not acceptable.

Mortar for brickwork shall be mixed in the proportions detailed in Table 12.5.1 below to the mortar class required.

TABLE 12.5.1

CLASS	CEMENT : SAND	CEMENT : SAND WITH PLASTICISER	CEMENT : LIME : SAND
2	1:2.5 to 3.5	1:3 to 4	1:0.5 to 4.5

If work is to be carried out in the winter months with the expectation of temperatures below freezing, then the use of an air entertainment plasticiser shall be used. The plasticiser shall be free from calcium chloride and shall comply with the requirements of BS4887.

The lime proportions given in the Table 12.5.1 are for lime putty complying with the requirements of BS890. The addition of any other lime will require the approval of the Engineer.

The mortar shall be mixed thoroughly either by hand or in a mechanical mixer until it's colour, texture and consistency are uniform. The constituent materials shall be accurately gauged.

The mortar shall be mixed in small quantities only as and when required. Mortar which has begun to set or has been mixed for a period in excess of 2 hours shall be discarded.

Ready mixed lime : Sand mortars are ready to use retarded mortar are acceptable providing they comply to the requirements of BS4721 and be of category 1:12 and designation (ii).

12.5.7 **Manhole Foundations – Concrete**

Foundations to manholes to be ST4 concrete.

12.5.8 **Adjustment of Manhole Covers**

All manholes and service boxes shall where necessary be taken up and reset to the proposed finished levels. Where any Statutory or other Authority carry out work themselves, then it shall be the responsibility of the Developer to ensure that this work is completed prior to the laying of surface course material.

Any part of the manhole covers or service boxes against which the bituminous material is to be laid shall be cleaned and painted with hot bitumen or bituminous emulsion to the approval of the Engineer.

12.5.9 **Future Connections**

To avoid future disturbance to the highway an appropriate sized sewer shall be constructed to beyond the limits of the highway to a size and position agreed with the Engineer. This pipeline, if not used immediately, shall be fitted with earthenware stoppers or seals and fixed with a 1 to 10 cement : sand mortar or as approved by the Engineer.

The position of each connection shall be clearly marked on site and it's position recorded on the as-constructed plans.

12.6 **CARRIAGEWAY GULLY CONNECTIONS**

Connections from gullies to highway drains must be made with flexible jointed dense vitrified clay pipes or UPVC pipes. The full length of the pipe shall be totally surrounded with a 150mm thickness of Grade ST4 concrete incorporating flexible joints at no more than 3m centres, see sketch no. 12.4.1.

Backfilling shall be in accordance with Clause 10.10.

12.6.1 **Gully Spacing**

For road gradients from 1.25% (1 in 80) to 0.67% (1 in 150) each gully shall drain an area of carriageway and footpath, including highway verge, not exceeding 200m².

Where gradients are in excess of 1.25% (1 in 80) the area shall not exceed 250m².

The spacing of gullies for footpaths shall be agreed with the Engineer.

12.6.2 Carriageway Gully Pots

Carriageway gully pots shall comply with the requirements of BS5911 : Parts 1-3 and be manufactured from concrete with granite aggregate. They shall be 380mm internal diameter and 780mm internal depth with 150mm diameter single seal trapped outlet and cleaning eye complete with rodding eye and stopper, see sketch 12.6.1.

The gully pots shall be bedded on a foundation of 150mm of Grade ST4 concrete and be surrounded with concrete of the same class for the full depth of the gully.

The surround shall in general be circular and 100mm minimum thickness but that part of the rim or lip of the gully shall be cast rectangular on three sides to support the brickwork under the gully frame and chamfered at 45 degrees into the circular surround.

12.6.3 Carriageway Gully Grates and Frames

Gully grates and frames shall be of ductile iron and comply with the requirements of BS EN124 (BS EN Class C250). They shall be painted with one coat of bituminous compound.

The gully grate and frame is to be fitted with a theft resistance device and shall be set with the hinge facing the direction of traffic flow and at such a level that the grate and frame shall be set on two courses of 230mm brickwork (Class B), all mortar corbeled as shown on sketch 12.6.1; the grating being 12mm below the finished surface level of the channel.

Gullies shall be kept clean and free from debris during the course of the work and shall be sealed with clean water as soon as construction is sufficiently advanced for them to function.

At the end of the maintenance period and immediately before handing over the completed work all gullies shall be thoroughly cleaned out and after inspection by the Engineer resealed with water.

12.6.4 Footpath Gully Connections

Connections from gullies may be made with flexible jointed dense vitrified clay pipes or externally ribbed UPVC pipes (complying with Sewers for Adoption). The full length of the pipe shall be totally surrounded with 100mm thickness of Grade ST4 concrete with flexible joints at no more than 3m centres.

12.6.5 Footpath Gully Pots

Footpath gully pots shall be 300mm diameter in accordance with BS539 : Table 24 and shall be constructed in accordance with Clause 12.6.2.

12.6.6 Footpath Gully Grates and Frames

Footpath gully grates and frames shall be circular and hinges with a locking grid. They shall comply with the general manufacturing requirements of BS EN124 and be a type approved by the Engineer. They shall be manufactured in ductile iron to BS EN124 (BS EN Class B125 – 325) and shall be set on a mortar bed.

12.6.7 Coating of Ironwork

If ironwork shows signs of rust at the end of the maintenance period it shall be wire-brushed and re-coated with a bituminous compound/solution or replaced if considered necessary by the Engineer.

12.7 EXISTING FIELD DRAINS

Where it is necessary for the Developer to cut through existing field drains steps must be taken to carry the sub-soil water to its outfall in as free a manner as before the commencement of the works by reinstating with pipes of the same size and capacity as the original.

When this is not possible the Developer may wish the agreement of the Engineer make a proper connection to the highway drains. The disused downstream end of the land drains shall be sealed with approved material to the Engineer's satisfaction.

Any land drainage that ultimately discharges into a public sewer will require permission from Northumbrian Water Limited. It is the responsibility of the Developer to obtain this permission.

12.7.1 Field Drains

Field drains shall be of a material approved by the Engineer. They shall be laid with open joints to straight and uniform line and level. All excavated material shall be removed from site and the trenches filled with approved material in accordance with Clause 12.7.2 and Table 12.7.1.

12.7.2 Stone Backfill to Field Drains

The material used for surrounding field drains and backfilling trenches shall consist of hard clean crushed rock, crushed slag or gravel having a soaked 10% fines value of not less than 100kN and a soundness of greater than 75. It shall be uniformly grading within the grading limits given in Table 12.7.1.

TABLE 12.7.1

BS SIEVE SIZE (mm)	PERCENTAGE BY MASS PASSING
63	100
37.5	85 – 100
20	0 – 50
10	0 – 20
Uniformity coefficient	<10

12.7.3 Carriageway Sub-Drains

When directed by the Engineer the Developer shall excavate trenches for sub-soil drains under the kerb foundations.

They shall be 225mm under the level of the formation.

Drains are to be formed of 100mm diameter porous pipes laid to agreed lines and regular fall and backfilled using material selected from Table 12.7.1.

12.7.4 Porous Concrete Pipes

Porous concrete pipes shall comply with BS1194 and have a non-porous invert.

12.7.5 Porous UPVC Pipes

UPVC pipes shall comply with BS4660 and have a non-porous invert.

12.7.6 Silt Pits

The silt pits should be constructed to give a minimum internal width of 900mm and a minimum internal length of 1500mm. The Engineer may request for these dimensions to be increased depending on the pipe sizes.

The walls shall be constructed of 225mm thick Class B Engineering brickwork set on 150mm thick Grade ST4 concrete foundation as detailed in sketch 12.7.1.

12.8 PROTECTION OF EXISTING WATERCOURSES

The Developer shall be responsible for maintaining watercourses within the development in an effective working condition at all times.

If the Developer wishes to culvert any or all of an existing watercourses then they must first gain the consent of the Environment Agency.

12.9 OUTFALL TO WATERCOURSES

The Developer's attention is drawn to the fact that if he intends to discharge highway drainage into an existing beck or ditch then permission must be obtained from the Environmental Agency prior to any discharge taking place.

The Developer is responsible for obtaining all of the necessary permission and consent requirements.

Sketch nos. 12.8.1 to 12.8.3 show various alternatives for outfall details.

12.10 CCTV SURVEY

The Developer must carry out a full colour CCTV survey of all drains and connections. This shall be supported by a plan of the development indicating the drains surveyed, together with a detailed report on the condition of the pipe indicating the location of debris, faults and junctions. The information should be made available to the Engineer and any remedial works necessary, carried out before the surface course is laid to the carriageway.

12.11 OTHER STRUCTURES

A structure that is required to bridge a watercourse in order to construct a road will be considered for adoption by the Highway Authority. Reference must be made to "The Technical Approval Procedure for Developer's Structures", a copy of which can be obtained from the Engineer.

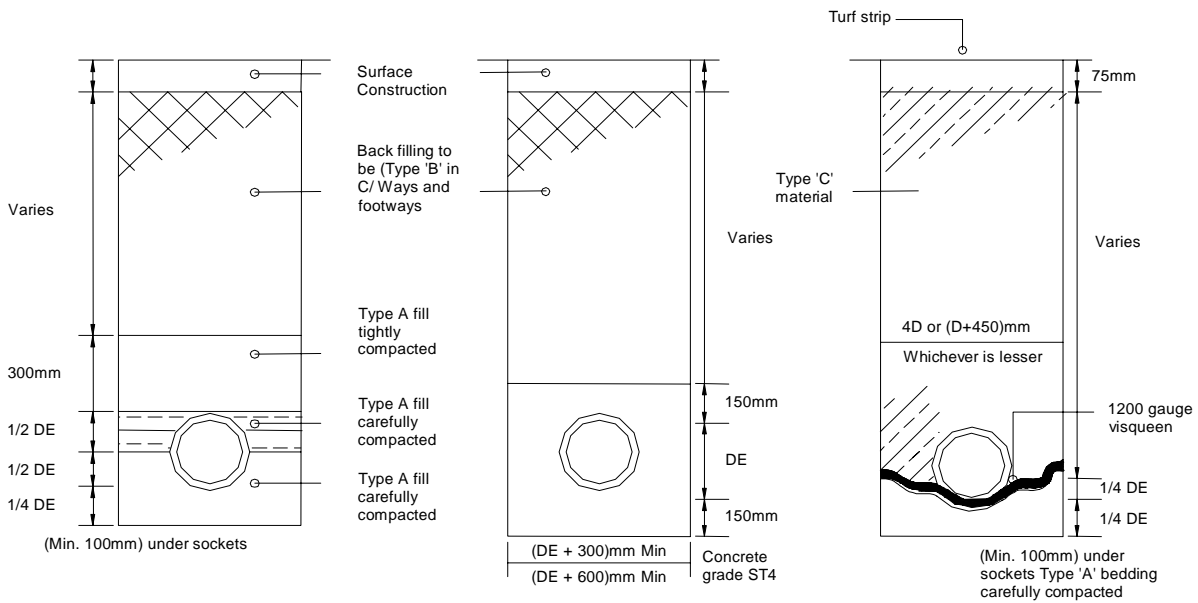

PIPES WITH FLEXIBLE BED AND SURROUND (Class S Bedding)

PIPES WITH CONCRETE BED AND SURROUND (Class A Bedding)
(This detail can be used on UPVC Pipes)

FRENCH DRAINS

Note:- Where design calculations show a higher bedding factor is necessary the granular bed is to be replaced by concrete

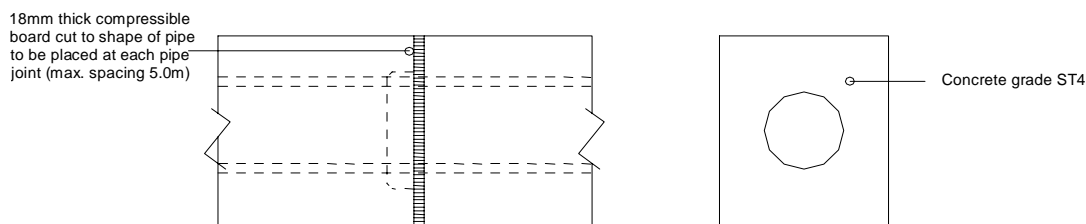

DETAIL OF FLEXIBLE JOINT IN CONCRETE BED AND SURROUND

BEDDING AND TRENCH BACKFILL DETAILS FOR CONCRETE AND CLAY PIPES (For UPVC pipes reference must be made to manufacturers instructions)

Sketch No. 12.4.1

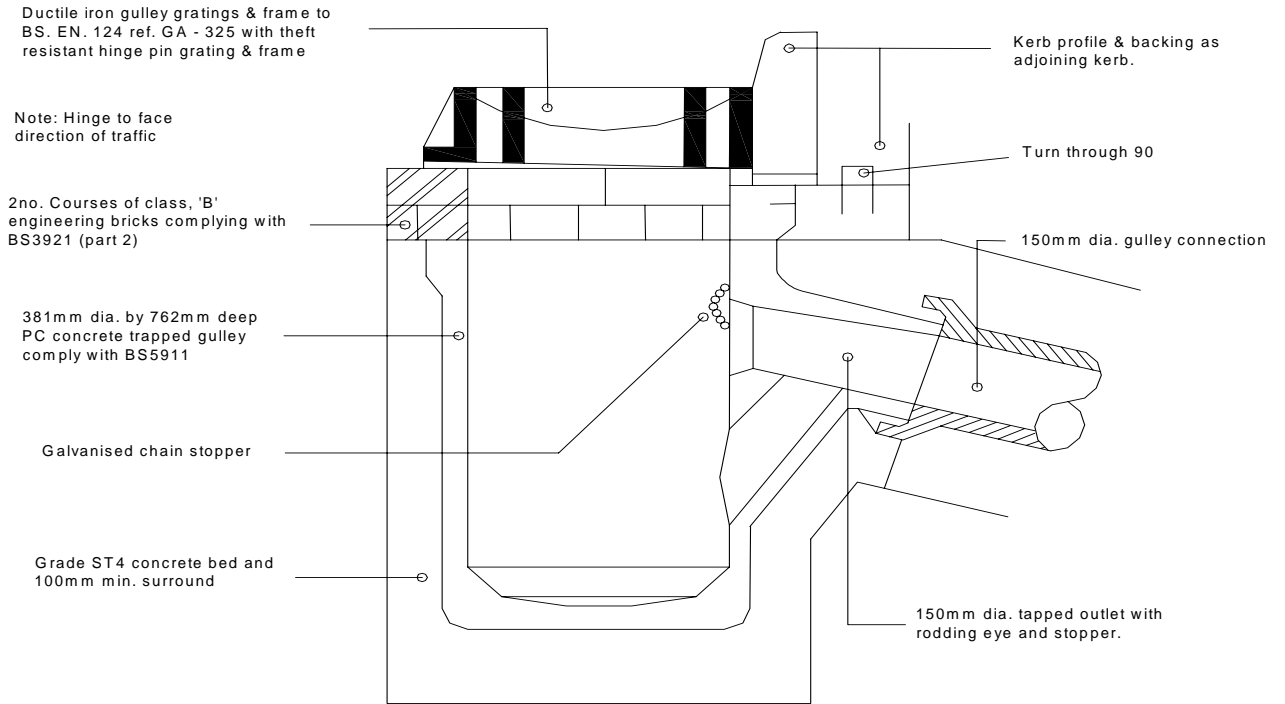

SECTIONAL ELEVATION FACING KERB

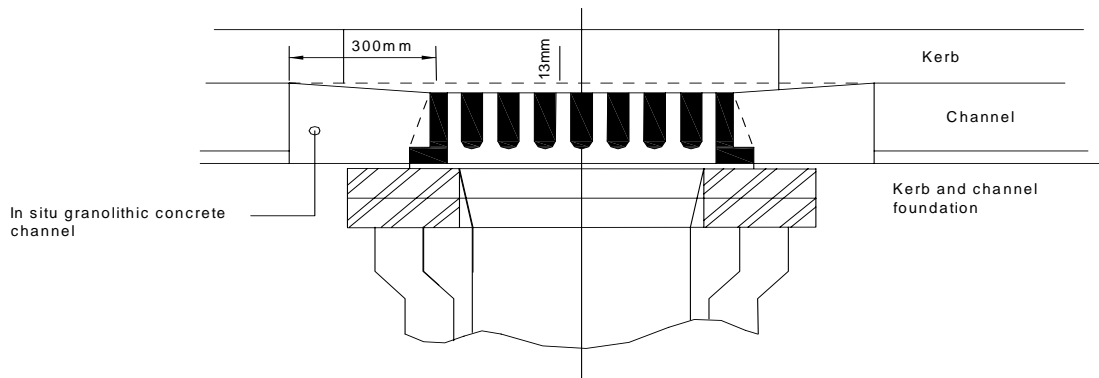

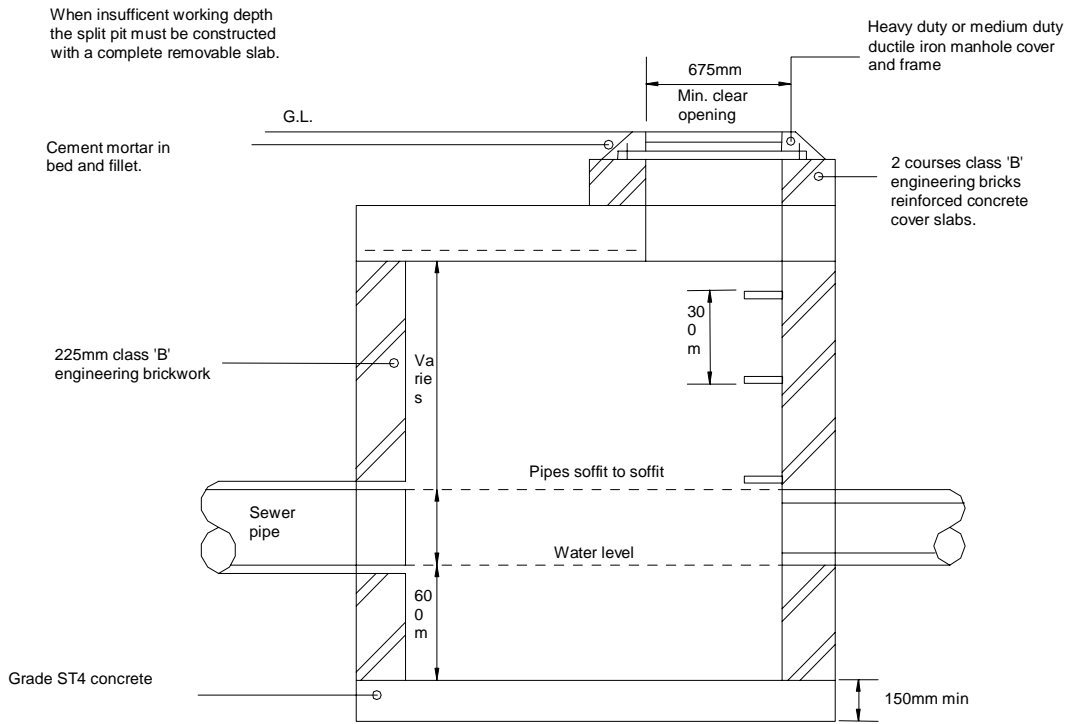

SECTION

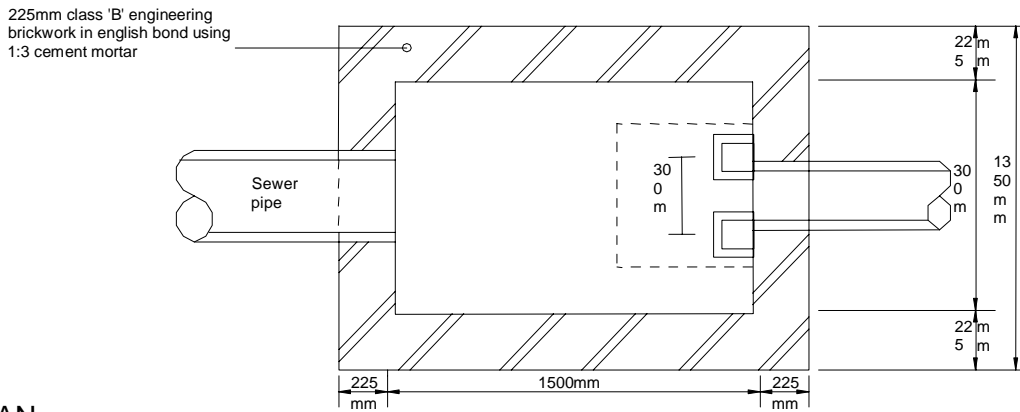

PLAN

NOTES
 The concrete cover slab is to be grade GEN4 with 12mm bars at 150mm centres and diagonal bars across the corners of the 450 x 675mm entry. The brickwork shall have joints finished flush and all internal joints shall be raked out as work proceeds and when complete the wall shall be thoroughly washed down and the joints pointed with a neat flushed joint in cement mortar. In shallow manholes the interior dimensions of 1500 x 900 increasing according to pipe size may be reduced to 900 x 600mm where directed by Engineer.

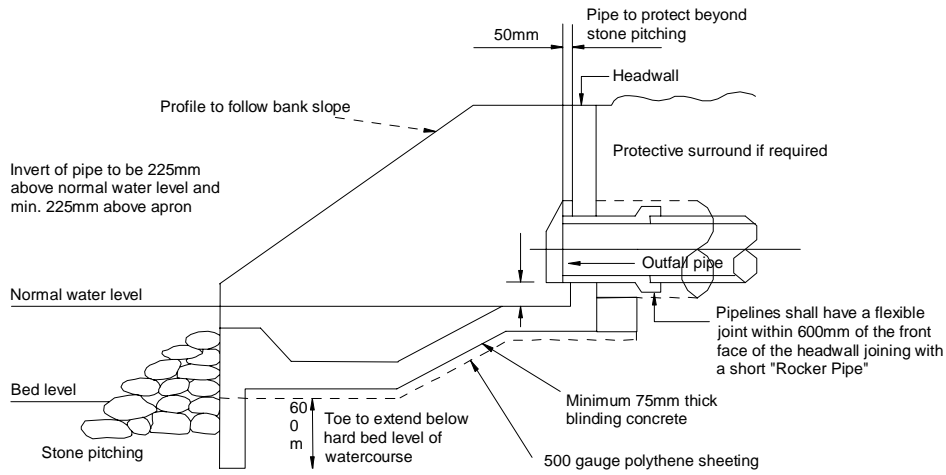

SECTION TAKEN ON LINE A -A

GENERAL NOTES

1. The exact location of the outfall must be indicated.
2. Pipe outfall exit velocity should not exceed 1.2 m/s.
3. The headwall and wingwalls should not project beyond or above the line of the bank.
4. No part of the structure should cut into any flood embankment.
5. All surplus spoil from excavations for structure and pipe must be removed from site.
6. Stone pitching may be required to protect the bed and opposite bank downstream of the outfall.
7. The exact location of the outfall must be indicated.
8. Flap valve to be secured using a minimum of 4 bolts.

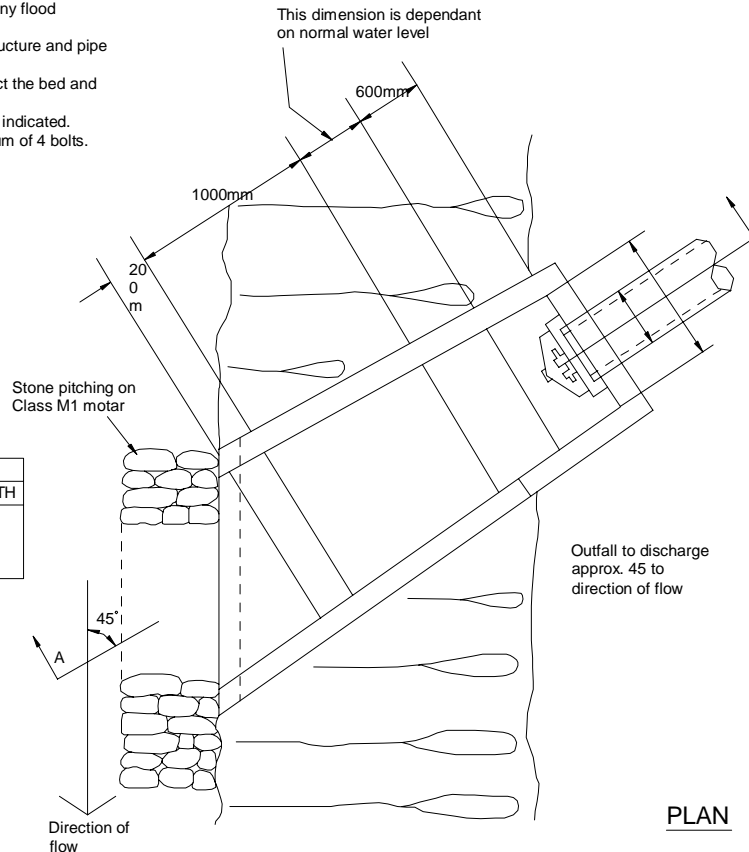

ROCKER DETAILS	
PIPE DIAMETER	ROCKER PIPE LENGTH
150 - 450	500 - 750
500 - 750	750 - 1000
>750	SEEK GUIDANCE

PLAN

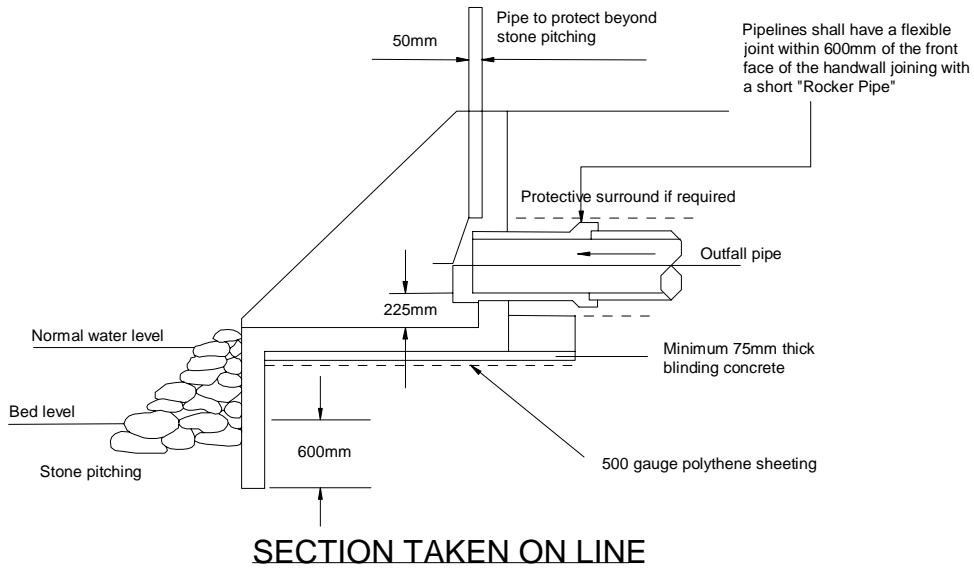

GENERAL NOTES

1. The exact location of the outfall must be indicated.
2. Pipe outfall exit velocity should not exceed 1.2 m/s.
3. The headwall and wingwalls should not project beyond or above the line of the bank.
4. No part of the structure should cut into any flood embankment.
5. All surplus spoil from excavations for structure and pipe must be removed from site.
6. Stone pitching may be required to protect the bed and opposite bank downstream of the outfall.
7. Flap valve to be secured using a minimum of 4 bolts.

ROCKER DETAILS	
PIPE DIAMETER	ROCKER PIPE LENGTH
150 - 450	500 - 750
500 - 750	750 - 1000
>750	SEEK GUIDANCE

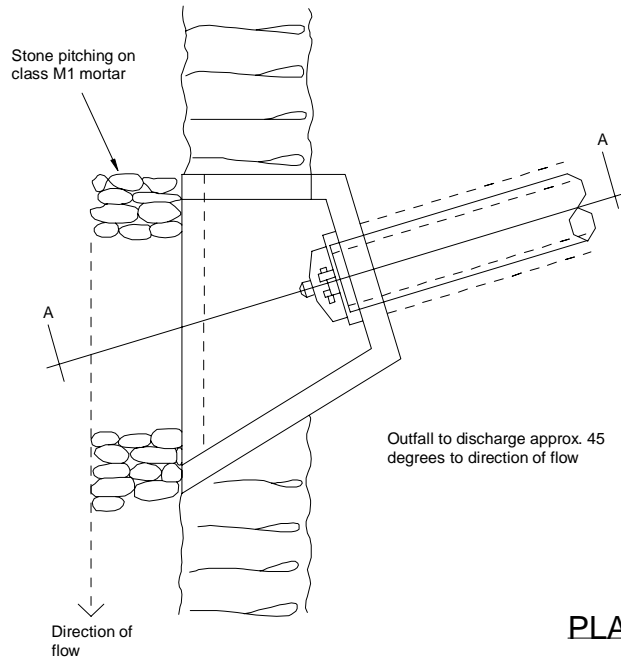

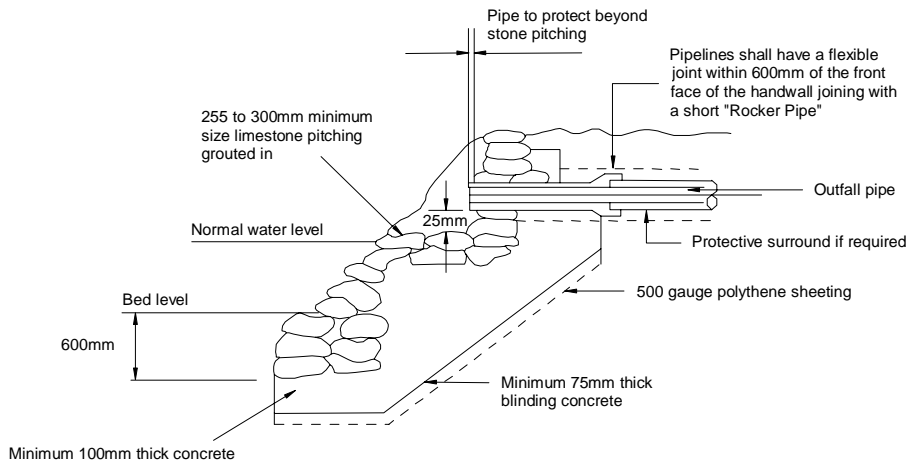

SECTION TAKEN ON LINE A -A

GENERAL NOTES

1. The exact location of the outfall must be indicated.
2. Pipe outfall exit velocity should not exceed 1.2 m/s.
3. The headwall and wingwalls should not project beyond or above the line of the bank.
4. No part of the structure should cut into any flood embankment.
5. All surplus spoil from excavations for structure and pipe must be removed from site.
6. Stone pitching may be required to protect the bed and opposite bank downstream of the outfall.

ROCKER DETAILS	
PIPE DIAMETER	ROCKER PIPE LENGTH
150 - 450	500 - 750
500 - 750	750 - 1000
>750	SEEK GUIDANCE

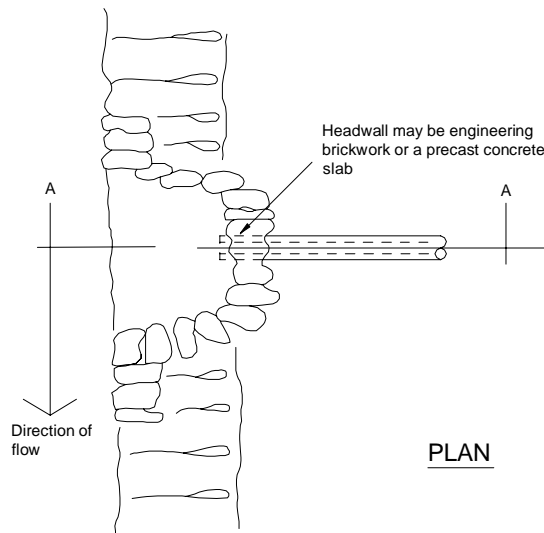

PLAN

CONTENTS

<i>CLAUSE</i>	<i>TITLE</i>	<i>PAGE</i>
13.1	<u>LANDSCAPING</u>	222
13.2	<u>AREAS FOR ADOPTION</u>	222
13.3	<u>DESIGN REQUIREMENTS</u>	222
13.4	<u>PREPARATION FOR FORMATION AND SOILING</u>	223
13.5	<u>EXISTING VEGETATION</u>	223
13.6	<u>DEMOLITIONS</u>	224
13.7	<u>SOILING</u>	225
13.8	<u>TOPSOIL</u>	225
13.9	<u>STREET FURNITURE AND MOWING STRIPS</u>	226
13.10	<u>WALLS AND FENCES GRASS CUTTING</u>	226
13.11	<u>APPLICATION OF WEED KILLER OR OTHER CHEMICALS</u>	226
13.12	<u>CULTIVATION FOR GRASS SEEDING</u>	226
13.13	<u>GRASS SEED</u>	227
13.14	<u>FIRST CUT</u>	227
13.15	<u>MAINTENANCE – GRASSED AREAS</u>	227
13.16	<u>TURFING</u>	228
13.17	<u>TREES AND SHRUB SELECTION</u>	229
13.18	<u>TREES</u>	229
13.19	<u>SHRUBS</u>	230
13.20	<u>TREE AND SHRUB PLANTING</u>	231
13.21	<u>MAINTENANCE OF PLANTED AREAS AND TREES</u>	232
13.22	<u>ADOPTION PROCEDURE</u>	232

13.0 HIGHWAY VERGES

13.1 LANDSCAPING

For the purpose of this Design Guide and Specification 'landscaping' shall mean; all soft landscaping works including soiling, seeding, ground preparation, planting, protection and maintenance of existing or proposed trees or shrubs.

13.2 AREAS FOR ADOPTION

Areas for adoption as Highway Verge by the Highway Authority should be clearly defined on plans and where necessary separated from private gardens by edging kerbs set in the boundary at ground level.

Verges contiguous with front gardens, which provide for the accommodation of services and lighting in "shared surfaces" will be adopted.

Similarly areas for consideration of adoption by the authority as public open space should be clearly defined on plans. There is no guarantee that such areas will be adopted although a clear indication as to the Authority's position will be given as part of the development control consultation process.

The Highway Authority will adopt verges contiguous with the carriageway and which are provided in lieu of footways for the accommodation of statutory undertakers services and public lighting. Such verges shall have a minimum width of 1.8m and where necessary cater for the requirements of sight line visibility.

Grass areas should not be less than 1m wide and shrub areas where there are hard surfaces on both sides should not be less than 2m wide.

Hedges and fences will not normally be adopted as part of the public highway or public open space and shall remain the responsibility of the adjacent landowners or householders. This said existing hedgerows should not be lost within the confines of new boundary fences but should remain part of the curtilage of the property as defined on official deeds.

13.3 DESIGN REQUIREMENTS

Grass areas should not be less than 1m wide and shrub areas where there are hard surfaces on both sides should not be less than 2m wide.

Verges must be designed so that any surface water run off discharges to the highway or onto an adoptable piped system.

Footpaths should in general follow the line most people would wish to walk. Right-angled corners on footpaths across grass areas should be avoided. Where new pedestrian desire lines appear during the maintenance period the Developer shall carry out all works found necessary to resolve problems as directed by the Engineer.

Sloping grass banks steeper than 1 in 3 should be avoided in accordance with BS 4428. Slopes should be 1 in 5 or flatter. Tops and toes of embankments should be rounded to facilitate mowing. (See Clause 5.2.15).

13.4 PREPARATION OF FORMATION AND SOILING

Prior to any form of soft landscaping all of the areas must be cleared of bricks, hard-core and any other debris over 50mm in dimension all of which shall be removed from site. Any areas contaminated by fuel storage, concrete mixing etc. must be excavated and backfilled with clean soil in accordance with appropriate specifications described below.

Clean subsoil should be used to form shapes indicated by contours on the landscape drawings. The areas should then be broken up with a surface ripper to a 600mm depth with the tine spacing set at 500mm centres and any further debris arising of 50mm diameter or greater removed from site.

The areas should then be spread with approved topsoil from stock, providing it meets the requirements of BS 3882, care being taken. Using the landscape drawings as a guide the following depths of approved topsoil should then be provided.

- | | | |
|-------|-------------|---------------|
| (i) | Shrub areas | 450mm minimum |
| (ii) | Grass areas | 150mm minimum |
| (iii) | Trees | 600mm minimum |

Formation levels should be such that finished level will be:-

- (i) 30mm above level with paving or kerb levels, following settlement where seeding or turfing is to occur.
- (ii) 150mm below DPC of adjoining buildings.
- (iii) 225mm below DPC of adjoining buildings when a mulch is to be applied.
- (iv) 75mm below paving or kerb levels and dished back from 0.5m where a mulch is to be applied to shrub or tree planted areas.

NB: 0.5m wide hard surface strip should be adjacent to any building to facilitate maintenance/window cleaning.

13.5 EXISTING VEGETATION

Under normal circumstances the protection of trees (and hedges) and permitted works to trees or hedges will be covered by specific planning conditions which will normally include:-

- (i) The requirement of developers to submit detailed tree (and hedge) condition surveys prepared by a professional Arborist or similarly qualified Landscape Professional who shall make independent recommendations for appropriate works to trees or hedges to be retained, for consideration by the Engineer.

- (ii) The requirement of developers to submit a detailed survey plan indicating the position of all trees and proposed developments, the canopy spreads of existing trees, and existing and proposed levels. The trees (hedges) to be retained or removed are to be clearly identified on submitted plans.
- (iii) A scheme of tree protection generally in accordance with BS 5837:1991.
- (iv) Method statements for construction works and foundation design and for the provision of services and excavations to facilitate construction where approved, within the canopy spread of trees to be protected.
- (v) Full details of trees to be replanted as substitutes for those to be removed on approval including, name, size, planting and maintenance specifications.

The above said, and where not specifically referred to when planning conditions relating to the site, this Specification shall apply.

The Developer must protect existing trees on the site, in accordance with BS 5837:1991 "Trees in relation to construction". Site procedures and practice must avoid problems such as soil compaction, changes in soil levels, changes in the water table, root disturbance by excavation, spillage of chemicals, fire damage, physical damage and the storage of materials in close proximity to trees. All of which are not to be permitted and could lead to die back, death and potential failure of existing trees with corresponding Health and Safety and legal liability arising.

A protective fence of an approved specification, extending to 3.0m outside the perimeter of the trees canopy must be erected in accordance with BS 5837 : 1991 "Trees in relation to construction".

Where it is essential that ground services are routed within the protected area around the tree, the excavation must be carried out by hand, taking precaution so as not to sever roots greater than 25mm diameter. Services should under normal circumstances be routed directly under the centre of a tree by tunnel boring to minimise damage. Reference should be made to the 'Guidelines for the Planning Installation and Maintenance of Utility Services in Proximity to Trees'. NJUG – April 1995 and any other relevant guidelines.

13.6 DEMOLITIONS

Buildings, walls, roads, foundations, disused drains, manholes and any other construction not needed should be demolished to minimum depths below finished levels, as follows:-

- (i) grass areas: 450mm
- (ii) ground cover and perennial planting areas: 450mm
- (iii) shrub planting areas: 600mm
- (iv) tree planting (within the estimated root zone of the mature tree): 1.0m

All material should be removed from the site.

Below the depths given in (i) to (iv), concrete slabs or other impervious layers should be assessed for size and depth so that the Engineer can decide as to whether the slabs or layers should be broken up to facilitate free drainage, or whether they should be removed from the site to obviate future drainage problems. When subsoiling and drainage operations are to be carried out involving depths below those mentioned in (i) to (iv), consideration should be given to the need for demolition work to be carried out to lower levels, to ensure that effective drainage operations can be carried out.

13.7 SOILING

All soiling, sowing and planting shall be carried out in accordance with BS 4428. Imported subsoil shall be of agricultural origin and shall be free from weeds, sticks, stones and other deleterious material. Clay subsoil and heavy clay topsoil shall be deemed unacceptable. No soil shall be brought on site without the prior inspection and approval of the Engineer and the Developer shall give 24 hours notice of his intention to import soil on to the site. The Developer shall be required to provide evidence/proof of origin for any soil imported onto site.

13.8 TOPSOIL

Topsoil and subsoil stored temporarily on site shall be conserved in heaps not more than 1.5m high deposited by retreat. The Developer shall keep soil heaps free from contamination by weeds, other materials or sources at all times.

The topsoil heaps may be planted with an approved ley crop, if the landscape works are not to take place for more than 12 months stockpiling. If a ley crop were to be planted the Developer must ensure that the crop is uniform and not encroached by weed species.

Prior to spreading topsoil, the formation level shall be graded to the levels indicating on the drawings. Grading shall take place in layers not exceeding 150mm consolidated thickness. Soil shall only be served in dry conditions and when the soil is not water logged. Only tracked vehicles shall be used to avoid unnecessary compaction.

Final levels, after reasonable consolidation shall be 30mm above adjoining pavings, kerbs, manhole covers. Where shrub beds are proposed, however, topsoil levels shall rake down to 75mm below finished paving levels to facilitate the spreading of 75mm settled depth of specified mulch.

Topsoil shall be good quality to BS 3882 free from deleterious matter and shall have been approved by the Engineer prior to delivery to site. It shall be fertile, with a humus and fibre content and shall have a good crumb structure.

Topsoil shall be defined as the original surface layer of grassland or cultivated land. It shall not contain an excessive amount of weed seed or roots of perennial weeds and it should be of a darker colour than the subsoil it overlies because of its organic content.

The Developer shall apply repeated applications of non-hazardous systemic herbicide such as alyphosate to kill any emerging weeds prior to seeding, turfing or planting.

13.9 STREET FURNITURE AND MOWING STRIPS

Street furniture, manhole covers and service boxes or other approved hard surface sited in verge areas must be surrounded with 225mm minimum by 100mm thickness of Grade ST4 concrete mowing strip to facilitate grass cutting operations except for street nameplates which must also extend under the nameplate. A float or brush finish is required and finished level should be 30mm below the ground level.

13.10 WALLS AND FENCES GRASS CUTTING

Wherever grass is sown next to a wall or fence a mowing strip consisting of 300mm x 100mm thickness of grade ST4 concrete or similar approved paving material shall be constructed against the wall or extending underneath the fence and at a finished level 30mm below finished ground level.

13.11 APPLICATION OF WEED KILLER OR OTHER CHEMICALS

Weed killers approved by the Engineer should only be applied using the rate of application and safety precautions recommended by the manufacturer. The Developer must take all necessary precautions to avoid drift onto existing trees, shrubs, neighbouring property, and contamination of any watercourse. The Developer must ensure that all chemicals are clearly labelled and locked away out of reach of children and animals and away from all feeding stuffs.

All operations and uses must comply with the regulations applying to COSHH. All operatives must be fully trained and certified accordingly to the Control of Pesticides Regulations and all other legislation.

Any weed killer or other agricultural chemical used on the site must be contained in the Ministry of Agriculture's list of approved products and the current edition of 'Pesticides' published by HMSO. The UK Pesticide Guide by the British Crop Protection Council.

<p>Note: In general the local authority would advocate the use of a non-hazardous systemic glyphosate based herbicide used in accordance with manufacturers instructions.</p>
--

13.12 CULTIVATION FOR GRASS SEEDING

The whole of the area to be grassed should be cultivated to relieve compaction and to produce a fine surface tilth.

Where possible heavy clay soils should be ploughed in the autumn to allow breakdown of clumps by winter frost and in spring they should be cultivated as described above.

Where appropriate light clay soils may be cultivated in the summer for an autumn or a spring sowing.

Cultivation should never be carried out during wet weather or when the soil is excessively wet, or in any condition likely to cause damage to the soil structure.

During this operation, all surplus vegetable matter and all surface stones having one dimension exceeding 50mm are to be collected and disposed of to tip off site. During the seedbed cultivation fertiliser approved by the Engineer shall be worked into the topsoil at a rate of 35 g/m².

Seed shall be evenly sown in 2 directions and lightly harrowed or hand raked into the surface.

13.13 GRASS SEED

A suitable grass seed mixture approved by the Engineer and spread the rate of 35 g/m² shall be used for:-

- (i) Highway Verges, Traffic Islands, Central Reservations
- (ii) Steep slopes and Embankments

Grass seed must be fresh and proof of origin, purity and germination potential must be provided to the Engineer on request.

An appropriate low maintenance, hardwearing, slow-growing grass mix is as follows:-

60% Lisabella Perennial Ryegrass 35% Liprosa Slender Creeping Red Fescue 5% Highland Browntop Bent

13.14 FIRST CUT

The seeded areas shall be mown when the grass is 100mm high, reducing to 50mm height. On completion of the first cut, the areas will be stone picked and all extraneous matter exceeding 38mm diameter will be collected and carted away. Any bare areas shall be lightly re-sown.

13.15 MAINTENANCE – GRASS AREAS

During the maintenance period the Developer shall be responsible for undertaking with due care, and generally in accordance with BS 3975, Part 5, and BS 4428, all operations required to ensure the establishment and maintenance of a weed free sward.

Pernicious weeds shall be treated with suitable “new grass” selective weed killer applied 12 weeks after seeding if the grass was sown in Spring. Grass sown in the Autumn shall to be similarly treated at the end of May the following year.

During the growing season, further cuts shall be given at a maximum of 4 week intervals prior to final adoption.

13.16 **TURFING**

Turf should be good quality meadow turf, complying with BS 3969, fibrous, well-rooted, mown and free from matted or dead grass and pernicious weeds. Turves should be of rectangular shape and of uniform thickness. Unless otherwise agreed by the Engineer it should have a minimum thickness of soil of 25mm and a width of 300mm.

Turfing should be carried out in accordance with BS 4428.

Turves should be delivered at appropriate intervals throughout the work so as to avoid, as far as possible, stacking for long periods. No turf should be laid in exceptionally dry, frosty or otherwise unsuitable conditions.

The turves should be laid on the prepared soil bed and firmed into position in consecutive rows with broken joints, closely butted and to the correct levels. The turf should be laid off planks working over and evenly firmed with wooden beaters, the bottom of the beaters being frequently scraped clean of accumulated soil or mud. Any inequalities in finished levels owing to variation in turf thickness or uneven consolidation of soil should be adjusted by raking and/or packing fine soil under the turf. The finished levels of the turf should conform to the levels indicated on drawings allowing for final settlement. Turf abutting paving or kerbs should be approximately 25mm above the adjacent hard surface after laying and beating operations.

A top dressing of finely sifted loamy topsoil or fine peat substitute of 6mm depth should be applied and well brushed in on completion of turf laying.

Turf edges to borders, beds and margins should be carefully trimmed square and true to line and curve as detailed.

On completion of turfing all areas should be watered thoroughly to avoid shrinkage. The Developer will be responsible for the replacement of any areas of failed turf at his own expense.

13.17 TREE AND SHRUB SELECTION

Detailed comments regarding the appropriate selection of trees and shrubs on individual development sites will normally be given as part of the development control process. Only selected species of trees will be permitted within the highway verge and early consultation with the Engineer is essential. However, developers are reminded that the landscape design and plant selection must take into account the mature size and habit of trees and shrubs. They should be sited to allow them to achieve reasonable maturity without having deleterious effects on their surroundings, or vice versa. Full consideration should be taken for the plants demands, its proximity to buildings and services, and the effects large plants may have on buildings. The recommendations of BS 5837:1991 "Trees in relation to construction" should generally be followed in all cases.

Generally the use of thorny material next to paths windows or the use of poisonous plants should be avoided.

13.18 TREES

The size, type and location of trees to be used shall be agreed with the Engineer and be in accordance with the general principles of BS 5837 "Trees in Relation to Construction". Generally trees shall meet the requirements as given by Appendix A of this British Standard:-

Size – short to medium
(S/M) Shape – narrow
(N) Water element – low (L)

Any trees in the problem category DR will not be acceptable.

For standard to heavy standard trees, pits shall be rootballed and planted in 1.0m x 1.0m x 1.0m deep pits.

For light standard to selected standard trees, pits shall be 650mm x 650mm x 600mm deep.

All pits shall be backfilled with a 2 to 1 volume mixture of topsoil and tree planting compost which shall be pre-mixed before placing in the planting pits.

Stakes (larch and chestnut peeled) shall be set 600mm above ground level and not less than 75mm diameter at the butt and pointed at the lower end. Trees shall be tied to stakes with a single expandable rubber tree tie of a size and strength suitable to the purpose and fixed at the top of the stake with a single galvanised dart nail.

All work and materials specified for the planting of trees shall, where applicable, be carried out in accordance with BS 4428, General Landscape Operations, Section 7 and 8: BS 3936, Part 1, Nursery Stock (Trees and Shrubs) and Part 4, Nursery Stock (Forest Trees) and BS 3998, Recommendations for Tree work.

The preferred new trees for planting in residential and industrial estates will minimise the risk of future highway maintenance problems.

Appendix A of BS 5837 gives only a small number of species that are suitable for highway planting there may however be other species which are acceptable. Early discussions with the Engineer to clarify the local appropriateness of species is recommended.

If the Developer intends to use trees other than those suggested within the BS they should consult with the Engineer at an early stage and should give information on:-

- (i) size
- (ii) shape
- (iii) growth rate
- (iv) water demand

13.19 SHRUBS

Where shrubs are to be planted in existing or topsoiled areas, the ground shall be completely cleared of grass and weeds by approved methods.

Shrub areas shall be cultivated by hand or rotavator to depth of 300mm incorporating three planting compost at a rate of 40 l/m² and approved fertiliser at 100 g/m² of shrub area. Stones exceeding 50mm diameter, roots and any other extraneous matter shall be collected and removed from the site.

Bare rooted shrubs shall have been undercut and, according to species, cut back to 250mm or trimmed to encourage bushiness. They shall be graded for size which should be stated. If pot grown or containerised shrubs are used then the size of the container should be stated and also the height from ground level. Density of planting shall be appropriate to the type of species the size of planting and the site conditions. Advice will be given at the planning stage as part of the development control process. Generally speaking however 1 litre shrubs will be planted at 7 plants per m² while 2 litre and 3 litre will be planted at 3 to 4 plants per m² depending on size.

Where container grown plants are indicated the plants shall have been established in the containers long enough for substantial new growth to have been produced within the container. A volume in litres must be shown on planting plans and the capacity of container used must be at least that capacity.

Plants shall be obtained from approved nurseries, preferably located in the north of England or Scotland, for best results and comply with the requirements of BS 3936 Part 1.

The various types of shrubs which may be used together with minimum heights at planting are to be agreed with the Engineer.

13.20 TREE AND SHRUB PLANTING

The Developer should note that no tree planting will be generally permitted within the area 4m from the kerb edge of any road to be adopted. However where a root barrier of the type and to a depth, to be approved by the Engineer, is provided, then the distance may be reduced to an absolute minimum of 2m depending on the variety of tree specified. The root screen must extend at least 0.5m below the possible root depth from ground level.

All work and materials specified in this section shall, where applicable, be carried out in accordance with BS 4428, General Landscape Operations, Section 7 and 8; BS 3936, Part 1, Nursery Stock (Trees and Shrubs) and Part 4, Nursery stock (Forest Trees) and BS 3998, Recommendations for Tree Work and BS 4043 Transplanting Root Balled Trees.

It is advisable that bare root plants have their entire root system dipped in a thoroughly mixed proprietary water retaining Polymer based Root Dip immediately on lifting in the nursery, in accordance with manufacturers instructions.

All plant material is to be wrapped in black plastic bags (NB: the local authority would advocate the use of black lined/white outer heavy duty plastic bags for the transportation of stock) at the supply nurseries to ensure that there is no drying, sweating or any damage in transit between the growing nursery and planting out.

Trees and shrubs shall be supplied with protection in accordance with the recommendation of BS 3936. After delivery, if planting is not to be carried out immediately, balled plants shall be placed 'cheek-to-cheek' and root balls covered with straw, soil, sand or moist compost and hessian sheets to prevent drying out. Bare rooted plants must be 'heeled in' by placing the roots in a prepared trench and covering them with soil or compost, which shall be watered in to avoid air pockets round the roots. If for any reasons the surface of the roots becomes dry they shall be rejected and replacement stock used. If planting is to be delayed for more than a week, packaged plants shall be unpacked, the bundles opened up and each group of plants 'heeled in' separately and clearly labelled.

Unless otherwise agreed by the Engineer, planting will take place during favourable weather and soil conditions from the first week in November to the first week in March. No planting operations shall take place when the ground is frost bound, covered in snow, excessively wet or waterlogged or in excessively windy conditions.

All plants shall have good fibrous root systems, carefully preserved in good condition when lifted from the nursery and the Developer shall at all times take appropriate measures to prevent any drying out by covering the plants with hessian or similar approved material.

13.21 MAINTENANCE OF PLANTED AREAS AND TREES

During the maintenance period the Developer shall be responsible shall be responsible for undertaking with due care, and generally in accordance with BS 3975, Part 5, and BS4428, all operations required to ensure the establishment and maintenance of healthy and vigorous plants.

Following frost or strong winds the Developer shall inspect all plants and firm as necessary.

Stakes and ties shall be checked monthly to ensure that they are functioning as intended and replaced if necessary. During this check, the Developer shall ensure that ties are tensioned correctly and that there is no bark chafing.

The Developer shall be responsible for keeping all shrub areas and tree stations to a 1m diameter entirely free of weeds during the maintenance period. Strimmers should never be used around the base of trees because of the danger of bark damage and corresponding tree deaths.

The Developer shall be responsible for watering all stock during the maintenance period on at least 3 occasions or when needed in times of drought (drought defined as 10 consecutive days with little or not appreciable rainfall).

During April/May following planting the Developer shall apply an approved fertiliser to all planted areas at the rate of 100 g/m² of shrub/whip and 50 g/m² of standard/heavy standard trees.

The Developer's attention is drawn to the sever damage which is caused to the bases and trunks of newly planted trees by grass cutting operations. Any such damaged trees may be rejected on inspection and will lead to delays in adoption until replacement trees are established.

13.22 ADOPTION PROCEDURE

Where areas are to be offered for adoption as public open space or as part of the adopted highway then on completion, the Developer will carry out the following operations before handover:-

- (i) Ensure that all shrub beds and tree stations are entirely free of weeds.
- (ii) Ensure that all litter and other debris is removed from site.
- (iii) Ensure that all planted areas are topped up with mulch to 75mm settled depth where mulch has been specified.
- (iv) Ensure that beds are edged up where bordering grassed areas.
- (v) Ensure that all stakes and ties are removed from trees unless otherwise agreed by the Engineer.
- (vi) Undertake pruning of all die back on trees and shrubs.

- (vii) Ensure that all dead or dying plants (including those subject to vandalism) are replaced in accordance with the original specification.
- (viii) Ensure that all agreed commuted lump sums are paid to the adopting authority.

CONTENTS

<i>CLAUSE</i>	<i>TITLE</i>	<i>PAGE</i>
14.1	<u>GENERAL</u>	234
14.2	<u>DESIGN</u>	234
14.3	<u>MANUFACTURE</u>	235
14.4	<u>ERECTION</u>	235

14.0 STREET NAMEPLATES

14.1 GENERAL

Within 4 weeks of commencing work on site, the Developer must submit to the Engineer 2 copies of the detailed site layout showing the proposed naming and numbering for approval. When the scheme has been approved, the Developer must supply to the Engineer a negative to a 1 to 1250 scale showing full details of the street names and house numbers.

The Developer must supply and erect temporary nameplates to the satisfaction of the Engineer, before the first dwelling is occupied. Permanent street nameplates are to be provided and fixed by the Developer on completion of the works.

14.2 DESIGN

The design of the street nameplates must be in accordance with the requirements of the Department for Transport "Traffic Signs Regulations and General Directions". The Developer must submit design proposals to the Engineer for approval.

The background shall be a non-reflective white material with a 12mm black border.

The primary lettering shall be in upper case black Kindersley letter 89mm high or MOT 100mm high.

Secondary lettering shall consist of:-

- (a) additional street names in upper case black Kindersley letters 51mm high or MOT 50mm high.
- (b) additional lettering and numerals in lower case black Kindersley 51mm high or MOT 50mm high.
- (c) where required by the Engineer a street postcode shall be included with Kindersley letters 20mm high located in the bottom right-hand corner.

Directional arrows and other symbols should be black and appropriately sized.

Where the road has no secondary access, a 'No Through Road' sign coloured red and white on a blue background must be added to the nameplates at the junction with the through road.

14.3 MANUFACTURE

The nameplates shall be manufactured so as to provide a complete unit comprising sub-surface graphics with a bonded back plate. Sign frames shall be constructed from mild steel and be formed into a solid backed rebated tray with a minimum rebate depth of 12mm. The faceplate should be reverse printed clear polycarbonate (or similar) with a reinforced glass fibre backing plate of 4mm thickness.

A minimum of one 25mm x 25mm box section stiffener will be attached to each tray with additional stiffeners being provided to ensure a maximum clear spacing between adjacent members of not more than 200mm and a maximum distance from top and bottom edges of 50mm.

14.4 ERECTION

Location of all nameplates should be agreed on site before erection.

- 14.4.1 Freestanding - Nameplates may be set by the following methods:-
- (a) Tubular steel posts 76mm O/D provided with a cap and base plate. The posts should be set a minimum 450mm below ground with a minimum 150mm of ST4 concrete surround.
 - (b) Reconstituted plastic posts with tamperproof mechanical fixings to form a fully composite structure, with ground fixing as in (a) above.
 - (c) When fixed in a grass verge the concrete surround should be as detailed in Clause 13.9.
- 14.4.2 Wall-Mounted - The nameplate is to be drilled, plugged and secured with tamperproof fixings. When erected below 2.5m the nameplate is to be protected in an enamelled mild steel or galvanised tray.